



# GSA PRICE LIST 2023

SUGGESTED GSA NET PRICING  
OCT 2023 | 1ST EDITION

**GSA DISCOUNT**

52% off List Landed  
BC/ST Series are not on  
OM Seating's GSA Schedule



All products in this Price List  
are BIFMA LEVEL® 2 certified



# Available Products

## Task, Light Multi-Taskers, Conference & Stools



Affirm Cushioned (AF)



Affirm Mesh (AF)



Budget Contract (BC)



CE2 (CE2, CE2-P)



Classic: Exam Room Stools (CL)



Classic Lab Stools (CLS)



Classic Task (CL)



Discovery Back (DB)



Ginny Multi-Tasker (GY4-T, GY4-TS)



Intensive Use 24/7 (IU)



Intensive Use HD (IUHD/PD)



Lórien® (LN5, LN5-TS)



Maxwell IU (MXIU/PD)



OM5 Active® Multi-Tasker (OM5-AT, OM5-ATS)



OM5 Series® (OM5)



Paramount Value Series (PT)



Paramount (7\_ \_ \_)



Patriot Collection (PA, PC)



Plot Twist™ (PLT)



Truly® (TY)



Workstools (WS)



Werksy® Multi-Tasker (WY2-T, WY2-TS)



Yes Series (YS)

## Guest, Nesting, & Stacking Chairs



Affirm (AF)



Budget Contract (BC)



Ginny (GY4-G, GY4-B)



OM5 Active® (OM5-AC, AG, AN, AS)



Paramount Value Series (PT)



Patriot Series (PA)



SG Series (SG)



ST Series (ST)



Tibidi® (TD2)



Werksy® (WY2-G, WY2-4S, WY2-R)



Yes Series (YS)

# Table of Contents

in Alphabetical Order



Welcome, to chair-adise! I'm Ozzie, your guide to this book...  
(p.s. visit [omseating.com](http://omseating.com) for current updates)

Affirm series (AF)	AF408 - AF589	9 - 22
BC Series (BC)	BC41 - BC86	23 - 28
CE2	CE2 - CE2P	29 - 33
Classic Professional Series (CL)	CL12 - CL48EZ	34 - 39
Classic Lab Stools (CLS)	CLS53 - CLS61	41 - 42
Discovery Back Series (DB)	DB52 - DB78	43 - 47
Ginny (GY4)	GY4-G, GY4-B, GY4-T, GY4-TS	49 - 57
Intensive Use 24-7 Series (IU)	IU54 - IU76	59 - 61
Intensive Use 24-7 Heavy Duty Series (IUHD/PD)	IU76HD/PD - IU79HD/PD	62 - 63
Lorien® (LN5)	LN5, LN5-TS, LN5-4S	64 - 73
Maxwell Intensive use 24-7 (MXIU)	MX84IU/PD - MX88IU/PD, 7878MX	75 - 78
OM5 Series® (OM5)	OM5, OM5-EX, OM5-TS, OM5-EX-TS, OM5-XT	79 - 85
OM5 Active® (OM5-A)	OM5-AS, OM5-AG, OM5-AT, OM5-AC, OM5-AN	86 - 99
PAC (PA)	PA53 - PA69, PC53 - PC59	100 - 107
Paramount Value Series (PT)	PT62 - PTYM-XT, 7770 - 7878	108 - 117
Plot Twist™ (PLT)	PLT, PLT-T, PLT-B, PLT-BT	118 - 127
SG Series (SG)	SG1K - SG5K	129 - 132
ST Series (ST)	ST400 - ST400F	133 - 135
Tibidi™ (TD2)	TD2, TD2-S, TD2-F	136 - 143
Truly.® (TY)	TY608 - TY688	144 - 151
Werkysy® (WY2)	WY2-G, WY2-4S, WY2-T, WY2-TS, WY2-R	152 - 163
Workstool Series (WS)	WS10 - WS25	165 - 169
Yes Series (YS)	YS70N - YSYM	170 - 176
<hr/>		
OM Company Information (p. 177)	About OM	178
	Terms & Conditions	179
	Limited Warranty	180
	GSA Contract Information	181
	OM Environmental	182
	Guide To Ergonomic Features	183
	Ultimate Test for Fit	184
<hr/>		
COM COL & Grade-in Fabrics (p.185)	COM, COL & Grade-in Information & Specifications	186
	Guide To Grade-In Program	187
	Fabric Application Testing Form	188
<hr/>		
Optional Arm Kits, Arm Tops & Arm Pads	Arm Matrix	190
	Optional Arm Kits	
	Fixed Arms   1D motion arms	191
	1D motion arms	192
	2D motion arms   3D motion arms	193
	3D motion arms   4D motion arms	194
	4D motion arms	195
	4D+ motion arms	196
	Optional Arm Tops and Arm Pads	197
<hr/>		
Mechanism Guide	Mechanism Guide	200 - 201
Optional Casters & cylinders	Caster Options and Guidelines	204 - 205
	Cylinder Options and Guidelines	205
Headrest	Non-standard Upholstered Options	206
Additional Upholstery and Options	Additional Upholstery and Options	207

Please be advised that all prices listed herein are shown at list price, subject to change without notification and do NOT include: assembly charge, installation charge, set-up charge, additional delivery charges or other charges exclusive of the cost of product.

# Table of Contents

by Category (type)

<b>Budget</b>	BC Series (BC)	BC41 – BC86	23 – 28
	Classic Professional Series (CL)	CL44 – CL48EZ	38 – 39
	PAC	PA53 – PA69, PC53 – PC59	101 – 107
	Paramount Series (PT)	PT62 – PTYM-XT, 7770 - 7878	109 – 117
<b>Ergonomic</b>	Affirm Series (AF)	AF408 – AFYM	9 – 22
	Discovery Back (DB)	DB52 – DB78	43 – 47
	OM5 Series* (OM5)	OM5, OM5-EX, OM5-TS, OM5-EX-TS, OM5-XT	79 – 85
	PAC	PC53 – PC59	106 – 107
	Paramount Series (PT)	PT62 – PTYM-XT, 7770 - 7878	108 – 117
	Truly,* (TY)	TY608 – TY688	144 – 151
Yes Series (YS)	YS72 – YS98	170 – 176	
<b>Mesh or Polymer back</b>	Affirm Series (AF)	AF504 – AFYM	13 – 22
	Lorien® (LN5)	LN5, LN5-TS, LN5-4S	64 – 73
	OM5 Series* (OM5)	OM5, OM5-EX, OM5-TS, OM5-EX-TS, OM5-XT	79 – 85
	OM5 Active*	OM5-AS, OM5-AG, OM5-AT, OM5-AC, OM5-AN	86 – 99
	SG Series (SG)	SG1K – SG5K	129 – 132
	ST Series (ST)	ST400	133 – 135
	Truly,* (TY)	TY608 – TY688	144 – 151
	Werkysy® (WY2)	WY2-G, WY2-T/TS, WY2-4S, WY2-R	152 – 163
	Yes Series (YS)	YS70N – YSYM	170 – 176
<b>Guest, Stackable &amp; Collaborative Seating</b>	Affirm Series (AF)	AF411S , AF470N, AF471N, AF511S, AF516S, AF570N, AF571N	12, 20, 21
	BC Series (BC)	BC48S, BC86S	27
	Ginny (GY4)	GY4-G, GY4-B, GY4-T, GY4-TS	48 – 57
	Lorien (LNS)	LN5-4S	72
	OM5 Active*	OM5-AN, OM5-AS, OM5-AG	88, 90, 94
	Paramount Series (PT)	PT70N, PT71N, PT74S, PT76S, PT78S	114 – 115
	PAC	PA61S	105
	Plot Twist	PLT, PLT-T, PLT-B, PLT-BT	118 – 127
	SG Series (SG)	SG1K – SG5K	129 – 132
	ST Series (ST)	ST400 – ST400F	133 – 135
	Tibidi™ (TD)	TD2, TD2-S, TD2-F	136 – 143
	Werkysy® (WY2)	WY2-G, WY2-4S, WY2-R	153 – 157, 162-163
	Yes Series (YS)	YS70N, YS71N, YS71S, YS76S	175
<b>Stools</b>	Affirm Series (AF)	AF413, AF415, AF513, AF515	11, 20
	BC Series (BC)	BC41, BC45, BC47, BC49	26
	Classic Lab & Healthcare (CL)	CL12 – CL35	36 – 37
	Classic Professional (CL)	CL45EZ, CL47	39
	Classic Lab Stools (CLS)	CLS53 – CLS61	42
	Discovery Back (DB)	DB52, DB54, DB56	46
	Ginny® (GY4)	GY4-TS	56 – 57
	Lorien® Collection	LN5-TS	70 – 71
	OM5 Series* (OM5)	OM5-TS, OM5-EX-TS	82 – 83
	OM5 Active*	OM5-ATS, OM5-AC	98, 92
	Intensive Use 24-7 (IU)	IU55, IU73	61
	Intensive Use 24-7 Heavy Duty Series (IUHD/PD)	IU77HD, IU77PD	63
	Maxwell IU 24-7 (MXIU/PD)	MX85IU, MX85PD, MX87IU, MX87PD	77
	Workstool 10 Series (WS)	WS10 – WS16	166 – 167
	Workstool 20 Series (WS)	WS22 – WS25	168
	Truly,* (TY)	TY6-TS	150 – 151
	Werkysy® (WY2)	WY2-TS	160 – 161
Yes Series (YS)	YS73, YS75	174	

Please be advised that all prices listed herein are shown at list price, subject to change without notification and do NOT include: assembly charge, installation charge, set-up charge, additional delivery charges or other charges exclusive of the cost of product.

# What's New

New Product Intros for 2023-2024

## CE2

office, executive & conference

See product details on **p. 29**

- Elegantly-appointed, executive chair available in either a sleek modern or a comfy pillowtop version.
- Simple to use, Body-weight Activated Mechanism.
- Options include adjustable lumbar, headrest, or polished aluminum accents.
- Upholstery ranges from anything in OM Seating's Leathers Program to one of four elegant, in-stock selections.



## Lórien®

office, conference, guest & stool

See product details on **p. 65**

- Features a complete offering of comfortable mesh styles & aesthetics.
- Available in mid- or high-back, and in Modern Black or Cloud White frame with complementary mesh/frame color pairings.
- Shadow Grey "suspension fabric mesh" offers a warmer look & feel than regular mesh.
- Available styles — 2 sizes of 5-star base chair, stool, or lounge.
- Designed by Fiorenzo Dorigo.



## OM5 Active® Nest

nestable & stackable

See product details on **p. 88**

- Effortlessly functional while playfully stylish!
- Stacks 3, nests infinitely, with full articulating seat top.
- Available in our existing & colorful OM5 Active Polyflex colors.
- Designed by Francisco and Nadine Romero of Phidesign.



## Plot Twist®

collaborative & guest

See product details on **p. 119**

- Who doesn't love a great Plot Twist?!
- 3 primary configurations – upholstered swivel seat (i.e. pouf form); upholstered swivel seat with low back support; either form. . . but with an attached, ambidextrous tablet.
- Attached tablet smoothly height-adjusts from sitting to standing/presentation mode with unique, "free-lift" motion.
- Designed by Achella Design



# What's New

## Changes to our Offering

STATUS	ITEM MODEL	REF. PAGE	DESCRIPTION REMARKS AND COMPARABLE MODELS (IF APPLICABLE)
<b>NEW</b>	OM5 Active® Nest	88	New OM5 ACTIVE NEST - Nesting, Stacking, Pivoting! Check out the new addition to our OM5 Active® Family!
	Plot Twist™	119	New PLOT TWIST™ - Sit, Stand, Present! Plot Twist...this is more than just a pouf!
	OM5 Active® Guest - Casters -55MSB, -55MSG	94	Color match your frame down to the casters! We highly recommend specifying -55MSB or -55MSG with modern black or palladium grey frames. Did we mention they're multi-surface as well?!
	Ginny Guest	50	You can now specify your Ginny Guest (GY4-G) with a little bit of pizzaz. We've added a new frame/arm combination, Chrome Frame with Grey Armpads (-CHGR).
	AR82-BLK	29	New Reverse Cantilever arm will soon be available in Black!
	-4a AND -4b Mech on PT Series	110 - 112	We've added Quick-Adjust Synchro Mechs (Simple and Advanced) to select PT Series (PT69, PT74, PT78)
<b>NEW PAGES/ GUIDES</b>	Mechanism Guide	199	Mechanisms can be complicated, we have now added a mechanism guide to help you better understand the difference between each one.
	Fabric Application Testing Form	188	New fabric application testing form and policy is now in place.
	New Pricelist Layout		GINNY, OM5®, OM5 Active®, Truly®, Werksy
	Clearance Page	8	Discounted Last Chance products!
<b>NEW CODE CHANGES</b>	Added Mechanism Description/Code to all relevant models		Affirm, CL, DB, PT Paramount, PA, PC, Yes
	KR240 related frames (EX. KR445, KR465, KR251M ETC.)		KR240 arm frames will now be KR100 so it consistently follows frame heights KR200, KR300
	Truly® and Werksy® Color Code Changes	144 - 163	Due to different polymer materials between series, colors may vary. To eliminate confusion and for better color accuracy when using our colorchips, we decided to rename and recode some colors to differentiate the different colors. There is NO change to the actual color for the Truly. polyback and Werksy polyshell.
	Cylinder/Footing/ Base/Option Codes		Various code changes, please see notes for former codes
	PT-RV mechanisms	110 - 112	PT model codes with -RV on our PT series have now changed to (-2) Executive Synchro.
<b>IMPROVED</b>	DB, IUHD/PD, 7878 - "TLC" (Two-Layer Comfort)	43-46, 62-63 117	Improved Softness from our previous DCS memory foam
<b>PHASE OUT</b>	AR11	8	Fixed cantilever arms. Replace with KR23, AR81
	OM5-XT	84 - 85	OM5-XT (limited quantities...still available while supplies last)
	BC98S	8	BC98S (limited quantities...still available while supplies last)
	KR100-XM, KR200-XM, KR300-XM	8	3D Motion arms (limited quantities...still available while supplies last). Cannot be used for MXIU or IUHD
<b>DISCONTINUED</b>	WS11		DISCONTINUED
	WS15		DISCONTINUED Replace with WS16
	Tool Tray		DISCONTINUED
	ETR-1, KR32		DISCONTINUED. Replace with KR48, AR81
<b>STILL AVAILABLE</b>	CLFT, CLVS		STILL AVAILABLE Both models are removed from the Price List as ultra-specialty models. But, still available for your foot-support and/or stoop-tasking needs. (Inquire with OM for pricing and details)

## Seating Technology for Comfort

### BAM

Body-activated motion

Body-activated Motion (BAM) describes the dynamic ergonomic principals that the OM5 Series\* of seating rides on.

Instead of relying on inconvenient manual adjustments that many chair occupants realistically rarely use (or worse: misuse), the OM5 Series\* dynamically adapts to the user; reclining or pausing in immediate response to cues from the user's own body.

### DB SCAPULAR RELEASE

**THE 'HEALTHY BACK' DESIGN** According to the ergonomists and chiropractors with whom we have consulted, when people are seated in a chair with a full, 'normal' backrest, the body has a natural tendency to hunch forward. This predilection towards 'scrunching' is — with near uniform agreement — recognized as an unhealthy position for the human body to remain in, especially when seen in prolonged seating situations.

**DISCOVERY BACK DESIGN BENEFITS** The special pear-back design of our Discovery Back series is designed specifically to address unhealthy seating postures. With a cut-away design to allow for full rearward travel of the scapula, DB chairs can help users who sit for long hours to develop habits for a healthier back. This is called scapular release.

### TLC™ TECHNOLOGY

Two Layer Comfort



OM Seating's Two-Layer Comfort Seating™ (TLC) Technology is a unique, layered system of dual ILD foam — combining a conforming, soft outer layer, with a firmer core layer of OM Seating's high-resilience cushioning. Years of research and development have resulted in a seating experience that is at once soft and supportive, and truly beyond compare.

The TLC™ Technology seat cushion has achieved excellent results when put through a series of 'seating durability tests. The seat cushion will withstand the rigors of everyday stress and wear while remaining comfortable and supportive.

### TRUFIT™

The TruFit™ Backrest System encompasses three unique features found in OM's Truly.\* Series:

**BACK HEIGHT ADJUSTMENT** High-end, exoskeleton task chair designs nearly always leave out an important ergonomic feature — an adjustable height backrest. OM's Truly. features a generous 4.25" of travel range.

**ADJUSTABLE LUMBAR** Typical adjustable depth lumbar regions feature highly localized tightening of either an air bladder or a lumbar pad. OM's Truly. features a lumbar region support that comes from the entire polyback progressively flexing; thereby providing a firm, but still comfortable feeling.

**LIVELY "WORKING SUPPORT"** Truly.'s backrest is a single, continuous polymer membrane that continuously flexes, yet offers great working support for your tasking needs.

# Buyer's Guide

Choosing the Right Chair . . .

## Need help selecting the right OM model for your customer?

Remember though, while we hope this guide is helpful and even a little fun to use, choosing the right chair can not be done on the basis of price or the number of features alone. Proper ergonomics, safety and comfort are all additional important considerations that your customer should weigh equally in making their seating purchase decision.

OM has developed this Price-to-Features Matrix to help you get started in the right direction. Use it to pick an OM model family with the price-to-features profile that most closely matches your customer's needs. Then, to further refine their selection, call on our experienced factory reps and customer service team to arrange samples or find additional information. You can also visit our website for product images, news and updated specifications (omseating.com).

### Specialty Seating Starting Points

Task	PA or Patriot or PC or Affirm Series or Truly.*
Temporary Seating	ST or SG Series or OM5 Active, Tibidi®, Plot Twist™
Ultra-Ergonomic	DB Series or OM5 Series* or Truly.*
Hospital	CL Stool Series & DB Series or OM5 Series or Ginny Series
Police & Call Centers	IUHD / IUPD Series or MXIU / MXPD
Conference & Executive	YS or CE2 or OM5 Series* or Affirm Series or Truly.* or Lorien®
Ergonomic Management	PT Series or Paramount Series or OM5 Series* or PC or Truly.*

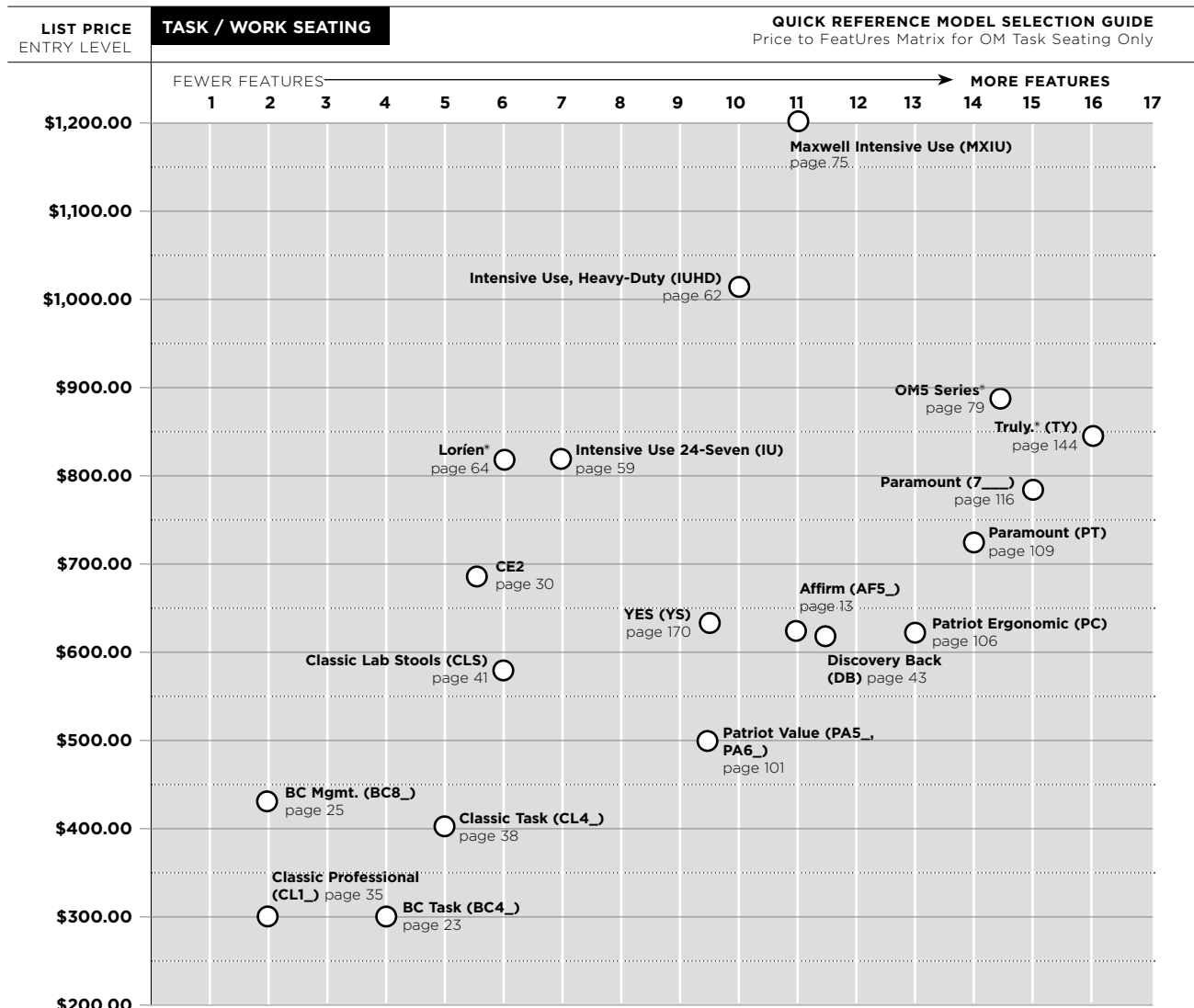



LIST PRICE  
ENTRY LEVEL

**STACK / GUEST / COLLABORATIVE SEATING**

**QUICK REFERENCE MODEL SELECTION GUIDE**  
Price to Features Matrix for OM Task Seating Only

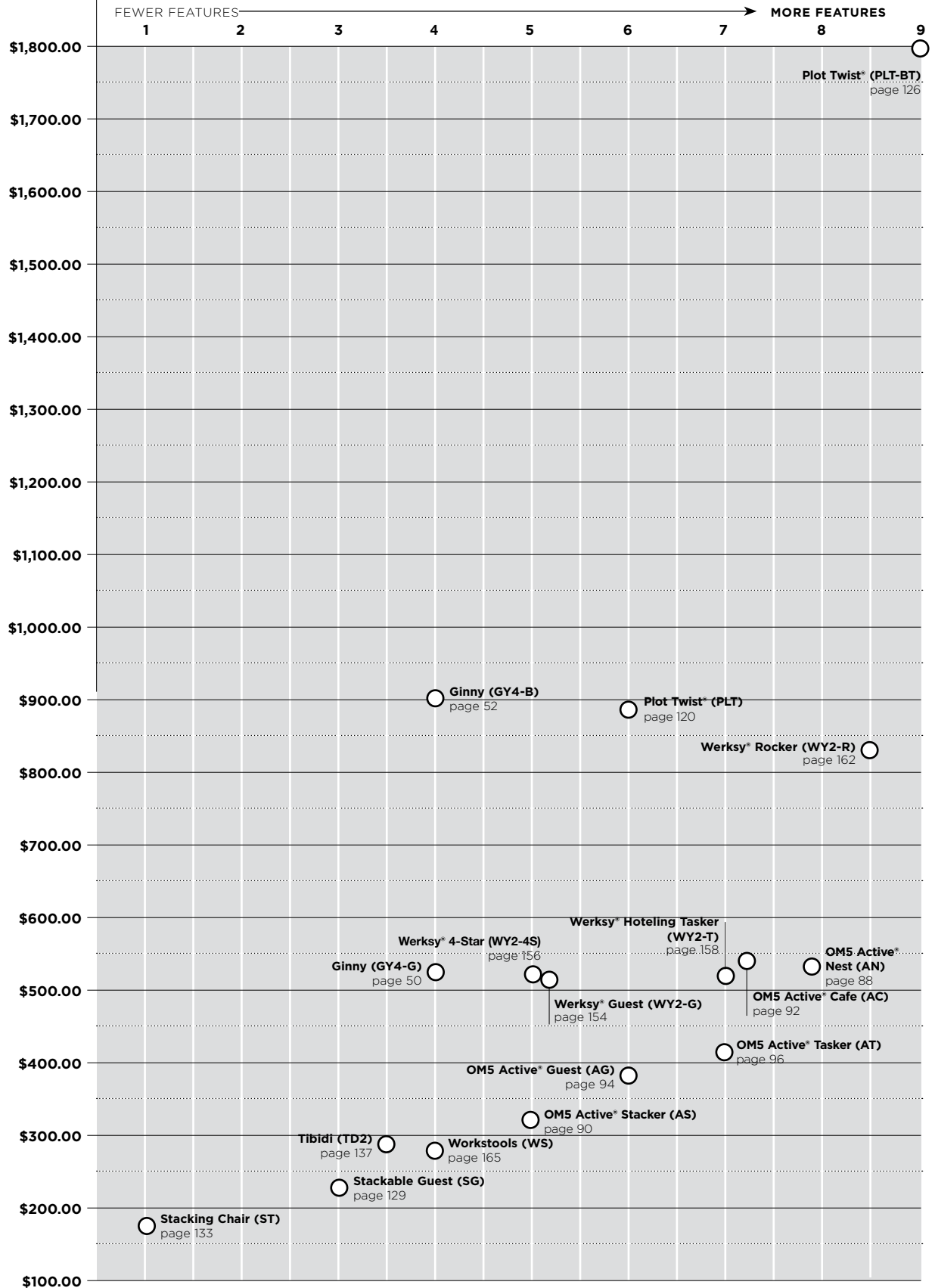

# Clearance

Phased out chairs and options. Limited quantities. Check with OM Seating for availability.

Model	Description	Clearance Pricing	Specifications
BC98S	Available in Black leather only	Black leather	Overall width 26"
	Cantilever sled base	(clearance price)	Overall height 42" (fixed)
 <p><b>Backrest may contain discrete but visible pilot holes in bottom corners.</b></p>	Fixed loop arms standard		Back 20" w x 24" h
			Seat 21" w x 20" d
			Seat height 18" (fixed)
			COM N/A
			Carton weight 67 pounds
			FedEx weight 70 pounds
			Arms Included
			Warranty 7 year limited

Model	Description	Clearance Pricing	Specifications
OM5-XT	Tall back	Click here to specify for pricing	Overall width 28"
	Deep seat		Overall height 40.5" - 45.5"
	Body-activated Motion mechanism		Back 18" w x 24.5" h
	Virtual pause/lock		Seat 19.75" w x 21" d
	Polyback with variable back resistance		Seat height 19" - 24"
			COM 1 yd. seat / 1 yd. back
			Carton weight 69 pounds
			FedEx weight 195 pounds
			Arms Included
			Warranty Lifetime Limited



**AR11 (Fixed Arm)** - clearance price: \$39  
Fixed height and width cantilever arm for Affirm Collection (only).

12-year limited warranty.

**KR100-XM**  
(formerly KR240-XM)



**KR200-XM**



**KR300-XM**



- clearance price: \$99  
Height and width adjustable, removable T-arms with forward-moving extension arm top (RP-XM)  
12-year limited warranty on arm frames and  
5-year limited warranty on arm pads  
1-year limited warranty on specialty arm tops.

# Affirm (AF)

fully cushioned backrest

## Features:

- Fully upholstered and cushioned high-back
- Begins @ \$603 armless / \$722 with KR200 (AF408)
- Flexible options ideal for task, executive, and conference environments
- Contemporary, rectilinear design
- Seat designed with extra waterfall curve and "sit-as-you-like" comfort



# Affirm (AF) fully cushioned backrest

Conference | Boardroom | Executive task

Please see pages 189 -207 for arm kits, casters and options (i.e. over 30 arm rest options for a broad range of users/needs),

high-back

Model	Description	Textile Grade-In	List	Specifications
<b>AF408</b> 	<i>Simple Synchro (-0)</i>	Grade 1 / C.O.M.	\$603.00	Overall width 27"
	Pneumatic lift	Grade 2 / Grade-in A	\$623.00	Overall height 38" - 46.25"
	EZ back height adjustment	Grade 3 / Grade-in B	\$643.00	Back 18.5" w x 21" h
	<b>1-stage locking tilt</b>	Grade 4 / Grade-in C	\$663.00	Seat 19" w x 17.5-20.6" d
	Synchronous seat/back tilt	Grade 5 / Grade-in D	\$683.00	Seat height 17" - 22"
	Cushioned backrest	Grade 6 / Grade-in E	\$703.00	Travel range (ht.) 3" (back) / 5" (seat)
	Seat depth adjustment	LG1 (Evita) / C.O.L.	\$838.00	COM 1 yd.
	Dual-tone universal soft casters	LG2 (Lena- <b>LDEL, LLUT, LORC</b> only)*	\$863.00	Carton / FedEx wt 58 lbs / 101 lbs
	Tension knob	LG3 (Vulcano- <b>LMIT, LSTG</b> only)*	\$888.00	Arms Group AR, 1 & 4

\*For NON In-Stock colors, check with OM Seating for additional pricing details.

Model	Description	Textile Grade-In	List	Specifications
<b>AF418</b> 	<i>Management Synchro (-1)</i>	Grade 1 / C.O.M.	\$670.00	Overall width 27"
	Pneumatic lift	Grade 2 / Grade-in A	\$690.00	Overall height 38" - 46.25"
	EZ back height adjustment	Grade 3 / Grade-in B	\$710.00	Back 18.5" w x 21" h
	<b>3-stage locking tilt</b>	Grade 4 / Grade-in C	\$730.00	Seat 19" w x 17.5-20.6" d
	Synchronous seat/back tilt	Grade 5 / Grade-in D	\$750.00	Seat height 17" - 22"
	Cushioned backrest	Grade 6 / Grade-in E	\$770.00	Travel range (ht.) 3" (back) / 5" (seat)
	Seat depth adjustment	LG1 (Evita) / C.O.L.	\$905.00	COM 1 yd.
	Dual-tone universal soft casters	LG2 (Lena- <b>LDEL, LLUT, LORC</b> only)*	\$930.00	Carton / FedEx wt 58 lbs / 101 lbs
	Tension knob	LG3 (Vulcano- <b>LMIT, LSTG</b> only)*	\$955.00	Arms Group AR, 1 & 4

\*For NON In-Stock colors, check with OM Seating for additional pricing details.

Model	Description	Textile Grade-In	List	Specifications
<b>AF428</b> 	<i>Executive Synchro (-2)</i>	Grade 1 / C.O.M.	\$808.00	Overall width 27"
	Pneumatic lift	Grade 2 / Grade-in A	\$828.00	Overall height 38" - 46.25"
	EZ back height adjustment	Grade 3 / Grade-in B	\$848.00	Back 18.5" w x 21" h
	<b>5-stage locking tilt</b>	Grade 4 / Grade-in C	\$868.00	Seat 19" w x 17.5-20" d
	Synchronous seat/back tilt	Grade 5 / Grade-in D	\$888.00	Seat height 17" - 22"
	Cushioned backrest	Grade 6 / Grade-in E	\$908.00	Travel range (ht.) 3" (back) / 5" (seat)
	Seat depth adjustment	LG1 (Evita) / C.O.L.	\$1,043.00	COM 1 yd.
	Dual-tone universal soft casters	LG2 (Lena- <b>LDEL, LLUT, LORC</b> only)*	\$1,068.00	Carton / FedEx wt 58 lbs / 101 lbs
	<i>Independent back tilt</i>	LG3 (Vulcano- <b>LMIT, LSTG</b> only)*	\$1,093.00	Arms Group AR, 1 & 4
	<i>Side-mounted tension knob</i>			

\*For NON In-Stock colors, check with OM Seating for additional pricing details.

Model	Description	Textile Grade-In	List	Specifications
<b>AF468</b> 	<i>Body-Activated Motion (-6)</i>	Grade 1 / C.O.M.	\$670.00	Overall width 27"
	Pneumatic lift	Grade 2 / Grade-in A	\$690.00	Overall height 38" - 46.25"
	EZ back height adjustment	Grade 3 / Grade-in B	\$710.00	Back 18.5" w x 21" h
	<b>3-stage locking tilt</b>	Grade 4 / Grade-in C	\$730.00	Seat 19" w x 17.5-20.6" d
	Synchronous seat/back tilt	Grade 5 / Grade-in D	\$750.00	Seat height 17" - 22"
	Cushioned backrest	Grade 6 / Grade-in E	\$770.00	Travel range (ht.) 3" (back) / 5" (seat)
	Seat depth adjustment	LG1 (Evita) / C.O.L.	\$905.00	COM 1 yd.
	Dual-tone universal soft casters	LG2 (Lena- <b>LDEL, LLUT, LORC</b> only)*	\$930.00	Carton / FedEx wt 58 lbs / 101 lbs
	<i>Self-weighing seat/back tilt</i>	LG3 (Vulcano- <b>LMIT, LSTG</b> only)*	\$955.00	Arms Group AR, 1 & 4

\*For NON In-Stock colors, check with OM Seating for additional pricing details.

Polished aluminum package default on AF428 only.

Above weights do not include optional arm kits. ; FedEx weight is calculated using FedEx dimensional standards to determine billable weight. ; Pricing and specifications subject to change without notification.

# Affirm (AF) fully cushioned backrest

Conference | Boardroom | Executive task

Please see pages 189 –207 for arm kits, casters and options (i.e. over 30 arm rest options for a broad range of users/needs),

high-back

Model	Description	Textile Grade-In	List	Specifications
 <b>AF478</b>	<i>Simple Multi-Function (-7b)</i>	Grade 1 / C.O.M.	\$640.00	Overall width 27"
	Pneumatic lift	Grade 2 / Grade-in A	\$660.00	Overall height 38" - 46.25"
	EZ back height adjustment	Grade 3 / Grade-in B	\$680.00	Back 18.5" w x 21" h
	Independent seat and back angle adjustment	Grade 4 / Grade-in C	\$700.00	Seat 19" w x 17.5-20.6" d
	Seat depth adjustment	Grade 5 / Grade-in D	\$720.00	Seat height 17" - 22"
	Dual-tone universal soft casters	Grade 6 / Grade-in E	\$740.00	Travel range (ht.) 3" (back) / 5" (seat)
	Cushioned backrest	LG1 (Evita) / C.O.L.	\$875.00	COM 1 yd.
		LG2 (Lena-LDEL, LLUT, LORC only)*	\$900.00	Carton / FedEx wt 58 lbs / 101 lbs
		LG3 (Vulcano-LMIT, LSTG only)*	\$925.00	Arms Group AR, 1 & 4
				Warranty 12 year limited

\*For NON In-Stock colors, check with OM Seating for additional pricing details.

Model	Description	Textile Grade-In	List	Specifications
 <b>AF488</b>	<i>Full Multi-Function (-8b)</i>	Grade 1 / C.O.M.	\$706.00	Overall width 27"
	Pneumatic lift	Grade 2 / Grade-in A	\$726.00	Overall height 38" - 46.25"
	Tilting backrest	Grade 3 / Grade-in B	\$746.00	Back 18.5" w x 21" h
	EZ back height adjustment	Grade 4 / Grade-in C	\$766.00	Seat 19" w x 17.5-20.6" d
	Seat tilting	Grade 5 / Grade-in D	\$786.00	Seat height 17" - 22"
	Seat depth adjustment	Grade 6 / Grade-in E	\$806.00	Travel range (ht.) 3" (back) / 5" (seat)
	Dual-tone universal soft casters	LG1 (Evita) / C.O.L.	\$941.00	COM 1 yd.
	Rocking tilt	LG2 (Lena-LDEL, LLUT, LORC only)*	\$966.00	Carton / FedEx wt 58 lbs / 101 lbs
	Infinite forward tilting	LG3 (Vulcano-LMIT, LSTG only)*	\$991.00	Arms Group AR, 1 & 4
	Cushioned backrest			Warranty 12 year limited

\*For NON In-Stock colors, check with OM Seating for additional pricing details.

stools

Model	Description	Textile Grade-In	List	Specifications
 <b>AF413</b>	<i>Simple Multi-Function (-7aCLS)</i>	Grade 1 / C.O.M.	\$642.00	Overall width 27"
	<i>Grande Spider Package</i>	Grade 2 / Grade-in A	\$662.00	Overall height 47.25" - 58.25"
	Pneumatic lift	Grade 3 / Grade-in B	\$682.00	Back 18.5" w x 21" h
	EZ back height adjustment	Grade 4 / Grade-in C	\$702.00	Seat 19" w x 17.5-20.6" d
	Infinitely locking back tilt	Grade 5 / Grade-in D	\$722.00	Seat height 25" - 33"
	Cushioned backrest	Grade 6 / Grade-in E	\$742.00	Travel range (ht.) 3" (back) / 8" (seat)
	Seat depth adjustment	LG1 (Evita) / C.O.L.	\$877.00	COM 1 yd.
	Dual-tone universal soft casters	LG2 (Lena-LDEL, LLUT, LORC only)*	\$902.00	Carton / FedEx wt 56 lbs / 101 lbs
		LG3 (Vulcano-LMIT, LSTG only)*	\$927.00	Arms Group AR, 1 & 4
				Warranty 12 year limited

\*For NON In-Stock colors, check with OM Seating for additional pricing details.

Model	Description	Textile Grade-In	List	Specifications
 <b>AF415</b>	<i>Simple Multi-Function (-7aCLS)</i>	Grade 1 / C.O.M.	\$762.00	Overall width 27"
	<i>Turn-lock footring</i>	Grade 2 / Grade-in A	\$782.00	Overall height 47.25" - 60.25"
	Pneumatic lift	Grade 3 / Grade-in B	\$802.00	Back 18.5" w x 21" h
	EZ back height adjustment	Grade 4 / Grade-in C	\$822.00	Seat 19" w x 17.5-20.6" d
	Infinitely locking back tilt	Grade 5 / Grade-in D	\$842.00	Seat height 25.5" - 35.5"
	Cushioned backrest	Grade 6 / Grade-in E	\$862.00	Travel range (ht.) 3" (back) / 10" (seat)
	Seat depth adjustment	LG1 (Evita) / C.O.L.	\$997.00	COM 1 yd.
	Carpet casters	LG2 (Lena-LDEL, LLUT, LORC only)*	\$1,022.00	Carton / FedEx wt 58 lbs / 101 lbs
		LG3 (Vulcano-LMIT, LSTG only)*	\$1,047.00	Arms Group AR, 1 & 4
				Warranty 12 year limited

\*For NON In-Stock colors, check with OM Seating for additional pricing details.

Above weights do not include optional arm kits. ; FedEx weight is calculated using FedEx dimensional standards to determine billable weight. ; Pricing and specifications subject to change without notification.

# Affirm (AF) fully cushioned backrest

Conference | Boardroom | Executive task

side and nesting chairs

Model	Description	Textile Grade-In	List	Specifications
AF411S	<i>High back guest</i>	Grade 1 / C.O.M.	\$396.00	Overall width 21.75"
	Cushioned backrest	Grade 2 / Grade-in A	\$416.00	Overall height 38.5" (fixed)
	Cantilever sled base	Grade 3 / Grade-in B	\$436.00	Back 18.5" w x 20.5" h
	Optional arms available	Grade 4 / Grade-in C	\$456.00	Seat 19" w x 16.25" d
		Grade 5 / Grade-in D	\$476.00	Seat height 17.5" (fixed)
		Grade 6 / Grade-in E	\$496.00	COM 1 yd.
		LG1 (Evita) / C.O.L.	\$631.00	Carton weight 56 pounds
		LG2 (Lena-LDEL, LLUT, LORC only)*	\$656.00	FedEx weight 101 pounds
		LG3 (Vulcano-LMIT, LSTG only)*	\$681.00	Arms Group AR, 1 & 4
				Warranty 12 year limited

*\*For NON In-Stock colors, check with OM Seating for additional pricing details.*



300 POUNDS CAPACITY

Model	Description	Textile Grade-In	List	Specifications
AF470N	Flip seat / nesting chair	Grade 1 / C.O.M.	\$468.00	Overall width 24"
	Cushioned backrest	Grade 2 / Grade-in A	\$488.00	Overall height 38.25" (fixed)
	Fixed arm standard	Grade 3 / Grade-in B	\$508.00	Back 18.5" w x 21" h
	Black Powdercoat frame (standard)	Grade 4 / Grade-in C	\$528.00	Seat 18.5" w x 18.5" d
	Silver Powdercoat frame (option)	Grade 5 / Grade-in D	\$548.00	Seat height 18" (fixed)
		Grade 6 / Grade-in E	\$568.00	COM 1 yd.
		LG1 (Evita) / C.O.L.	\$703.00	Carton weight 38 pounds
		LG2 (Lena-LDEL, LLUT, LORC only)*	\$728.00	FedEx weight 85 pounds
		LG3 (Vulcano-LMIT, LSTG only)*	\$753.00	Arms Included
				Warranty 12 year limited

*\*For NON In-Stock colors, check with OM Seating for additional pricing details.*



300 POUNDS CAPACITY



No upcharge on Silver frame option. Add -SLR after model #  
Ships with back detached.

Model	Description	Textile Grade-In	List	Specifications
AF471N	Flip seat / nesting chair	Grade 1 / C.O.M.	\$462.00	Overall width 22.5"
	Cushioned backrest	Grade 2 / Grade-in A	\$482.00	Overall height 38.25" (fixed)
	Armless	Grade 3 / Grade-in B	\$502.00	Back 18.5" w x 21" h
	Black Powdercoat frame (standard)	Grade 4 / Grade-in C	\$522.00	Seat 18.5" w x 18.5" d
	Silver Powdercoat frame (option)	Grade 5 / Grade-in D	\$542.00	Seat height 18" (fixed)
		Grade 6 / Grade-in E	\$562.00	COM 1 yd.
		LG1 (Evita) / C.O.L.	\$697.00	Carton weight 38 pounds
		LG2 (Lena-LDEL, LLUT, LORC only)*	\$722.00	FedEx weight 85 pounds
		LG3 (Vulcano-LMIT, LSTG only)*	\$747.00	Arms none
				Warranty 12 year limited

*\*For NON In-Stock colors, check with OM Seating for additional pricing details.*



300 POUNDS CAPACITY



No upcharge on Silver frame option. Add -SLR after model #  
Ships with back detached.

Above weights do not include optional arm kits. ; FedEx weight is calculated using FedEx dimensional standards to determine billable weight. ; Pricing and specifications subject to change without notification.

# Affirm (AF)

mesh backrest

## Features:

- Begins @ \$627 armless / \$746 with KR200 (AF504)
- Flexible options ideal for task, executive, and conference environments
- Contemporary "frameless", rectilinear design
- Multiple mesh colors (two) and knitted backrest overlay (nine) options
- Seat designed with extra waterfall curve and "sit-as-you-like" comfort



All AF5x4 models now come standard with the SEATAF-S (19" w).

# Affirm (AF) mesh backrest

Conference | Boardroom | Executive task

Please see pages 189 – 207 for arm kits, casters and options (i.e. over 30 arm rest options for a broad range of users/needs),

average / mid back

Model	Description	Textile Grade-In	List	Specifications
<b>AF504</b> 	<i>Simple Synchro (-0)</i>	Grade 1 / C.O.M.	\$627.00	Overall width 27"
	Pneumatic lift	Grade 2 / Grade-in A	\$642.00	Overall height 38.25" - 45.75"
	EZ back height adjustment	Grade 3 / Grade-in B	\$657.00	Back 19.75" w x 20.5" h
	<i>1-stage locking tilt</i>	Grade 4 / Grade-in C	\$672.00	Seat 19" w x 17.5-20.6" d
	Synchronous seat/back tilt	Grade 5 / Grade-in D	\$687.00	Seat height 17" - 22"
	"Frameless" mesh back design	Grade 6 / Grade-in E	\$702.00	Travel range (ht.) 3" (back) / 5" (seat)
	Seat depth adjustment	LG1 (Evita) / C.O.L.	\$762.00	COM 1 yd.
	Dual-tone universal soft casters	LG2 (Lena-LDEL, LLUT, LORC only)*	\$777.00	Carton / FedEx wt 57 lbs / 101 lbs
	Nightfall black mesh is default	LG3 (Vulcano-LMIT, LSTG only)*	\$782.00	Arms Group AR, 1 & 4
	Tension knob			Warranty 12 year limited

\*For NON In-Stock colors, check with OM Seating for additional pricing details.

Model	Description	Textile Grade-In	List	Specifications
<b>AF514</b> 	<i>Management Synchro(-1)</i>	Grade 1 / C.O.M.	\$695.00	Overall width 27"
	Pneumatic lift	Grade 2 / Grade-in A	\$710.00	Overall height 38.25" - 45.75"
	EZ back height adjustment	Grade 3 / Grade-in B	\$725.00	Back 19.75" w x 20.5" h
	<i>3-stage locking tilt</i>	Grade 4 / Grade-in C	\$740.00	Seat 19" w x 17.5-20.6" d
	Synchronous seat/back tilt	Grade 5 / Grade-in D	\$755.00	Seat height 17" - 22"
	"Frameless" mesh back design	Grade 6 / Grade-in E	\$770.00	Travel range (ht.) 3" (back) / 5" (seat)
	Seat depth adjustment	LG1 (Evita) / C.O.L.	\$830.00	COM 1 yd.
	Dual-tone universal soft casters	LG2 (Lena-LDEL, LLUT, LORC only)*	\$845.00	Carton / FedEx wt 57 lbs / 101 lbs
	Nightfall black mesh is default	LG3 (Vulcano-LMIT, LSTG only)*	\$850.00	Arms Group AR, 1 & 4
	Tension knob			Warranty 12 year limited

\*For NON In-Stock colors, check with OM Seating for additional pricing details.

Model	Description	Textile Grade-In	List	Specifications
<b>AF524</b> 	<i>Executive Synchro (-2)</i>	Grade 1 / C.O.M.	\$833.00	Overall width 27"
	Pneumatic lift	Grade 2 / Grade-in A	\$848.00	Overall height 38.25" - 45.75"
	EZ back height adjustment	Grade 3 / Grade-in B	\$863.00	Back 19.75" w x 20.5" h
	<i>5-stage locking tilt</i>	Grade 4 / Grade-in C	\$878.00	Seat 19" w x 17.5-20" d
	Synchronous seat/back tilt	Grade 5 / Grade-in D	\$893.00	Seat height 17" - 22"
	"Frameless" mesh back design	Grade 6 / Grade-in E	\$908.00	Travel range (ht.) 3" (back) / 5" (seat)
	Seat depth adjustment	LG1 (Evita) / C.O.L.	\$968.00	COM 1 yd.
	Dual-tone universal soft casters	LG2 (Lena-LDEL, LLUT, LORC only)*	\$983.00	Carton / FedEx wt 57 lbs / 101 lbs
	<i>Independent back tilt</i>	LG3 (Vulcano-LMIT, LSTG only)*	\$988.00	Arms Group AR, 1 & 4
	<i>Side-mounted tension knob</i>			Warranty 12 year limited

\*For NON In-Stock colors, check with OM Seating for additional pricing details.

Model	Description	Textile Grade-In	List	Specifications
<b>AF564</b> 	<i>Body-Activated Motion (-6)</i>	Grade 1 / C.O.M.	\$695.00	Overall width 27"
	Pneumatic lift	Grade 2 / Grade-in A	\$710.00	Overall height 38.25" - 45.75"
	EZ back height adjustment	Grade 3 / Grade-in B	\$725.00	Back 19.75" w x 20.5" h
	<i>3-stage locking tilt</i>	Grade 4 / Grade-in C	\$740.00	Seat 19" w x 17.5-20.6" d
	Synchronous seat/back tilt	Grade 5 / Grade-in D	\$755.00	Seat height 17" - 22"
	"Frameless" mesh back design	Grade 6 / Grade-in E	\$770.00	Travel range (ht.) 3" (back) / 5" (seat)
	Seat depth adjustment	LG1 (Evita) / C.O.L.	\$830.00	COM 1 yd.
	Dual-tone universal soft casters	LG2 (Lena-LDEL, LLUT, LORC only)*	\$845.00	Carton / FedEx wt 57 lbs / 101 lbs
	Self-weighting seat/back tilt	LG3 (Vulcano-LMIT, LSTG only)*	\$850.00	Arms Group AR, 1 & 4
	Nightfall black mesh is default			Warranty 12 year limited

\*For NON In-Stock colors, check with OM Seating for additional pricing details.

Polished aluminum package default on AF528 & AF529 only. Neighborhood back upholstery optional.

Above weights do not include optional arm kits ; FedEx weight is calculated using FedEx dimensional standards to determine billable weight. ; Pricing and specifications subject to change without notification.



All AF5x4 models now come standard with the SEATAF-S (19" w).

## Affirm (AF) mesh backrest

Please see pages 189 – 207 for arm kits, casters and options (i.e. over 30 arm rest options for a broad range of users/needs),

Conference | Boardroom | Executive task

average / mid back

### Model

## AF574



300 POUNDS CAPACITY

### Description

*Simple Multi-Function (-7b)*

Pneumatic lift  
EZ back height adjustment  
Independent seat and back angle adjustment  
"Frameless" mesh back design  
Seat depth adjustment  
Dual-tone universal soft casters  
Nightfall black mesh is default

### Textile Grade-In

Grade 1 / C.O.M. \$721.00  
Grade 2 / Grade-in A \$736.00  
Grade 3 / Grade-in B \$751.00  
Grade 4 / Grade-in C \$766.00  
Grade 5 / Grade-in D \$781.00  
Grade 6 / Grade-in E \$796.00  
LG1 (Evita) / C.O.L. \$856.00  
LG2 (Lena -LDEL, LLUT, LORC only)\* \$871.00  
LG3 (Vulcano-LMIT, LSTG only)\* \$876.00

### List

### Specifications

Overall width 27"  
Overall height 38.25" - 45.75"  
Back 19.75" w x 20.5" h  
Seat 19" w x 17.5-20.6" d  
Seat height 17" - 22"  
Travel range (ht.) 3" (back) / 5" (seat)  
COM 1 yd.  
Carton / FedEx wt 57 lbs / 101 lbs  
Arms Group AR, 1 & 4  
Warranty 12 year limited

\*For NON In-Stock colors, check with OM Seating for additional pricing details.

### Model

## AF584



300 POUNDS CAPACITY

### Description

*Full Multi-Function (-8b)*

Pneumatic lift  
Tilting backrest  
EZ back height adjustment  
Seat tilting  
"Frameless" mesh back design  
Seat depth adjustment  
Dual-tone universal soft casters  
Rocking tilt  
Infinite forward tilting  
Nightfall black mesh is default  
Tension knob

### Textile Grade-In

Grade 1 / C.O.M. \$773.00  
Grade 2 / Grade-in A \$788.00  
Grade 3 / Grade-in B \$803.00  
Grade 4 / Grade-in C \$818.00  
Grade 5 / Grade-in D \$833.00  
Grade 6 / Grade-in E \$848.00  
LG1 (Evita) / C.O.L. \$908.00  
LG2 (Lena -LDEL, LLUT, LORC only)\* \$923.00  
LG3 (Vulcano-LMIT, LSTG only)\* \$928.00

### List

### Specifications

Overall width 27"  
Overall height 38.25" - 45.75"  
Back 19.75" w x 20.5" h  
Seat 19" w x 17.5-20.6" d  
Seat height 17" - 22"  
Travel range (ht.) 3" (back) / 5" (seat)  
COM 1 yd.  
Carton / FedEx wt 57 lbs / 101 lbs  
Arms Group AR, 1 & 4  
Warranty 12 year limited

\*For NON In-Stock colors, check with OM Seating for additional pricing details.

Neighborhood back upholstery optional.

Above weights do not include optional arm kits. ; FedEx weight is calculated using FedEx dimensional standards to determine billable weight. ; Pricing and specifications subject to change without notification.

# Affirm (AF) mesh backrest

Conference | Boardroom | Executive task

Please see pages 189 – 207 for arm kits, casters and options (i.e. over 30 arm rest options for a broad range of users/needs),

high back

## Model

### AF508



300  
POUNDS  
CAPACITY

## Description

*Simple Synchro (-0)*  
Pneumatic lift  
EZ back height adjustment  
*1-stage locking tilt*  
Synchronous seat/back tilt  
"Frameless" mesh back design  
Seat depth adjustment  
Dual-tone universal soft casters  
Nightfall black mesh is default  
Tension knob

## Textile Grade-In

Grade 1 / C.O.M. \$668.00  
Grade 2 / Grade-in A \$683.00  
Grade 3 / Grade-in B \$698.00  
Grade 4 / Grade-in C \$713.00  
Grade 5 / Grade-in D \$728.00  
Grade 6 / Grade-in E \$743.00  
LG1 (Evita) / C.O.L. \$803.00  
LG2 (Lena-LDEL, LLUT, LORC only)\* \$818.00  
LG3 (Vulcano-LMIT, LSTG only)\* \$823.00

## List

## Specifications

Overall width 27"  
Overall height 41.5" - 49"  
Back 21" w x 24" h  
Seat 20.5" w x 17.5-20.6" d  
Seat height 17" - 22"  
Travel range (ht.) 3" (back) / 5" (seat)  
COM 1 yd.  
Carton / FedEx wt 58 lbs / 101 lbs  
Arms Group AR, 1 & 4  
Warranty 12 year limited

\*For NON In-Stock colors, check with OM Seating for additional pricing details.

## Model

### AF518



300  
POUNDS  
CAPACITY

## Description

*Management Synchro (-1)*  
Pneumatic lift  
EZ back height adjustment  
*3-stage locking tilt*  
Synchronous seat/back tilt  
"Frameless" mesh back design  
Seat depth adjustment  
Dual-tone universal soft casters  
Nightfall black mesh is default  
Tension knob

## Textile Grade-In

Grade 1 / C.O.M. \$734.00  
Grade 2 / Grade-in A \$749.00  
Grade 3 / Grade-in B \$764.00  
Grade 4 / Grade-in C \$779.00  
Grade 5 / Grade-in D \$794.00  
Grade 6 / Grade-in E \$809.00  
LG1 (Evita) / C.O.L. \$869.00  
LG2 (Lena-LDEL, LLUT, LORC only)\* \$884.00  
LG3 (Vulcano-LMIT, LSTG only)\* \$889.00

## List

## Specifications

Overall width 27"  
Overall height 41.5" - 49"  
Back 21" w x 24" h  
Seat 20.5" w x 17.5-20.6" d  
Seat height 17" - 22"  
Travel range (ht.) 3" (back) / 5" (seat)  
COM 1 yd.  
Carton / FedEx wt 58 lbs / 101 lbs  
Arms Group AR, 1 & 4  
Warranty 12 year limited

\*For NON In-Stock colors, check with OM Seating for additional pricing details.

## Model

### AF528



300  
POUNDS  
CAPACITY

## Description

*Executive Synchro (-2)*  
Pneumatic lift  
EZ back height adjustment  
*5-stage locking tilt*  
Synchronous seat/back tilt  
"Frameless" mesh back design  
Seat depth adjustment  
Dual-tone universal soft casters  
*Independent back tilt*  
*Side-mounted tension knob*  
Nightfall black mesh is default

## Textile Grade-In

Grade 1 / C.O.M. \$877.00  
Grade 2 / Grade-in A \$892.00  
Grade 3 / Grade-in B \$907.00  
Grade 4 / Grade-in C \$922.00  
Grade 5 / Grade-in D \$937.00  
Grade 6 / Grade-in E \$952.00  
LG1 (Evita) / C.O.L. \$1,012.00  
LG2 (Lena-LDEL, LLUT, LORC only)\* \$1,027.00  
LG3 (Vulcano-LMIT, LSTG only)\* \$1,032.00

## List

## Specifications

Overall width 27"  
Overall height 41.5" - 49"  
Back 21" w x 24" h  
Seat 20.5" w x 17.5-20" d  
Seat height 17" - 22"  
Travel range (ht.) 3" (back) / 5" (seat)  
COM 1 yd.  
Carton / FedEx wt 58 lbs / 101 lbs  
Arms Group AR, 1 & 4  
Warranty 12 year limited

\*For NON In-Stock colors, check with OM Seating for additional pricing details.

## Model

### AF568



300  
POUNDS  
CAPACITY

## Description

*Body-Activated Motion (-6)*  
Pneumatic lift  
EZ back height adjustment  
*3-stage locking tilt*  
Synchronous seat/back tilt  
"Frameless" mesh back design  
Seat depth adjustment  
Dual-tone universal soft casters  
*Self-weighing seat/back tilt*  
Nightfall black mesh is default

## Textile Grade-In

Grade 1 / C.O.M. \$736.00  
Grade 2 / Grade-in A \$751.00  
Grade 3 / Grade-in B \$766.00  
Grade 4 / Grade-in C \$781.00  
Grade 5 / Grade-in D \$796.00  
Grade 6 / Grade-in E \$811.00  
LG1 (Evita) / C.O.L. \$871.00  
LG2 (Lena-LDEL, LLUT, LORC only)\* \$886.00  
LG3 (Vulcano-LMIT, LSTG only)\* \$891.00

## List

## Specifications

Overall width 27"  
Overall height 41.5" - 49"  
Back 21" w x 24" h  
Seat 20.5" w x 17.5-20.6" d  
Seat height 17" - 22"  
Travel range (ht.) 3" (back) / 5" (seat)  
COM 1 yd.  
Carton / FedEx wt 58 lbs / 101 lbs  
Arms Group AR, 1 & 4  
Warranty 12 year limited

\*For NON In-Stock colors, check with OM Seating for additional pricing details.

Polished aluminum package default on AF528 & AF529 only. Neighborhood back upholstery optional.

Above weights do not include optional arm kits. ; FedEx weight is calculated using FedEx dimensional standards to determine billable weight. ; Pricing and specifications subject to change without notification.

# Affirm (AF) mesh backrest

Conference | Boardroom | Executive task

Please see pages 189 – 207 for arm kits, casters and options (i.e. over 30 arm rest options for a broad range of users/needs),

high back

## Model

### AF578



300  
POUNDS  
CAPACITY

## Description

*Simple Multi-Function (-7b)*

Pneumatic lift  
EZ back height adjustment  
Independent seat and back angle adjustment  
Seat depth adjustment  
Dual-tone universal soft casters  
Nightfall black mesh is default

## Textile Grade-In

Grade 1 / C.O.M. \$762.00  
Grade 2 / Grade-in A \$777.00  
Grade 3 / Grade-in B \$792.00  
Grade 4 / Grade-in C \$807.00  
Grade 5 / Grade-in D \$822.00  
Grade 6 / Grade-in E \$837.00  
LG1 (Evita) / C.O.L. \$897.00  
LG2 (Lena-LDEL, LLUT, LORC only)\* \$912.00  
LG3 (Vulcano-LMIT, LSTG only)\* \$917.00

\*For NON In-Stock colors, check with OM Seating for additional pricing details.

## List

## Specifications

Overall width 27"  
Overall height 41.5" - 49"  
Back 21" w x 24" h  
Seat 20.5" w x 17.5-20.6" d  
Seat height 17" - 22"  
Travel range (ht.) 3" (back) / 5" (seat)  
COM 1 yd.  
Carton / FedEx wt 58 lbs / 101 lbs  
Arms Group AR, 1 & 4  
Warranty 12 year limited

## Model

### AF588



300  
POUNDS  
CAPACITY

## Description

*Full Multi-Function (-8b)*

Pneumatic lift  
Tilting backrest  
EZ back height adjustment  
Seat tilting  
Seat depth adjustment  
Dual-tone universal soft casters  
Rocking tilt  
Infinite forward tilting  
Nightfall black mesh is default  
Tension knob

## Textile Grade-In

Grade 1 / C.O.M. \$814.00  
Grade 2 / Grade-in A \$829.00  
Grade 3 / Grade-in B \$844.00  
Grade 4 / Grade-in C \$859.00  
Grade 5 / Grade-in D \$874.00  
Grade 6 / Grade-in E \$889.00  
LG1 (Evita) / C.O.L. \$949.00  
LG2 (Lena-LDEL, LLUT, LORC only)\* \$964.00  
LG3 (Vulcano-LMIT, LSTG only)\* \$969.00

\*For NON In-Stock colors, check with OM Seating for additional pricing details.

## List

## Specifications

Overall width 27"  
Overall height 41.5" - 49"  
Back 21" w x 24" h  
Seat 20.5" w x 17.5-20.6" d  
Seat height 17" - 22"  
Travel range (ht.) 3" (back) / 5" (seat)  
COM 1 yd.  
Carton / FedEx wt 58 lbs / 101 lbs  
Arms Group AR, 1 & 4  
Warranty 12 year limited

Neighborhood back upholstery optional.

Above weights do not include optional arm kits. ; FedEx weight is calculated using FedEx dimensional standards to determine billable weight. ; Pricing and specifications subject to change without notification.

# Affirm (AF) mesh backrest

Conference | Boardroom | Executive task

Please see pages 189 – 207 for arm kits, casters and options (i.e. over 30 arm rest options for a broad range of users/needs),

high back with headrest

## Model

### AF509



300  
POUNDS  
CAPACITY

## Description

*Simple Synchro (-0)*  
Mesh headrest\*\*  
Pneumatic lift  
EZ back height adjustment  
*1-stage locking tilt*  
Synchronous seat/back tilt  
"Frameless" mesh back design  
Seat depth adjustment  
Dual-tone universal soft casters  
Nightfall black mesh is default  
Tension knob

## Textile Grade-In

Grade 1 / C.O.M. \$746.00  
Grade 2 / Grade-in A \$761.00  
Grade 3 / Grade-in B \$776.00  
Grade 4 / Grade-in C \$791.00  
Grade 5 / Grade-in D \$806.00  
Grade 6 / Grade-in E \$821.00  
LG1 (Evita) / C.O.L. \$881.00  
LG2 (Lena-LDEL, LLUT, LORC only)\* \$896.00  
LG3 (Vulcano-LMIT, LSTG only)\* \$901.00

## List

## Specifications

Overall width 27"  
Overall height 47" - 58"  
Back 21" w x 24" h  
Seat 20.5" w x 17.5-20.6" d  
Seat height 17" - 22"  
Travel range (ht.) 3" (back) / 5" (seat)  
COM 1 yd.  
Carton / FedEx wt 59 lbs / 101 lbs  
Arms Group AR, 1 & 4  
Warranty 12 year limited

\*For NON In-Stock colors, check with OM Seating for additional pricing details.

## Model

### AF519



300  
POUNDS  
CAPACITY

## Description

*Management Synchro (-1)*  
Mesh headrest\*\*  
Pneumatic lift  
EZ back height adjustment  
*3-stage locking tilt*  
Synchronous seat/back tilt  
"Frameless" mesh back design  
Seat depth adjustment  
Dual-tone universal soft casters  
Nightfall black mesh is default  
Tension knob

## Textile Grade-In

Grade 1 / C.O.M. \$812.00  
Grade 2 / Grade-in A \$827.00  
Grade 3 / Grade-in B \$842.00  
Grade 4 / Grade-in C \$857.00  
Grade 5 / Grade-in D \$872.00  
Grade 6 / Grade-in E \$887.00  
LG1 (Evita) / C.O.L. \$947.00  
LG2 (Lena-LDEL, LLUT, LORC only)\* \$962.00  
LG3 (Vulcano-LMIT, LSTG only)\* \$967.00

## List

## Specifications

Overall width 27"  
Overall height 47" - 58"  
Back 21" w x 24" h  
Seat 20.5" w x 17.5-20.6" d  
Seat height 17" - 22"  
Travel range (ht.) 3" (back) / 5" (seat)  
COM 1 yd.  
Carton / FedEx wt 59 lbs / 101 lbs  
Arms Group AR, 1 & 4  
Warranty 12 year limited

\*For NON In-Stock colors, check with OM Seating for additional pricing details.

## Model

### AF529



300  
POUNDS  
CAPACITY

## Description

*Executive Synchro (-2)*  
Mesh headrest\*\*  
Pneumatic lift  
EZ back height adjustment  
*5-stage locking tilt*  
Synchronous seat/back tilt  
"Frameless" mesh back design  
Seat depth adjustment  
Dual-tone universal soft casters  
*Independent back tilt*  
*Side-mounted tension knob*  
Nightfall black mesh is default

## Textile Grade-In

Grade 1 / C.O.M. \$955.00  
Grade 2 / Grade-in A \$970.00  
Grade 3 / Grade-in B \$985.00  
Grade 4 / Grade-in C \$1,000.00  
Grade 5 / Grade-in D \$1,015.00  
Grade 6 / Grade-in E \$1,030.00  
LG1 (Evita) / C.O.L. \$1,090.00  
LG2 (Lena-LDEL, LLUT, LORC only)\* \$1,105.00  
LG3 (Vulcano-LMIT, LSTG only)\* \$1,110.00

## List

## Specifications

Overall width 27"  
Overall height 47" - 58"  
Back 21" w x 24" h  
Seat 20.5" w x 17.5-20" d  
Seat height 17" - 22"  
Travel range (ht.) 3" (back) / 5" (seat)  
COM 1 yd.  
Carton / FedEx wt 59 lbs / 101 lbs  
Arms Group AR, 1 & 4  
Warranty 12 year limited

\*For NON In-Stock colors, check with OM Seating for additional pricing details.

## Model

### AF569



300  
POUNDS  
CAPACITY

## Description

*Body-Activated Motion (-6)*  
Mesh headrest\*\*  
Pneumatic lift  
EZ back height adjustment  
*3-stage locking tilt*  
Synchronous seat/back tilt  
"Frameless" mesh back design  
Seat depth adjustment  
Dual-tone universal soft casters  
Self-weighing seat/back tilt  
Nightfall black mesh is default

## Textile Grade-In

Grade 1 / C.O.M. \$814.00  
Grade 2 / Grade-in A \$829.00  
Grade 3 / Grade-in B \$844.00  
Grade 4 / Grade-in C \$859.00  
Grade 5 / Grade-in D \$874.00  
Grade 6 / Grade-in E \$889.00  
LG1 (Evita) / C.O.L. \$949.00  
LG2 (Lena-LDEL, LLUT, LORC only)\* \$964.00  
LG3 (Vulcano-LMIT, LSTG only)\* \$969.00

## List

## Specifications

Overall width 27"  
Overall height 47" - 58"  
Back 21" w x 24" h  
Seat 20.5" w x 17.5-20.6" d  
Seat height 17" - 22"  
Travel range (ht.) 3" (back) / 5" (seat)  
COM 1 yd.  
Carton / FedEx wt 59 lbs / 101 lbs  
Arms Group AR, 1 & 4  
Warranty 12 year limited

\*For NON In-Stock colors, check with OM Seating for additional pricing details.

\*\* Default headrest for Affirm models is all mesh. For more headrest options, refer to Affirm's Common Options page 22.

Polished aluminum package default on AF528 & AF529 only. Neighborhood back upholstery optional.

Above weights do not include optional arm kits. ; FedEx weight is calculated using FedEx dimensional standards to determine billable weight. ; Pricing and specifications subject to change without notification.

# Affirm (AF) mesh backrest

Conference | Boardroom | Executive task

Please see pages 189 – 207 for arm kits, casters and options (i.e. over 30 arm rest options for a broad range of users/needs),

high back with headrest

Model	Description	Textile Grade-In	List	Specifications
<b>AF579</b> 	<i>Simple Multi-Function (-7b)</i>	Grade 1 / C.O.M.	\$840.00	Overall width 27"
	Mesh headrest**	Grade 2 / Grade-in A	\$855.00	Overall height 47" - 58"
	Pneumatic lift	Grade 3 / Grade-in B	\$870.00	Back 21" w x 24" h
	EZ back height adjustment	Grade 4 / Grade-in C	\$885.00	Seat 20.5" w x 17.5-20.6" d
	Independent seat and back angle adjustment	Grade 5 / Grade-in D	\$900.00	Seat height 17" - 22"
	Seat depth adjustment	Grade 6 / Grade-in E	\$915.00	Travel range (ht.) 3" (back) / 5" (seat)
	Dual-tone universal soft casters	LG1 (Evita) / C.O.L.	\$975.00	COM 1 yd.
	Nightfall black mesh is default	LG2 (Lena-LDEL, LLUT, LORC only)*	\$990.00	Carton / FedEx wt 59 lbs / 101 lbs
		LG3 (Vulcano-LMIT, LSTG only)*	\$995.00	Arms Group AR, 1 & 4
				Warranty 12 year limited

\*For NON In-Stock colors, check with OM Seating for additional pricing details.

Model	Description	Textile Grade-In	List	Specifications
<b>AF589</b> 	<i>Full Multi-function (-8b)</i>	Grade 1 / C.O.M.	\$892.00	Overall width 27"
	Mesh headrest**	Grade 2 / Grade-in A	\$907.00	Overall height 47" - 58"
	Pneumatic lift	Grade 3 / Grade-in B	\$922.00	Back 21" w x 24" h
	Tilting backrest	Grade 4 / Grade-in C	\$937.00	Seat 20.5" w x 17.5-20.6" d
	EZ back height adjustment	Grade 5 / Grade-in D	\$952.00	Seat height 17" - 22"
	Seat tilting	Grade 6 / Grade-in E	\$967.00	Travel range (ht.) 3" (back) / 5" (seat)
	Seat depth adjustment	LG1 (Evita) / C.O.L.	\$1,027.00	COM 1 yd.
	Dual-tone universal soft casters	LG2 (Lena-LDEL, LLUT, LORC only)*	\$1,042.00	Carton / FedEx wt 59 lbs / 101 lbs
	Rocking tilt	LG3 (Vulcano-LMIT, LSTG only)*	\$1,047.00	Arms Group AR, 1 & 4
	Infinite forward tilting			Warranty 12 year limited

\*For NON In-Stock colors, check with OM Seating for additional pricing details.

large / xtra tall

Option	Description	Textile Grade-In	List	Specifications
<b>AFYM</b> 	<i>Simple Multi-Function (-7HD)</i>	Grade 1 / C.O.M.	\$1,327.00	Overall width 28"
	Pneumatic lift	Grade 2 / Grade-in A	\$1,342.00	Overall height 44" - 53"
	EZ back height adjustment	Grade 3 / Grade-in B	\$1,357.00	Back 21" w x 24" h
	Tilting backrest	Grade 4 / Grade-in C	\$1,372.00	Seat 23.5" w x 20.5-23.6" d
	Rocking tilt	Grade 5 / Grade-in D	\$1,387.00	Seat height 19" - 25"
	Forward tilting	Grade 6 / Grade-in E	\$1,402.00	Travel range (ht.) 3" (back) / 6" (seat)
	Tension knob	LG1 (Evita) / C.O.L.	\$1,487.00	COM 1 yd.
	Seat depth adjustment	LG2 (Lena-LDEL, LLUT, LORC only)*	\$1,502.00	Carton / FedEx wt 61 lbs / 195 lbs
	Infinite forward tilting	LG3 (Vulcano-LMIT, LSTG only)*	\$1,512.00	Arms Group 1 & 4
	Nightfall black mesh is default			Warranty 12 year limited

\*For NON In-Stock colors, check with OM Seating for additional pricing details.

option

Model -LX	Description	Textile Grade-In	List
	Luxury stitched mesh back overlay option (-LX)	Grade 3 / Cinema / Illusion	+ \$75.00
	Executive option for Affirm high back & headrest models only	LG1 (Evita) / C.O.L.	+ \$160.00
	Available in leather or OM in-stock (G3 leather-like material)	LG2 (Lena-LDEL, LLUT, LORC only)*	+ \$175.00
		LG3 (Vulcano-LMIT, LSTG only)*	+ \$190.00

\*For NON In-Stock colors, check with OM Seating for additional pricing details.

\*\* Default mesh headrest. For more headrest options, refer to Affirm's Common Options page 22.  
 Polished aluminum package default on AF528 & AF529 only. Neighborhood back upholstery optional.

Above weights do not include optional arm kits. ; FedEx weight is calculated using FedEx dimensional standards to determine billable weight. ; Pricing and specifications subject to change without notification.

# Affirm (AF) mesh backrest

Conference | Boardroom | Executive task

Please see pages 189 – 207 for arm kits, casters and options (i.e. over 30 arm rest options for a broad range of users/needs),

stools

Model	Description	Stool	Textile Grade-In	List	Specifications
 <p>AF513</p>	<i>Simple Multi-Function (-7aCLS)</i>		Grade 1 / C.O.M.	\$735.00	Overall width 27"
	<i>Grande Spider Package</i>		Grade 2 / Grade-in A	\$750.00	Overall height 46" - 57"
	Pneumatic lift		Grade 3 / Grade-in B	\$765.00	Back 19.75" w x 20.5" h
	EZ back height adjustment		Grade 4 / Grade-in C	\$780.00	Seat 19" w x 17.5-20.6" d
	Infinitely locking back tilt		Grade 5 / Grade-in D	\$795.00	Seat height 25" - 33"
	"Frameless" mesh back design		Grade 6 / Grade-in E	\$810.00	Travel range (ht.) 3" (back) / 8" (seat)
	Seat depth adjustment		LG1 (Evita) / C.O.L.	\$870.00	COM 1 yd.
	Dual-tone universal soft casters		LG2 (Lena-LDEL, LLUT, LORC only)*	\$885.00	Carton / FedEx wt 56 lbs / 101 lbs
	Nightfall black mesh is default		LG3 (Vulcano-LMIT, LSTG only)*	\$890.00	Arms Group AR, 1 & 4
					Warranty 12 year limited

\*For NON In-Stock colors, check with OM Seating for additional pricing details.

Model	Description	Stool	Textile Grade-In	List	Specifications
 <p>AF515</p>	<i>Simple Multi-Function (-7aCLS)</i>		Grade 1 / C.O.M.	\$854.00	Overall width 27"
	<i>Turn-lock footing</i>		Grade 2 / Grade-in A	\$869.00	Overall height 46" - 59"
	Pneumatic lift		Grade 3 / Grade-in B	\$884.00	Back 19.75" w x 20.5" h
	EZ back height adjustment		Grade 4 / Grade-in C	\$899.00	Seat 19" w x 17.5-20.6" d
	Infinitely locking back tilt		Grade 5 / Grade-in D	\$914.00	Seat height 25.5" - 35.5"
	"Frameless" mesh back design		Grade 6 / Grade-in E	\$929.00	Travel range (ht.) 3" (back) / 10" (seat)
	Seat depth adjustment		LG1 (Evita) / C.O.L.	\$989.00	COM 1 yd.
	Carpet casters		LG2 (Lena-LDEL, LLUT, LORC only)*	\$1,004.00	Carton / FedEx wt 58 lbs / 101 lbs
	Nightfall black mesh is default		LG3 (Vulcano-LMIT, LSTG only)*	\$1,009.00	Arms Group AR, 1 & 4
					Warranty 12 year limited

\*For NON In-Stock colors, check with OM Seating for additional pricing details.

side / nesting chairs

Model	Description	Guest	Textile Grade-In	List	Specifications
 <p>AF511S</p>	<i>Mid-back guest</i>		Grade 1 / C.O.M.	\$418.00	Overall width 24"
	"Frameless" mesh back design		Grade 2 / Grade-in A	\$433.00	Overall height 40" (fixed)
	Cantilever sled base		Grade 3 / Grade-in B	\$448.00	Back 19.75" w x 20.5" h
	Nightfall black mesh is default		Grade 4 / Grade-in C	\$463.00	Seat 19" w x 17.5" d
	Optional arms available		Grade 5 / Grade-in D	\$478.00	Seat height 18" (fixed)
			Grade 6 / Grade-in E	\$493.00	COM 1 yd.
			LG1 (Evita) / C.O.L.	\$553.00	Carton weight 56 pounds
			LG2 (Lena-LDEL, LLUT, LORC only)*	\$568.00	FedEx weight 101 pounds
			LG3 (Vulcano-LMIT, LSTG only)*	\$573.00	Arms Group AR, 1 & 4
					Warranty 12 year limited

\*For NON In-Stock colors, check with OM Seating for additional pricing details.

Model	Description	Guest	Textile Grade-In	List	Specifications
 <p>AF516S</p>	<i>High back guest</i>		Grade 1 / C.O.M.	\$463.00	Overall width 25"
	"Frameless" mesh back design		Grade 2 / Grade-in A	\$478.00	Overall height 42.5" (fixed)
	Cantilever sled base		Grade 3 / Grade-in B	\$493.00	Back 21" w x 24" h
	Nightfall black mesh is default		Grade 4 / Grade-in C	\$508.00	Seat 20.5" w x 18.5" d
	Optional arms available		Grade 5 / Grade-in D	\$523.00	Seat height 18" (fixed)
			Grade 6 / Grade-in E	\$538.00	COM 1 yd.
			LG1 (Evita) / C.O.L.	\$598.00	Carton weight 57 pounds
			LG2 (Lena-LDEL, LLUT, LORC only)*	\$613.00	FedEx weight 101 pounds
			LG3 (Vulcano-LMIT, LSTG only)*	\$618.00	Arms Group AR, 1 & 4
					Warranty 12 year limited

\*For NON In-Stock colors, check with OM Seating for additional pricing details.

Polished aluminum package default on AF528 & AF529 only. Neighborhood back upholstery optional.

Above weights do not include optional arm kits. ; FedEx weight is calculated using FedEx dimensional standards to determine billable weight. ; Pricing and specifications subject to change without notification.

# Affirm (AF) mesh backrest

Conference | Boardroom | Executive task

Please see pages 189 – 207 for arm kits, casters and options (i.e. over 30 arm rest options for a broad range of users/needs),

side / nesting chairs

Model	Description	Textile Grade-In	List	Specifications
AF570N	<i>Mid-back guest</i> "Frameless" mesh back design Fixed arm standard Black Powdercoat frame (standard) Silver Powdercoat frame (option)	Grade 1 / C.O.M.	\$488.00	Overall width 24"
		Grade 2 / Grade-in A	\$503.00	Overall height 37.75" (fixed)
		Grade 3 / Grade-in B	\$518.00	Back 19.75" w x 20.5" h
		Grade 4 / Grade-in C	\$533.00	Seat 18.5" w x 18.5" d
		Grade 5 / Grade-in D	\$548.00	Seat height 18" (fixed)
		Grade 6 / Grade-in E	\$563.00	COM 1 yd.
		LG1 (Evita) / C.O.L.	\$623.00	Carton weight 38 pounds
		LG2 (Lena- <b>LDEL, LLUT, LORC only</b> )*	\$638.00	FedEx weight 85 pounds
		LG3 (Vulcano- <b>LMIT, LSTG only</b> )*	\$643.00	Arms Included
				Warranty 12 year limited



No upcharge on Silver frame option.  
Add -SLR after model #  
Ships with back detached.

300 POUNDS CAPACITY

\*For NON In-Stock colors, check with OM Seating for additional pricing details.

Model	Description	Textile Grade-In	List	Specifications
AF571N	<i>Mid-back guest</i> "Frameless" mesh back design Black Powdercoat frame (standard) Silver Powdercoat frame (option)	Grade 1 / C.O.M.	\$481.00	Overall width 22.5"
		Grade 2 / Grade-in A	\$496.00	Overall height 37.75" (fixed)
		Grade 3 / Grade-in B	\$511.00	Back 19.75" w x 20.5" h
		Grade 4 / Grade-in C	\$526.00	Seat 18.5" w x 18.5" d
		Grade 5 / Grade-in D	\$541.00	Seat height 18" (fixed)
		Grade 6 / Grade-in E	\$556.00	COM 1 yd.
		LG1 (Evita) / C.O.L.	\$616.00	Carton weight 38 pounds
		LG2 (Lena- <b>LDEL, LLUT, LORC only</b> )*	\$631.00	FedEx weight 85 pounds
		LG3 (Vulcano- <b>LMIT, LSTG only</b> )*	\$636.00	Arms none
				Warranty 12 year limited



No upcharge on Silver frame option.  
Add -SLR after model #  
Ships with back detached.

300 POUNDS CAPACITY

\*For NON In-Stock colors, check with OM Seating for additional pricing details.

Above weights do not include optional arm kits. ; FedEx weight is calculated using FedEx dimensional standards to determine billable weight. ; Pricing and specifications subject to change without notification.











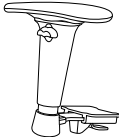
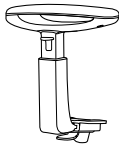
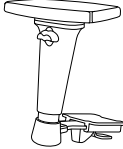

# Affirm (AF) mesh backrest

Conference | Boardroom | Executive task

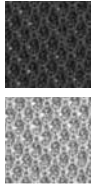
Please see pages 189 – 207 for arm kits, casters and options (i.e. over 30 arm rest options for a broad range of users/needs),

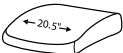
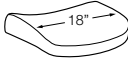
common options

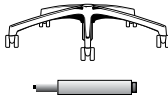
## Common Options for AF Series\*

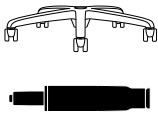
<p><b>Arms</b></p>  <p><b>AR11 (Fixed Arm)</b> - clearance price list: 39.00 Fixed height and width cantilever arm for Affirm Collection (only).</p> <p>12-year limited warranty.</p> <p><b>PHASING OUT</b></p>	 <p><b>AR81 (1D Motion)</b> - list: 205.00 Width adjustable, fixed height polished aluminum loop top arm</p> <p>For specs and warranty, see page 191.</p>
 <p><b>JR39 (2D Motion)</b> - list: 132.00 Height and width adjustable forward slanting T-arms with soft touch width adjustment trigger.</p> <p>For specs. and warranty, see page 193.</p>	 <p><b>AR485 (3D Motion)</b> - list: 349.00 Height and width adjustable polished aluminum loop top arms with pivoting motion.</p> <p>For specs and warranty, see page 194.</p>
 <p><b>JR69 (4D Motion)</b> - list: 196.00 Height and width adjustable, forward slanting T-arms with soft touch width adjustment trigger, lockable arm top, fore-aft, side-side, outward pivoting arm top (RP-65)</p> <p>For specs and warranty, see page 194.</p>	 <p><b>KR100-65 (formerly KR465) (4D Motion)</b> - list: 195.00 Height and width adjustable removable T-arms with lockable arm top, fore-aft, side-side, pivoting arm top (RP-65)</p> <p>For specs and warranty, see page 195.</p>
<p><b>Options</b></p> <p><b>Mesh Color Option</b> - no charge Choose between Nightfall Black (default) or Starlight Silver</p>  	<p><b>“Neighborhood Collection” Backrest Upholstery</b> - list: 88.00 A breathable, knit overlay with 9 lively color choices. Please refer to the OM5 + Affirm Backrest Upholstery card.</p>  <p>Note: Neighborhood Collection fabric is not suitable for seat fabrics</p>
 <p><b>AFS* (formerly SEATAF-S) (small Affirm seat)</b> - list: no upcharge. 19"w, standard on AF511S, AF513, AF515, AF4xy, and AF5x4 models.</p>  <p><b>AFL* (formerly SEATAF-L) (large Affirm seat)</b> - list: no upcharge. 20.5"w, standard on “AF516S, AF5x8, and AF5x9 models.</p> <p>*excludes nesting models</p>	 <p><b>TYP* (formerly SEATTY-P) (petite Truly. seat)</b> list: 30.00 upcharge 18"w x 16.5-19.6"d. Please note seat shape will be different from Affirm style seat.</p> <p>*excludes nesting models</p>
 <p><b>HRD (Deluxe 3D Headrest)</b> - list: 138.00 3-way adjustable headrest with 2 pivot points and an upholstered head/neck-rest pad that slides to accommodate different height users. Available on AF5x9 models only.</p> <p><b>Note:</b> Coat Rack and Headrest combination available with this headrest only. Default in Grade 3 leather-like material</p>	 <p><b>Polished Aluminum Base &amp; 5" Chrome Cylinder Package</b> list: 88.00 (Default on AF528 and AF529)</p>  <p><b>CTR (Coat Rack)</b> - list: 105.00 Black powdercoated, wire rod coat hanger with collar support. Available on high back mesh AF5x8 / AF5x9 models only.</p> <p><b>Note:</b> Coat Rack and Headrest combination available with Deluxe 3D Headrest only.</p>
 <p><b>XSB (formerly XSPKG-B) Petite Black Base Package &amp; 4" HD Cylinder</b> - list: \$55.56 <b>Note:</b> This package changes to 4" cylinder, PT78 base, and Truly. -BUS casters to achieve new lower seat height (15.5" - 19.5"). Cylinder base package will differ from look of standard AF standard base and casters.</p>	 <p><b>XSP (formerly XSPKG-S) Petite Silver Base Package &amp; 4" Cylinder</b> - list: \$85.56 <b>Note:</b> This package changes to 4" cylinder, MX84 base, and Truly. -BUS casters to achieve new lower seat height (15.5" - 19.5"). Cylinder base package will differ from look of standard AF standard base and casters.</p>

\* See pages 189-207 for a complete listing of all available arm, cylinder, caster, and other ergonomic options.

\* Not all options may be applicable to a given model. Check with OM for compatibility details.

\* Arms not available on AF470N, AF471N, AF570N and AF571N.

Above weights do not include optional arm kits. ; FedEx weight is calculated using FedEx dimensional standards to determine billable weight. ; Pricing and specifications subject to change without notification.



# Budget Contract (BC)

## Features:

- Begins @ \$295 armless / \$358 with BR5 (BC42)
  - BC4x - smaller scale “student” and simple task chairs
  - BC8x - well-proportioned “budget management” chairs
  - BC9x - traditional design “budget executive” chairs
- No-nonsense, practical design fits almost any budget
  - Long-lasting & proven contract quality “budget chairs”



# Budget Contract (BC)

Schools | Education

Please see page 28 for relevant arm kit and cylinder options. See pages 204 and 207 for other options.

budget series

Model	Description	Textile Grade-In	List	Specifications
BC42	Pneumatic lift	Grade 1 / C.O.M.	\$295.00	Overall width 25"
	Pivot backrest	Grade 2 / Grade-in A	\$310.00	Overall height 33" - 41"
	Back height adjustment	Grade 3 / Grade-in B	\$325.00	Back 17" w x 15" h
	Back depth adjustment	Grade 4 / Grade-in C	\$340.00	Seat 18" w x 18" d
		Grade 5 / Grade-in D	\$355.00	Seat height 16" - 21"
		Grade 6 / Grade-in E	\$370.00	Travel range (ht.) 3" (back) /5" (seat)
				COM 1 yd.
				Carton / FedEx wt 30 lbs / 36 lbs
				Arms Group BC
				Warranty 7 year limited



Model	Description	Textile Grade-In	List	Specifications
BC44	Pneumatic lift	Grade 1 / C.O.M.	\$354.00	Overall width 25"
	Pivot backrest	Grade 2 / Grade-in A	\$369.00	Overall height 33" - 41"
	Back height adjustment	Grade 3 / Grade-in B	\$384.00	Back 17" w x 15" h
	Tilting backrest	Grade 4 / Grade-in C	\$399.00	Seat 18" w x 18" d
	Tilting seat	Grade 5 / Grade-in D	\$414.00	Seat height 16" - 21"
		Grade 6 / Grade-in E	\$429.00	Travel range (ht.) 3" (back) /5" (seat)
				COM 1 yd.
				Carton / FedEx wt 34 lbs / 36 lbs
				Arms Group BC
				Warranty 7 year limited



Model	Description	Textile Grade-In	List	Specifications
BC46	Pneumatic lift	Grade 1 / C.O.M.	\$338.00	Overall width 25"
	Pivot backrest	Grade 2 / Grade-in A	\$353.00	Overall height 35" - 43"
	Back height adjustment	Grade 3 / Grade-in B	\$368.00	Back 19" w x 17.5" h
	Back depth adjustment	Grade 4 / Grade-in C	\$383.00	Seat 19" w x 19" d
		Grade 5 / Grade-in D	\$398.00	Seat height 16" - 21"
		Grade 6 / Grade-in E	\$413.00	Travel range (ht.) 3" (back) /5" (seat)
				COM 1 yd.
				Carton / FedEx wt 35 lbs / 36 lbs
				Arms Group BC
				Warranty 7 year limited



Model	Description	Textile Grade-In	List	Specifications
BC48	Pneumatic lift	Grade 1 / C.O.M.	\$405.00	Overall width 25"
	Pivot backrest	Grade 2 / Grade-in A	\$420.00	Overall height 35" - 43"
	Back height adjustment	Grade 3 / Grade-in B	\$435.00	Back 19" w x 17.5" h
	Tilting backrest	Grade 4 / Grade-in C	\$450.00	Seat 19" w x 19" d
	Tilting seat	Grade 5 / Grade-in D	\$465.00	Seat height 16" - 21"
		Grade 6 / Grade-in E	\$480.00	Travel range (ht.) 3" (back) /5" (seat)
				COM 1 yd.
				Carton / FedEx wt 40 lbs / 42 lbs
				Arms Group BC
				Warranty 7 year limited



**NOTE:** Most BC chairs ship K.D. For pre-assembly options contact OM for pricing and details.

Above weights do not include optional arm kits. ; FedEx weight is calculated using FedEx dimensional standards to determine billable weight. ; Pricing and specifications subject to change without notification.

Please see page 28 for relevant arm kit and cylinder options. See pages 204 and 207 for other options.

budget management

Model	Description	Textile Grade-In	List	Specifications
BC85	Pneumatic lift	Grade 1 / C.O.M.	\$433.00	Overall width 25"
	Synchronous seat/back tilt	Grade 2 / Grade-in A	\$448.00	Overall height 38" - 43"
	Tilt lock at upright only	Grade 3 / Grade-in B	\$463.00	Back 18.5" w x 19" h
	Tension knob	Grade 4 / Grade-in C	\$478.00	Seat 20" w x 20" d
		Grade 5 / Grade-in D	\$493.00	Seat height 16" - 20"
		Grade 6 / Grade-in E	\$508.00	Travel range (ht.) 4" (seat)
				COM 1 yd.
				Carton / FedEx wt 40 lbs / 68 lbs
				Arms BR-5, BR-85
				Warranty 7 year limited



Model	Description	Textile Grade-In	List	Specifications
BC86	Pneumatic lift	Grade 1 / C.O.M.	\$517.00	Overall width 26"
	Swivel/rocking tilt	Grade 2 / Grade-in A	\$532.00	Overall height 38" - 42"
	Tilt lock at upright only	Grade 3 / Grade-in B	\$547.00	Back 19" w x 22" h
	Tension knob	Grade 4 / Grade-in C	\$562.00	Seat 20" w x 20" d
	Fixed loop arms standard	Grade 5 / Grade-in D	\$577.00	Seat height 16" - 20"
		Grade 6 / Grade-in E	\$592.00	Travel range (ht.) 4" (seat)
				COM 1.5 yds.
				Carton / FedEx wt 48 lbs / 101 lbs
				Arms Included
				Warranty 7 year limited



Model	Description	Textile Grade-In	List	Specifications
BC87	Pneumatic lift	Grade 1 / C.O.M.	\$591.00	Overall width 26"
	Swivel/rocking tilt	Grade 2 / Grade-in A	\$606.00	Overall height 44" - 48"
	Tilt lock at upright only	Grade 3 / Grade-in B	\$621.00	Back 19" w x 26" h
	Tension knob	Grade 4 / Grade-in C	\$636.00	Seat 20" w x 20" d
	Fixed loop arms standard	Grade 5 / Grade-in D	\$651.00	Seat height 16" - 20"
		Grade 6 / Grade-in E	\$666.00	Travel range (ht.) 4" (seat)
				COM 1.5 yds.
				Carton / FedEx wt 54 lbs / 101 lbs
				Arms Included
				Warranty 7 year limited



**NOTE:** Most BC chairs ship K.D. For pre-assembly options contact OM for pricing and details.

Above weights do not include optional arm kits. ; FedEx weight is calculated using FedEx dimensional standards to determine billable weight. ; Pricing and specifications subject to change without notification.

# Budget Contract (BC)

Schools | Education

Please see page 28 for relevant arm kit and cylinder options. See pages 204 and 207 for other options.

budget stools

Model	Description	Textile Grade-In	List	Specifications
BC41	Pneumatic lift	Grade 1 / C.O.M.	\$376.00	Overall width 25"
	Pivot backrest	Grade 2 / Grade-in A	\$391.00	Overall height 40" - 52"
	Back height adjustment	Grade 3 / Grade-in B	\$406.00	Back 17" w x 15" h
	Back depth adjustment	Grade 4 / Grade-in C	\$421.00	Seat 18" w x 18" d
	18" chrome footring	Grade 5 / Grade-in D	\$436.00	Seat height 23" - 33"
			Grade 6 / Grade-in E	\$451.00
				COM 1 yd.
				Carton / FedEx wt 34 lbs / 36 lbs
				Arms Group BC
				Warranty 7 year limited



Model	Description	Textile Grade-In	List	Specifications
BC45	Pneumatic lift	Grade 1 / C.O.M.	\$433.00	Overall width 26"
	Pivot backrest	Grade 2 / Grade-in A	\$448.00	Overall height 40" - 52"
	Back height adjustment	Grade 3 / Grade-in B	\$463.00	Back 17" w x 15" h
	Tilting backrest	Grade 4 / Grade-in C	\$478.00	Seat 18" w x 18" d
	Tilting seat	Grade 5 / Grade-in D	\$493.00	Seat height 23" - 33"
	18" chrome footring	Grade 6 / Grade-in E	\$508.00	Travel range (ht.) 3" (back) / 10" (seat)
				COM 1 yd.
				Carton / FedEx wt 38 lbs / 38 lbs
				Arms Group BC
				Warranty 7 year limited



Model	Description	Textile Grade-In	List	Specifications
BC47	Pneumatic lift	Grade 1 / C.O.M.	\$418.00	Overall width 26"
	Pivot backrest	Grade 2 / Grade-in A	\$433.00	Overall height 42" - 55"
	Back height adjustment	Grade 3 / Grade-in B	\$448.00	Back 19" w x 17.5" h
	Back depth adjustment	Grade 4 / Grade-in C	\$463.00	Seat 19" w x 19" d
	20" black nylon footring	Grade 5 / Grade-in D	\$478.00	Seat height 23" - 33"
			Grade 6 / Grade-in E	\$493.00
				COM 1 yd.
				Carton / FedEx wt 39 lbs / 44 lbs
				Arms Group BC
				Warranty 7 year limited



Model	Description	Textile Grade-In	List	Specifications
BC49	Pneumatic lift	Grade 1 / C.O.M.	\$484.00	Overall width 26"
	Pivot backrest	Grade 2 / Grade-in A	\$499.00	Overall height 42" - 55"
	Back height adjustment	Grade 3 / Grade-in B	\$514.00	Back 19" w x 17.5" h
	Tilting seat	Grade 4 / Grade-in C	\$529.00	Seat 19" w x 19" d
	Tilting back	Grade 5 / Grade-in D	\$544.00	Seat height 23" - 33"
	20" chrome footring	Grade 6 / Grade-in E	\$559.00	Travel range (ht.) 3" (back) / 10" (seat)
				COM 1 yd.
				Carton / FedEx wt 46 lbs / 68 lbs
				Arms Group BC
				Warranty 7 year limited



**NOTE:** Most BC chairs ship K.D. For pre-assembly options contact OM for pricing and details.

Above weights do not include optional arm kits. ; FedEx weight is calculated using FedEx dimensional standards to determine billable weight. ; Pricing and specifications subject to change without notification.

# Budget Contract (BC)

Schools | Education

Please see page 207 for upholstery options to BC48S.

budget side chairs

Model	Description	Textile Grade-In	List	Specifications
BC48S	Cantilever sled base	Grade 1 / C.O.M.	\$290.00	Overall width 20"
		Grade 2 / Grade-in A	\$305.00	Overall height 37" - 39"
		Grade 3 / Grade-in B	\$320.00	Back 19" w x 17.5" h
		Grade 4 / Grade-in C	\$335.00	Seat 19" w x 19" d
		Grade 5 / Grade-in D	\$350.00	Seat height 18" (fixed)
		Grade 6 / Grade-in E	\$365.00	COM 1 yd.
				Carton weight 36 pounds
		FedEx weight 68 pounds		
		Arms Group BC		
		Warranty 7 year limited		



Model	Description	Textile Grade-In	List	Specifications
BC86S	Cantilever sled base Fixed loop arms standard	Grade 1 / C.O.M.	\$405.00	Overall width 25"
		Grade 2 / Grade-in A	\$420.00	Overall height 37.5"(fixed)
		Grade 3 / Grade-in B	\$435.00	Back 19" w x 22" h
		Grade 4 / Grade-in C	\$450.00	Seat 20" w x 20" d
		Grade 5 / Grade-in D	\$465.00	Seat height 18" (fixed)
		Grade 6 / Grade-in E	\$480.00	COM 1.5 yds.
				Carton weight 40 pounds
		FedEx weight 101 pounds		
		Arms Included		
		Warranty 7 year limited		



**NOTE:** Most BC chairs ship K.D. For pre-assembly options contact OM for pricing and details.

Above weights do not include optional arm kits. ; FedEx weight is calculated using FedEx dimensional standards to determine billable weight. ; Pricing and specifications subject to change without notification.









# Budget Contract (BC)

Schools | Education

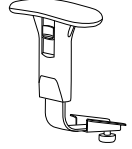
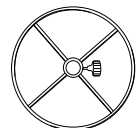
See page 204 for caster options.

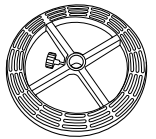
common options

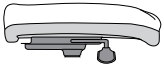
## Common Options for BC Series

<p><b>Arms</b></p> <p><b>BR2</b> - list: 53.00 Width adjustable loop arms Adjustable with range of 2.5" 7 year limited warranty</p> 	<p><b>BR85</b> - list: 47.00 Fixed loop arms Fits BC85 chair 7 year limited warranty</p> 
<p><b>BR5</b> - list: 63.00 Height &amp; width adjustable T-arms Adjustable height range of 4.5" Adjustable width range of 1" 7 year limited warranty 2 year limited warranty on arm pads Note: Version for BC85 is available upon request</p> 	
<p><b>Options</b></p> <p><b>18CR</b> (formerly FTGBC41) - list: 16.00 (upcharge), 59.00 (buy) 18" chrome footring for BC, CL and WS (or exchange with black plastic footring)</p> 	<p><b>4M</b> (formerly CYL-4M) - list: 13.00 (upcharge), 88.00 (buy) 4" cylinder for BC chairs (minimum height lowered by 1", changes range to 4")</p> 
<p><b>20PL</b> (formerly FTG20PL) - list: 16.00 (upcharge), 59.00 (buy) 20" black plastic footring for BC and WS (or exchange with 18" chrome footring)</p> 	<p><b>5M</b> (formerly CYL-5M) - list: 13.00 (upcharge), 73.00 (buy) 5" cylinder for most of BC task and executive chairs</p> 
<p><b>CEZABC</b> - list: 10.00 (upcharge per chair) Basic semi-assembly for BC chairs packaged in carton. (Mechanism and arm brackets pre-attached at factory.)</p> 	<p><b>10M</b> (formerly CYL-10M) - list: N/A (upcharge), 102.00 (buy) 10" cylinder: standard cylinder for BC drafting stools (range of 23-33")</p> 
	<p><b>SEMIBC</b> - list: 25.00 (upcharge per chair) Semi-assembly for BC chairs packaged in carton. (Chair top fully pre-assembled at factory. Tools-free final assembly of cylinder into base and onto casters still required.)</p> 

Pricing and specifications subject to change without notification.

# CE2

## Features:

- Begins @ \$896 with polished reverse cantilever arm (AR82-PLH)
- We kept it simple & the series name says it all about the CE's uses!
- "Body-Activated Motion" responds to user's weight without cumbersome tension knob
- Contemporary pillow-top design with black, full-grain leather seat/back surfaces





# CE2 (CE2-)

Office | Executive | Conference





### CE2 Core Features:

- Simple Styling
- Body Activated Motion
- Multi-surface Casters
- 300 lb. Weight Capacity
- 12 year Limited Warranty

**Note:** Green font color indicates default build for "most popular" configuration of this spread.

1. Model		2. Mechanism		3. Back & Seat	
Code	List	Code	List	Code	List
<b>CE2</b>	<b>+\$697</b>	<b>-6</b> <b>Body Activated Motion</b> • Height adjustable • 3 Position tilt lock	<b>+\$0</b>	<b>-8</b> • <b>Back:</b> 22.5"h x 18.25"w high-back • <b>Seat:</b> 19.25"w x 18"d	<b>+\$0</b>

### OTHER OPTIONS (append to above nomenclature to add to, or override existing options)





Casters and Glides			Headrest	
		List	Code	List
	<b>-GLDR</b> Glides	<b>\$0</b>	<b>-HR</b>	<b>\$129</b>
	<b>-65MS</b> 65mm Grey two-tone multi-surface soft caster	<b>+\$25</b>	Headrest upholstery matches Back & Seat upholstery by default. But for long-term aesthetics and cleanability, OM Seating strongly recommends choosing a dark-colored, coated material whenever possible.	
	<b>-50SS</b> 50mm Safety soft casters, minimizes chair movement when <b>NOT</b> in use	<b>+\$25</b>		
	<b>-50R</b> 50mm Reverse braking caster, restricts chair movement when chair IS in use	<b>+\$35</b>		



## MODEL CODE

Example: **CE2 - 6 - 8 - AR82-PLH - 3P30 - STDP** (new format)

Model #   Mech. Back & seat   Arms   Uph.   Base pkg.

4. Arms (most popular)		
Code		List
	<b>-N</b> (No arms)	<b>+\$0</b>
	<b>-KR23</b> • Fixed width • Height adjustable	<b>+\$65</b>
	<b>-AR82-PLH*</b> <b>Polished Reverse Cantilever Arm</b> • Matching arm pads on coated and leather options	<b>+\$199</b>
	<b>-AR82-BLK (NEW)*</b> <b>Black Powdercoated Reverse Cantilever</b> Available Dec. 2023 • Matching arm pads on coated and leather options.	<b>+\$186</b>
	<b>-AR81</b> <b>Polished Aluminum Loop Top</b> • Fixed width • Width adjustable	<b>+\$205</b>
	<b>-AR485</b> <b>Polished Aluminum Loop Top</b> • Height and width adjustable • Pivoting motion	<b>+\$349</b>

\*Note: If upholstered with Grade 2 Clue or Grade 3 Beau, arm pads will be standard with standard OM black leather (applies to CE2 only).

5. Upholstery	
Currently Approved OM In-Stock Fabrics	
Code	List
<b>2 Week Lead Times:</b>	
• <b>Grade 2 / Clue</b>	<b>-\$30</b>
• <b>Grade 3 / Cinema</b>	<b>\$0</b>
• <b>Grade 3 / Illusion</b>	<b>+\$0</b>
• <b>Grade 3 / Beau</b>	<b>+\$0</b>
• <b>LG1 Evita / C.O.L.</b>	<b>+\$305</b>
• <b>LG2 Lena - LDEL, LLUT, LORC only*</b>	<b>+\$375</b>
• <b>LG3 Vulcano - LMIT, LSTG only*</b>	<b>+\$435</b>

\*For NON In-Stock colors, check with OM Seating for additional pricing details.

Fabric Application Testing is required for non-approved materials. Check with OM Seating for approved materials. [Click here](#) for Fabric Application Testing policy.

6. Base Packages (includes cylinder, base and casters)		
Code		List
<b>Black Base Package Options</b>		
<b>-XSB</b> <b>Low Seat Height Package (Black)</b> (Seat height: 16" - 20") • <b>Cylinder:</b> 4" Black (4BCE) • <b>Base:</b> 28" Black nylon (28NCE) • <b>Casters:</b> 55mm Black two-tone multi-surface (55MSB)		<b>+\$20</b>
<b>-STDB</b> <b>Standard Seat Height Package (Black)</b> (Seat height: 17.5" - 22.5") • <b>Cylinder:</b> 5" Black (5BCE) • <b>Base:</b> 28" Black nylon (28NCE) • <b>Casters:</b> 55mm Black two-tone multi-surface (55MSB)		<b>+\$0</b>
<b>-HIB</b> <b>High Seat Height Package (Black)</b> (Seat height: 19.5" - 24.5") • <b>Cylinder:</b> 5" Black (5BWY) • <b>Base:</b> 28" Black nylon (28NCE) • <b>Casters:</b> 55mm Black two-tone multi-surface (55MSB)		<b>+\$20</b>
<b>Polished Base Package Options</b>		
<b>-XSP</b> <b>Low Seat Height Package (Polished)</b> (Seat height: 16" - 20") • <b>Cylinder:</b> 4" Chrome (4CCE) • <b>Base:</b> 28" Polished aluminum (28PCE) • <b>Casters:</b> 55mm Black two-tone multi-surface (55QMSB)		<b>+\$80</b>
<b>-STDP</b> <b>Standard Seat Height Package (Polished)</b> (Seat height: 17.5" - 22.5") • <b>Cylinder:</b> 5" Chrome (5CCE) • <b>Base:</b> 28" Polished aluminum (28PCE) • <b>Casters:</b> 55mm Black two-tone multi-surface (55QMSB)		<b>+\$80</b>
<b>-HIP</b> <b>High Seat Height Package (Polished)</b> (Seat height: 19.5" - 24.5") • <b>Cylinder:</b> 5" Chrome (5CR) • <b>Base:</b> 28" Polished aluminum (28PCE) • <b>Casters:</b> 55mm Black two-tone multi-surface (55QMSB)		<b>+\$80</b>

\* For even more options, please refer to penultimate page of this price guide.



Dimensions	W	D	H
Overall	27.5"	27.5"	39" - 44"
Seat	19.25"	19"	17.5" - 22.5"
Back	18.25"	N/A	22.5"

Travel Range (height)	N/A	5" seat
<b>Upholstery</b>		
COM	2 yds.*	
<b>Shipping</b>		
	Carton Wt.	FedEx Wt.
	50 lbs.	101 lbs.

\* For pattern repeat larger than 7"V x 7"H check with OM Seating for yardage requirement.



# CE2 (CE2-P)

Office | Executive | Conference





### CE2-PT Core Features:

- Pillow Top Traditional Styling
- Body Activated Motion
- Standard with Lumbar
- Multi-surface Casters
- 300 lb. Weight Capacity
- 12 year Limited Warranty

**Note:** Green font color indicates default build for "most popular" configuration of this spread.

1. Model		2. Mechanism		3. Back & Seat	
Code	List	Code	List	Code	List
<b>CE2-P</b>	<b>\$761</b>	<b>-6</b> <b>Body-Activated Motion</b> • Height adjustable • 3 position tilt lock	<b>\$0</b>	<b>-8</b> • <b>Back:</b> 22.5"h x 18.25"w high-back • <b>Seat:</b> 19.25"w x 18"d	<b>+\$0</b>

### OTHER OPTIONS (append to above nomenclature to add to, or override existing options)

Casters and Glides			Headrest	
		List	Code	List
	<b>-GLDR</b> Glides	<b>\$0</b>	<b>-HRP</b> Headrest upholstery matches Back & Seat upholstery by default. But for long-term aesthetics and cleanability, OM Seating strongly recommends choosing a dark-colored, coated material whenever possible.	<b>\$168</b>
	<b>-65MS</b> 65mm Grey two-tone multi-surface soft caster	<b>+\$25</b>		
	<b>-5OSS</b> 50mm Safety soft casters, minimizes chair movement when <b>NOT</b> in use	<b>+\$25</b>		
	<b>-5OR</b> 50mm Reverse braking caster, restricts chair movement when chair IS in use	<b>+\$35</b>		



**MODEL CODE**

Example: **CE2-P - 6 - 8 - AR82-PLH - BLK - STDP** (new format)

Model #    Mech. Back & seat    Arms    Uph.    Base pkg.

4. Arms (most popular)		
Code		List
	<b>-N</b> (No arms)	<b>+\$0</b>
	<b>-KR23</b> • Fixed width • Height adjustable	<b>+\$65</b>
	<b>-AR82-PLH</b> <i>Polished Reverse Cantilever Arm</i> • Matching arm pads on coated and leather options	<b>+\$199</b>
	<b>-AR82-BLK (NEW)*</b> <i>Black Powdercoated Reverse Cantilever</i> Available Dec. 2023 • Matching arm pads on coated and leather options.	<b>+\$186</b>
	<b>-AR81</b> <i>Polished Aluminum Loop Top</i> • Fixed width • Width adjustable	<b>+\$205</b>
	<b>-AR485</b> <i>Polished Aluminum Loop Top</i> • Height and width adjustable • Pivoting motion	<b>+\$349</b>

\*Note: If upholstered with Grade 2 Clue or Grade 3 Beau, arm pads will be standard with standard OM black leather (applies to CE2-P only).

5. Upholstery	
Currently Approved OM In-Stock Fabrics	
Code	List
<b>Normal Lead Times:</b>	
<b>-BLK</b> Standard top grain black leather. Most similar replacement for discontinued model CE88.	<b>+\$75</b>
<b>-BRN</b> Standard top grain brown leather.	<b>+\$75</b>
<b>2 Week Lead Times:</b>	
• <b>Grade 2 / Clue</b>	<b>-\$40</b>
• <b>Grade 3 / Cinema</b>	<b>+\$0</b>
• <b>Grade 3 / Illusion</b>	<b>+\$0</b>
• <b>Grade 3 / Beau</b>	<b>+\$0</b>
• <b>LG1 Evita / C.O.L.</b>	<b>+\$495</b>
• <b>LG2 Lena - LDEL, LLUT, LORC only*</b>	<b>+\$595</b>
• <b>LG3 Vulcano - LMIT, LSTG only*</b>	<b>+\$695</b>

\*For NON In-Stock colors, check with OM Seating for additional pricing details.

Fabric Application Testing is required for non-approved materials. Check with OM Seating for approved materials. **Click here** for Fabric Application Testing policy.

6. Base Packages (includes cylinder, base and casters)	
Code	List
<b>Black Base Package Options</b>	
<b>-XSB</b> <i>Low Seat Height Package (Black)</i> (Seat height: 16" - 20") • <b>Cylinder:</b> 4" Black (4BCE) • <b>Base:</b> 28" Black nylon (28NCE) • <b>Casters:</b> 55mm Black two-tone multi-surface (55MSB)	<b>+\$20</b>
<b>-STDB</b> <i>Standard Seat Height Package (Black)</i> (Seat height: 17.5" - 22.5") • <b>Cylinder:</b> 5" Black (5BCE) • <b>Base:</b> 28" Black nylon (28NCE) • <b>Casters:</b> 55mm Black two-tone multi-surface (55MSB)	<b>+\$0</b>
<b>-HIB</b> <i>High Seat Height Package (Black)</i> (Seat height: 19.5" - 24.5") • <b>Cylinder:</b> 5" Black (5BWW) • <b>Base:</b> 28" Black nylon (28NCE) • <b>Casters:</b> 55mm Black two-tone multi-surface (55MSB)	<b>+\$20</b>
<b>Polished Base Package Options</b>	
<b>-XSP</b> <i>Low Seat Height Package (Polished)</i> (Seat height: 16" - 20") • <b>Cylinder:</b> 4" Chrome (4CCE) • <b>Base:</b> 28" Polished aluminum (28PCE) • <b>Casters:</b> 55mm Black two-tone multi-surface (55QMSB)	<b>+\$80</b>
<b>-STDP</b> <i>Standard Seat Height Package (Polished)</i> (Seat height: 17.5" - 22.5") • <b>Cylinder:</b> 5" Chrome (5CCE) • <b>Base:</b> 28" Polished aluminum (28PCE) • <b>Casters:</b> 55mm Black two-tone multi-surface (55QMSB)	<b>+\$80</b>
<b>-HIP</b> <i>High Seat Height Package (Polished)</i> (Seat height: 19.5" - 24.5") • <b>Cylinder:</b> 5" Chrome (5CR) • <b>Base:</b> 28" Polished aluminum (28PCE) • <b>Casters:</b> 55mm Black two-tone multi-surface (55QMSB)	<b>+\$80</b>

\* For even more options, please refer to penultimate page of this price guide.



Dimensions	W	D	H
Overall	27.5"	27.5"	39" - 44"
Seat	19.25"	19"	17.5" - 22.5"
Back	18.25"	N/A	22.5"

<b>Travel Range (height)</b>	N/A	5" seat
<b>Upholstery</b>		
COM	3 yds.*	
<b>Shipping</b>		
	<b>Carton Wt.</b>	<b>FedEx Wt.</b>
	50 lbs.	101 lbs.

\* For pattern repeat larger than 7"V x 7"H check with OM Seating for yardage requirement.



# Classic

## Features:

- Begins @ \$297 armless stool (CL12)
- CL1x, -2x, -3x - Thoughtfully designed for doctor's exam rooms
- Casters that move less readily until a user is fully seated
- 360 degree accessible, round exam stool height adjuster
- Foot-activated seat height control for hygienic adjustments
- Priced to keep your patients AND wallets both happy and healthy!
- CL4x - Modestly priced simple task stools and chairs with basic features



# Classic (CL)

Healthcare | Lab

Please see pages 189 – 207 for casters and options.

exam room stools

Model	Description	Textile Grade-In	List	Specifications
CL12	Pneumatic lift	Grade 1 / C.O.M.	\$297.00	Overall width 22"
	Chrome base	Grade 2 / Grade-in A	\$312.00	Overall height 15.5" - 20.5"
	Safety soft casters	Grade 3 / Grade-in B	\$327.00	Back N/A
	Circle ring height adjuster	Grade 4 / Grade-in C	\$342.00	Seat 16" diameter
		Grade 5 / Grade-in D	\$357.00	Seat height 15.5" - 20.5"
		Grade 6 / Grade-in E	\$372.00	Travel range (ht.) 5" (seat)
				COM .75 yd.
				Carton / FedEx wt 23 lbs / 28 lbs
				Arms N/A
				Warranty 12 year limited



**NOTE:** OM reserves the right to ship up to 3x CL stools per carton. A \$20 net fee may apply for split cartoning (i.e., 3 stools in 3 boxes).

Model	Description	Textile Grade-In	List	Specifications
CL13	Pneumatic lift	Grade 1 / C.O.M.	\$416.00	Overall width 22"
	Chrome base	Grade 2 / Grade-in A	\$431.00	Overall height 22" - 32"
	Safety soft casters	Grade 3 / Grade-in B	\$446.00	Back N/A
	Circle ring height adjuster	Grade 4 / Grade-in C	\$461.00	Seat 16" diameter
	18" chrome footring	Grade 5 / Grade-in D	\$476.00	Seat height 22" - 32"
	Optional 8" cylinder available 18.5" - 26.5"	Grade 6 / Grade-in E	\$491.00	Travel range (ht.) 10" (seat)
				COM .75 yd.
				Carton / FedEx wt 23 lbs / 28 lbs
				Arms N/A
				Warranty 12 year limited



**NOTE:** OM reserves the right to ship up to 3x CL stools per carton. A \$20 net fee may apply for split cartoning (i.e., 3 stools in 3 boxes).

Model	Description	Textile Grade-In	List	Specifications
CL14	Pneumatic lift	Grade 1 / C.O.M.	\$583.00	Overall width 22"
	Chrome base	Grade 2 / Grade-in A	\$598.00	Overall height 16" - 21"
	Safety soft casters	Grade 3 / Grade-in B	\$613.00	Back N/A
	Foot activation	Grade 4 / Grade-in C	\$628.00	Seat 16" diameter
		Grade 5 / Grade-in D	\$643.00	Seat height 16" - 21"
		Grade 6 / Grade-in E	\$658.00	Travel range (ht.) 5" (seat)
				COM .75 yd.
				Carton / FedEx wt 25 lbs / 28 lbs
				Arms N/A
				Warranty 12 year limited



**NOTE:** OM reserves the right to ship up to 3x CL stools per carton. A \$20 net fee may apply for split cartoning (i.e., 3 stools in 3 boxes).

Model	Description	Textile Grade-In	List	Specifications
CL15	Pneumatic lift	Grade 1 / C.O.M.	\$699.00	Overall width 25"
	Chrome base	Grade 2 / Grade-in A	\$714.00	Overall height 28" - 36"
	Safety soft casters	Grade 3 / Grade-in B	\$729.00	Back 13" w x 11" h
	Foot activation	Grade 4 / Grade-in C	\$744.00	Seat 16" diameter
	Back height adjustment	Grade 5 / Grade-in D	\$759.00	Seat height 16" - 21"
	Fabric panel back	Grade 6 / Grade-in E	\$774.00	Travel range (ht.) 2.5" (back) / 5" (seat)
Unique back support				COM 1 yd.
				Carton / FedEx wt 30 lbs / 33 lbs
				Arms N/A
				Warranty 12 year limited



**NOTE:** OM reserves the right to ship up to 2x CL stools per carton. A \$20 net fee may apply for split cartoning (i.e., 2 stools in 2 boxes).

Above weights do not include optional arm kits. ; FedEx weight is calculated using FedEx dimensional standards to determine billable weight. ; Pricing and specifications subject to change without notification.

Please see pages 189 – 207 for casters and options.

exam room stools

**Model**

CL22



**Description**

- Pneumatic lift
- Chrome base
- Safety soft casters
- Paddle height adjuster
- Back height adjustment
- Fabric panel back
- Unique back support

**NOTE:** OM reserves the right to ship up to 2x CL stools per carton. A \$20 net fee may apply for split cartoning (i.e., 2 stools in 2 boxes).

**Textile Grade-In**

- Grade 1 / C.O.M. \$450.00
- Grade 2 / Grade-in A \$465.00
- Grade 3 / Grade-in B \$480.00
- Grade 4 / Grade-in C \$495.00
- Grade 5 / Grade-in D \$510.00
- Grade 6 / Grade-in E \$525.00

**List**

**Specifications**

- Overall width 25"
- Overall height 28" - 37"
- Back 13" w x 11" h
- Seat 16" diameter
- Seat height 16" - 21"
- Travel range (ht.) 2.5" (back) / 5" (seat)
- COM 1 yd.
- Carton / FedEx wt 31 lbs / 33 lbs
- Arms N/A
- Warranty 12 year limited

**Model**

CL23



**Description**

- Pneumatic lift
- Chrome base
- Safety soft casters
- Paddle height adjuster
- 18" chrome footring
- Back height adjustment
- Fabric panel back
- Unique back support
- Optional 8" cylinder available 20" - 28"

**Textile Grade-In**

- Grade 1 / C.O.M. \$580.00
- Grade 2 / Grade-in A \$595.00
- Grade 3 / Grade-in B \$610.00
- Grade 4 / Grade-in C \$625.00
- Grade 5 / Grade-in D \$640.00
- Grade 6 / Grade-in E \$655.00

**List**

**Specifications**

**NOTE:** OM reserves the right to ship up to 2x CL stools per carton. A \$20 net fee may apply for split cartoning (i.e., 2 stools in 2 boxes).

- Overall width 25"
- Overall height 35" - 47"
- Back 13" w x 11" h
- Seat 16" diameter
- Seat height 23" - 33"
- Travel range (ht.) 2.5" (back) / 10" (seat)
- COM 1 yd.
- Carton / FedEx wt 31 lbs / 33 lbs
- Arms N/A
- Warranty 12 year limited

**Model**

CL33



**Description**

- Pneumatic lift
- Grande spider base
- Safety soft casters
- Circle ring height adjuster
- 8" chrome cylinder

**Textile Grade-In**

- Grade 1 / C.O.M. \$385.00
- Grade 2 / Grade-in A \$400.00
- Grade 3 / Grade-in B \$415.00
- Grade 4 / Grade-in C \$430.00
- Grade 5 / Grade-in D \$445.00
- Grade 6 / Grade-in E \$460.00

**List**

**Specifications**

- Overall width 27"
- Overall height 25" - 33"
- Back N/A
- Seat 16" diameter
- Seat height 25" - 33"
- Travel range (ht.) 8" (seat)
- COM .75 yd.
- Carton / FedEx wt 26 lbs / 33 lbs
- Arms N/A
- Warranty 12 year limited

**Model**

CL35



**Description**

- Pneumatic lift
- Grande spider base
- Safety soft casters
- Back height adjustment
- Fabric panel back
- Unique back support
- 8" chrome cylinder

**Textile Grade-In**

- Grade 1 / C.O.M. \$465.00
- Grade 2 / Grade-in A \$480.00
- Grade 3 / Grade-in B \$495.00
- Grade 4 / Grade-in C \$510.00
- Grade 5 / Grade-in D \$525.00
- Grade 6 / Grade-in E \$540.00

**List**

**Specifications**

- Overall width 27"
- Overall height 37" - 47"
- Back 13" w x 11" h
- Seat 16" diameter
- Seat height 25" - 33"
- Travel range (ht.) 2.5" (back) / 8" (seat)
- COM 1 yd.
- Carton / FedEx wt 29 lbs / 33 lbs
- Arms N/A
- Warranty 12 year limited

Above weights do not include optional arm kits. ; FedEx weight is calculated using FedEx dimensional standards to determine billable weight. ; Pricing and specifications subject to change without notification.

# Classic (CL)

Healthcare | Lab

Please see pages 39, 189 – 207 for casters and options.

small / petite

Model	Description	Textile Grade-In	List	Specifications
 <b>CL44EZ</b>	Simple Multi-Function (-7bNS)	Grade 1 / C.O.M.	\$453.00	Overall width 25"
	Pneumatic lift	Grade 2 / Grade-in A	\$468.00	Overall height 32" - 41"
	EZ Back height adjustment	Grade 3 / Grade-in B	\$483.00	Back 16" w x 13" h
	Independent seat and back angle adjustment	Grade 4 / Grade-in C	\$498.00	Seat 18" w x 17" d
	Carpet casters	Grade 5 / Grade-in D	\$513.00	Seat height 16" - 21"
		Grade 6 / Grade-in E	\$528.00	Travel range (ht.) 4" (back) / 5" (seat)
		LG1 (Evita) / C.O.L.	\$673.00	COM 1 yd.
		LG2 (Lena- <b>LDEL, LLUT, LORC only</b> )*	\$698.00	Carton / FedEx wt 33 lbs / 68 lbs
		LG3 (Vulcano- <b>LMIT, LSTG only</b> )*	\$728.00	Arms Group 1 & 4
*For NON In-Stock colors, check with OM Seating for additional pricing details.				Warranty 12 year limited

Model	Description	Textile Grade-In	List	Specifications
 <b>CL44MD</b>	Simple Multi-Function (-7aCLSNS)	Grade 1 / C.O.M.	\$407.00	Overall width 25"
	Pneumatic lift	Grade 2 / Grade-in A	\$422.00	Overall height 32" - 41"
	EZ Back height adjustment	Grade 3 / Grade-in B	\$437.00	Back 16" w x 13" h
	Infinitely locking back tilt	Grade 4 / Grade-in C	\$452.00	Seat 18" w x 17" d
	Polished aluminum package	Grade 5 / Grade-in D	\$467.00	Seat height 16" - 21"
	Safety soft casters	Grade 6 / Grade-in E	\$482.00	Travel range (ht.) 3" (back) / 5" (seat)
				COM 1 yd.
				Carton / FedEx wt 34 lbs / 68 lbs
				Arms Group 1 & 4
				Warranty 12 year limited

average / medium

Model	Description	Textile Grade-In	List	Specifications
 <b>CL48EZ</b>	Simple Multi-Function (-7bNS)	Grade 1 / C.O.M.	\$525.00	Overall width 25"
	Pneumatic lift	Grade 2 / Grade-in A	\$540.00	Overall height 37" - 45.5"
	EZ Back height adjustment	Grade 3 / Grade-in B	\$555.00	Back 17" w x 22" h
	Independent seat and back angle adjustment	Grade 4 / Grade-in C	\$570.00	Seat 18.5" w x 17" d
	Carpet casters	Grade 5 / Grade-in D	\$585.00	Seat height 16" - 21"
		Grade 6 / Grade-in E	\$600.00	Travel range (ht.) 4" (back) / 5" (seat)
		LG1 (Evita) / C.O.L.	\$745.00	COM 1 yd.
		LG2 (Lena- <b>LDEL, LLUT, LORC only</b> )*	\$770.00	Carton / FedEx wt 39 lbs / 101 lbs
		LG3 (Vulcano- <b>LMIT, LSTG only</b> )*	\$800.00	Arms Group 1 & 4
*For NON In-Stock colors, check with OM Seating for additional pricing details.				Warranty 12 year limited

Above weights do not include optional arm kits . ; FedEx weight is calculated using FedEx dimensional standards to determine billable weight. ; Pricing and specifications subject to change without notification.



Please see pages 39, 189 – 207 for casters and options.

stools

Model	Description	Textile Grade-In	List	Specifications
 <b>CL45EZ</b>	Simple Multi-Function (-7bNS)	Grade 1 / C.O.M.	\$568.00	Overall width 27"
	Pneumatic lift	Grade 2 / Grade-in A	\$583.00	Overall height 41" - 55"
	EZ Back height adjustment	Grade 3 / Grade-in B	\$598.00	Back 16" w x 13" h
	20" chrome footring	Grade 4 / Grade-in C	\$613.00	Seat 18" w x 17" d
	Independent seat and back angle adjustment	Grade 5 / Grade-in D	\$628.00	Seat height 24" - 34"
	Optional 8" cylinder available (20" - 28")	Grade 6 / Grade-in E	\$643.00	Travel range (ht.) 4" (back) / 10" (seat)
	Carpet casters	LG1 (Evita) / C.O.L.	\$788.00	COM 1 yd.
		LG2 (Lena- <b>LDEL, LLUT, LORC only</b> )*	\$813.00	Carton / FedEx wt 39 lbs / 68 lbs
		LG3 (Vulcano- <b>LMIT, LSTG only</b> )*	\$843.00	Arms Group 1 & 4
				Warranty 12 year limited

\*For NON In-Stock colors, check with OM Seating for additional pricing details.



Model	Description	Textile Grade-In	List	Specifications
 <b>CL47</b>	Simple Multi-Function (-7aCLS)	Grade 1 / C.O.M.	\$655.00	Overall width 27"
	Pneumatic lift	Grade 2 / Grade-in A	\$670.00	Overall height 41" - 54"
	EZ Back height adjustment	Grade 3 / Grade-in B	\$685.00	Back 17" w x 16.5" h
	Infinitely locking back tilt	Grade 4 / Grade-in C	\$700.00	Seat 20" w x 17-20.1" d
	Seat slider	Grade 5 / Grade-in D	\$715.00	Seat height 25.5" - 35.5"
	Turn-lock footring	Grade 6 / Grade-in E	\$730.00	Travel range (ht.) 3" (back) / 10" (seat)
	Optional 8" cylinder available	LG1 (Evita) / C.O.L.	\$875.00	COM 1 yd.
	Carpet casters	LG2 (Lena- <b>LDEL, LLUT, LORC only</b> )*	\$900.00	Carton / FedEx wt 58 lbs / 101 lbs
		LG3 (Vulcano- <b>LMIT, LSTG only</b> )*	\$930.00	Arms Group 1 & 4
				Warranty 12 year limited

\*For NON In-Stock colors, check with OM Seating for additional pricing details.

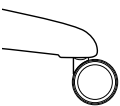
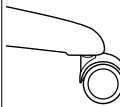
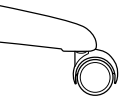
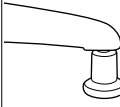
common options

Suggested Options for CL Series	
<b>Casters</b> 	<b>65MS (formerly CAS0065-S)</b> - list: 25.00 (upcharge) Dual-tone Universal Soft Casters Dual-tone; designed for wood, tile and smooth or harder surfaces. For most stools. (5 per set)
	<b>50R (formerly CAS0050-RB)</b> - list: 35.00 (upcharge) Reverse Braking Caster Restricted chair movement when chair IS in use (5 per set)
	<b>50SS (formerly CAS0050-SS)</b> - list: 25.00 (upcharge) Safety Soft Caster Minimizes chair movement when NOT in use (5 per set)
	<b>GLDR (formerly GLD)</b> - (no charge to substitute) Not appropriate for all models. Check with factory for details (5 per set)

Suggested Options for CL Series (CL44EZ, CL44MD, CL45EZ & CL48EZ)

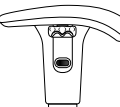
Arms	
	<b>KR100M (2D Motion) (formerly KR-240M)</b> - list: 144.00 Height and width adjustable, removable T-arms with natural grip control and Memosoft arm pads.  For specs and warranty, see page 193.
	<b>KR100-45 (4D Motion) (formerly KR445)</b> - list: 185.00 Height and width adjustable, removable T-arms with fore-aft, side-side, and inward pivoting arm tops (RP-45).  For specs and warranty, see page 194.
	<b>KR200 (2D Motion)</b> - list: 119.00 Height and width adjustable, removable T-arms with natural grip control.  For specs and warranty, see page 193.
	<b>KR25 (1D Motion)</b> - list: 70.00 Fixed width, height adjustable T-arms featuring natural grip control  For specs and warranty, see page 192.

See pages 189-207 for a complete listing of all available arm, cylinder, caster, and other ergonomic options.

Not all options may be applicable to a given model. Check with OM for compatibility details.

Above weights do not include optional arm kits. ; FedEx weight is calculated using FedEx dimensional standards to determine billable weight. ; Pricing and specifications subject to change without notification.



# Classic Lab Stools

(To be renamed "PAC-LS" in 2024)

## Features:

- Begins @ \$559 armless / \$678 with KR200 arms (CLS53)
- "No fuss" & durable lab stools were designed with ease-of-access in mind
- Lab Stool counterparts to the PA53, PA55 and PA57D (i.e., CLS53, CLS61, CLS57D, respectively)
- Fixed height, welded-on, extra-wide footring allows for stable foot support



# Classic Professional (CLS) (CLS | to be renamed "PAC-LS" in 2024)

Healthcare | Lab

Please see pages 189 – 207 for arm kits, casters and other options.

small / petite

Model	Description	Textile Grade-In	List	Specifications
<b>CLS53</b> (aka, PAC53-LS)	Simple Multi-function (-7aCLS)	Grade 1 / C.O.M.	\$559.00	Overall width 27"
	Pneumatic lift	Grade 2 / Grade-in A	\$579.00	Overall height 43" - 54"
	Tilting backrest	Grade 3 / Grade-in B	\$599.00	Back 17" w x 16.5" h
	EZ back height adjustment	Grade 4 / Grade-in C	\$619.00	Seat 19" w x 16.5-19.6" d
	Seat depth adjustment	Grade 5 / Grade-in D	\$639.00	Seat height 25" - 33"
	Grande Spider Package	Grade 6 / Grade-in E	\$659.00	Travel range (ht.) 3" (back) / 8" (seat)
	Dual-tone universal soft casters	LG1 (Evita) / C.O.L.	\$779.00	COM 1 yd.
		LG2 (Lena- <b>LDEL, LLUT, LORC only</b> )*	\$804.00	Carton / FedEx wt 59 lbs / 100 lbs
		LG3 (Vulcano- <b>LMIT, LSTG only</b> )*	\$834.00	Arms Group 1 & 4
				Warranty 12 year limited

\*For NON In-Stock colors, check with OM Seating for additional pricing details.



average / medium

Model	Description	Textile Grade-In	List	Specifications
<b>CLS57D</b> (aka, PAC57-LS)	Simple Multi-function (-7aCLS)	Grade 1 / C.O.M.	\$599.00	Overall width 27"
	Pneumatic lift	Grade 2 / Grade-in A	\$619.00	Overall height 46" - 57"
	Tilting backrest	Grade 3 / Grade-in B	\$639.00	Back 18.5" w x 19.5" h
	EZ back height adjustment	Grade 4 / Grade-in C	\$659.00	Seat 21" w x 18.5-21.6" d
	Seat depth adjustment	Grade 5 / Grade-in D	\$679.00	Seat height 25" - 33"
	Grande Spider Package	Grade 6 / Grade-in E	\$699.00	Travel range (ht.) 3" (back) / 8" (seat)
	Dual-tone universal soft casters	LG1 (Evita) / C.O.L.	\$819.00	COM 1 yd.
		LG2 (Lena- <b>LDEL, LLUT, LORC only</b> )*	\$844.00	Carton / FedEx wt 60 lbs / 100 lbs
		LG3 (Vulcano- <b>LMIT, LSTG only</b> )*	\$874.00	Arms Group 1 & 4
				Warranty 12 year limited

\*For NON In-Stock colors, check with OM Seating for additional pricing details.



Model	Description	Textile Grade-In	List	Specifications
<b>CLS61</b> (aka, PAC55-LS)	Simple Multi-function (-7aCLS)	Grade 1 / C.O.M.	\$623.00	Overall width 27"
	Pneumatic lift	Grade 2 / Grade-in A	\$643.00	Overall height 46" - 57"
	Tilting backrest	Grade 3 / Grade-in B	\$663.00	Back 20" w x 21" h
	EZ back height adjustment	Grade 4 / Grade-in C	\$683.00	Seat 20.5" w x 16-19.1" d
	Seat depth adjustment	Grade 5 / Grade-in D	\$703.00	Seat height 25" - 33"
	Grande Spider Package	Grade 6 / Grade-in E	\$723.00	Travel range (ht.) 3" (back) / 8" (seat)
	Dual-tone universal soft casters	LG1 (Evita) / C.O.L.	\$843.00	COM 1 yd.
		LG2 (Lena- <b>LDEL, LLUT, LORC only</b> )*	\$868.00	Carton / FedEx wt 60 lbs / 100 lbs
		LG3 (Vulcano- <b>LMIT, LSTG only</b> )*	\$898.00	Arms Group 1 & 4
				Warranty 12 year limited

\*For NON In-Stock colors, check with OM Seating for additional pricing details.



Besides the stools shown on this page, the AF413 (page 11), AF513 (page 20), DB52 (page 46), YS73 (page 174) contain the same "CLS control" and GSP understructure (i.e., 8" cylinder, fixed footing Spider base, 65mm dual-tone soft casters).

Chairs that are equipped with the GSP (Grande Spider Package) -- such as the CLS models on this page -- may be upgraded to a TLPKG option instead. The charge to do so (from a GSP) is **+\$55.56 list**, and the part code to do so is TLPKG.

**DESIGN STATEMENT** The design of the CLS Series is based upon a wish list of features that come from various Facility Managers that we've talked to over the years. It has a sturdy base and a comfortable, trouble-free footing, an easy-to-use ratchet back, seat depth adjustment, back angle adjustment and oversized casters that can go anywhere.

The low-maintenance CLS Series is just what the Facility Manager (and the lab technician) ordered!

## TLPKG



## GSPPKG (i.e., Grande Spider Package)

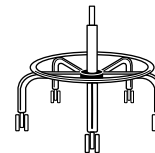

See pages 189 to 207 for a complete listing of all available arm, cylinder, caster, and other ergonomic options. Not all options may be applicable to a given model. Check with OM for compatibility details.

Above weights do not include optional arm kits. ; FedEx weight is calculated using FedEx dimensional standards to determine billable weight. ; Pricing and specifications subject to change without notification.

# Discovery Back

## Features:

- Begins @ \$631 armless / \$750 with KR200 arms (DB53)
- Ideal for ergonomic situations OR environments with heavy side-to-side tasking (i.e., nursing stations)
- Unusual backrest shape with functional ergonomic benefits like allowing full back "stretch"
- Proprietary TLC™ Technology (double-molded memory foam) standard in most backrest and some seat cushions (check model description for confirmation)
- Breadth of mechanism options from fully ergonomic to light, task-oriented adjustability



small / medium back

**Model**

DB53



300  
POUNDS  
CAPACITY

**Description**

*Simple Multi-Function (-7a)*

**Adjustable lumbar**

EZ back height adjustment

Infinitely locking seat tilt

Infinitely locking back tilt

Fabric panel back

Seat depth adjustment

TLC backrest (only)

**55mm multi-surface casters**

TLC TECHNOLOGY

**Textile Grade-In**

Grade 1 / C.O.M.

Grade 2 / Grade-in A

Grade 3 / Grade-in B

Grade 4 / Grade-in C

Grade 5 / Grade-in D

Grade 6 / Grade-in E

**List**

\$631.00

\$651.00

\$671.00

\$691.00

\$711.00

\$731.00

**Specifications**

Overall width 25"

Overall height 35" - 43"

Back 9.5" & 16.5" w x 20.5" h

Seat 20" w x 17-20.1" d

Seat height 16" - 21"

Travel range (ht.) 3" (back) / 5" (seat)

COM 1.5 yds.

Carton / FedEx wt 49 lbs / 101 lbs

Arms Group 1 & 4

Warranty 12 year limited

**Model**

DB64



300  
POUNDS  
CAPACITY

**Description**

*Full Multi-Function (-8b)*

**Adjustable lumbar**

EZ back height adjustment

Tilting backrest

Rocking tilt

Forward tilting adjustment

Tension knob

Fabric panel back

Seat depth adjustment

Infinite forward tilting

TLC backrest (only)

**55mm multi-surface casters**

**Textile Grade-In**

Grade 1 / C.O.M.

Grade 2 / Grade-in A

Grade 3 / Grade-in B

Grade 4 / Grade-in C

Grade 5 / Grade-in D

Grade 6 / Grade-in E

**List**

\$798.00

\$818.00

\$838.00

\$858.00

\$878.00

\$898.00

**Specifications**

Overall width 27"

Overall height 36" - 42"

Back 9.5" & 16.5" w x 20.5" h

Seat 20" w x 17.5-20.6" d

Seat height 17" - 22"

Travel range (ht.) 4" (back) / 5" (seat)

COM 1.5 yds.

Carton / FedEx wt 56 lbs / 101 lbs

Arms Group 1 & 4

Warranty 12 year limited

TLC TECHNOLOGY

Above weights do not include optional arm kits. ; FedEx weight is calculated using FedEx dimensional standards to determine billable weight. ; Pricing and specifications subject to change without notification.

Please see pages 47, 189 – 207 for arm kits, casters and other options.

high back

Model	Description	Textile Grade-In	List	Specifications
DB57	<i>Simple Multi-Function (-7a)</i>	Grade 1 / C.O.M.	\$718.00	Overall width 27"
	<b>Adjustable lumbar</b>	Grade 2 / Grade-in A	\$738.00	Overall height 39" - 51"
	EZ back height adjustment	Grade 3 / Grade-in B	\$758.00	Back 9.5" & 18" w x 23.5"h
	Infinitely locking seat tilt	Grade 4 / Grade-in C	\$778.00	Seat 21" w x 18-21.1" d
	Infinitely locking back tilt	Grade 5 / Grade-in D	\$798.00	Seat height 16" - 21"
	Fabric panel back	Grade 6 / Grade-in E	\$818.00	Travel range (ht.) 3" (back) / 5" (seat)
	Seat depth adjustment			COM 1.5 yds.
	TLC backrest (only)			Carton / FedEx wt 56 lbs / 101 lbs
	<b>55mm multi-surface casters</b>			Arms Group 1 & 4
				Warranty 12 year limited

300  
POUNDS  
CAPACITY

TLC TECHNOLOGY

Model	Description	Textile Grade-In	List	Specifications
DB68	<i>Full Multi-Function (-8b)</i>	Grade 1 / C.O.M.	\$840.00	Overall width 27"
	<b>Adjustable lumbar</b>	Grade 2 / Grade-in A	\$860.00	Overall height 41" - 48.5"
	EZ back height adjustment	Grade 3 / Grade-in B	\$880.00	Back 9.5" & 18" w x 23.5"h
	Tilting backrest	Grade 4 / Grade-in C	\$900.00	Seat 21" w x 18-21.1" d
	Rocking tilt	Grade 5 / Grade-in D	\$920.00	Seat height 18" - 23"
	Forward tilting adjustment	Grade 6 / Grade-in E	\$940.00	Travel range (ht.) 4" (back) / 5" (seat)
	Tension knob			COM 1.5 yds.
	Fabric panel back			Carton / FedEx wt 61 lbs / 101 lbs
	Seat depth adjustment			Arms Group 1 & 4
	<b>55mm multi-surface casters</b>			Warranty 12 year limited

300  
POUNDS  
CAPACITY

TLC TECHNOLOGY

Model	Description	Textile Grade-In	List	Specifications
DB74	<i>Full Multi-Function (-8a)</i>	Grade 1 / C.O.M.	\$876.00	Overall width 27"
	<b>Adjustable lumbar</b>	Grade 2 / Grade-in A	\$896.00	Overall height 40" - 49"
	EZ back height adjustment	Grade 3 / Grade-in B	\$916.00	Back 9.5" & 18" w x 23.5"h
	Infinitely locking seat tilt	Grade 4 / Grade-in C	\$936.00	Seat 20" w x 17-20.1" d
	Infinitely locking back tilt	Grade 5 / Grade-in D	\$956.00	Seat height 18" - 23"
	Forward tilting adjustment	Grade 6 / Grade-in E	\$976.00	Travel range (ht.) 4" (back) / 5" (seat)
	Rocking tension adjustment			COM 1.5 yds.
	Fabric panel back			Carton / FedEx wt 59 lbs / 101 lbs
	Seat depth adjustment			Arms Group 1 & 4
	<b>55mm multi-surface casters</b>			Warranty 12 year limited

300  
POUNDS  
CAPACITY

TLC TECHNOLOGY

extra-large back

Model	Description	Textile Grade-In	List	Specifications
DB78	<i>Full Multi-Function (-8a)</i>	Grade 1 / C.O.M.	\$950.00	Overall width 27"
	<b>Adjustable lumbar</b>	Grade 2 / Grade-in A	\$970.00	Overall height 43" - 52"
	EZ back height adjustment	Grade 3 / Grade-in B	\$990.00	Back 12" & 21.5" w x 25.5" h
	Infinitely locking seat tilt	Grade 4 / Grade-in C	\$1,010.00	Seat 22" w x 18-21.1" d
	Infinitely locking back tilt	Grade 5 / Grade-in D	\$1,030.00	Seat height 18" - 23"
	Forward tilting adjustment	Grade 6 / Grade-in E	\$1,050.00	Travel range (ht.) 4" (back) / 5" (seat)
	Rocking tension adjustment			COM 2 yds.
	Fabric panel back			Carton / FedEx wt 64 lbs / 101 lbs
	Seat depth adjustment			Arms Group 1 & 4
	<b>55mm multi-surface casters</b>			Warranty 12 year limited

300  
POUNDS  
CAPACITY

TLC TECHNOLOGY

Above weights do not include optional arm kits. ; FedEx weight is calculated using FedEx dimensional standards to determine billable weight. ; Pricing and specifications subject to change without notification.

# DB

Healthcare | Lab

Please see pages 47, 189 – 207 for arm kits, casters and other options.

stools

Model	Description	Textile Grade-In	List	Specifications
 <p><b>DB52</b></p> <p>300 POUNDS CAPACITY</p> <p>TLC TECHNOLOGY</p>	<i>Simple Multi-Function (-7aCLS)</i>	Grade 1 / C.O.M.	\$688.00	Overall width 27"
	<b>Adjustable lumbar</b>	Grade 2 / Grade-in A	\$708.00	Overall height 43" - 54"
	EZ back height adjustment	Grade 3 / Grade-in B	\$728.00	Back 9.5" & 16.5" w x 20.5" h
	Infinitely locking back tilt	Grade 4 / Grade-in C	\$748.00	Seat 20" w x 17-20.1" d
	Fabric panel back	Grade 5 / Grade-in D	\$768.00	Seat height 25" - 33"
	Seat depth adjustment	Grade 6 / Grade-in E	\$788.00	Travel range (ht.) 3" (back) / 8" (seat)
	Grande Spider Package			COM 1.5 yds.
	Dual-tone universal soft casters			Carton / FedEx wt 56 lbs / 100 lbs
	TLC backrest (only)			Arms Group 1 & 4
				Warranty 12 year limited

Model	Description	Textile Grade-In	List	Specifications
 <p><b>DB54</b></p> <p>300 POUNDS CAPACITY</p> <p>TLC TECHNOLOGY</p>	<i>Simple Multi-Function (-7aCLS)</i>	Grade 1 / C.O.M.	\$766.00	Overall width 27"
	<b>Adjustable lumbar</b>	Grade 2 / Grade-in A	\$786.00	Overall height 41" - 54"
	EZ back height adjustment	Grade 3 / Grade-in B	\$806.00	Back 9.5" & 16.5" w x 20.5" h
	Infinitely locking back tilt	Grade 4 / Grade-in C	\$826.00	Seat 20" w x 17-20.1" d
	Fabric panel back	Grade 5 / Grade-in D	\$846.00	Seat height 25" - 33"
	Seat depth adjustment	Grade 6 / Grade-in E	\$866.00	Travel range (ht.) 3" (back) / 10" (seat)
	Turn-lock footring			COM 1.5 yds.
	NEW aluminum base in matte black			Carton / FedEx wt 54 lbs / 101 lbs
	55mm black universal soft casters			Arms Group 1 & 4
	TLC backrest (only)			Warranty 12 year limited

Model	Description	Textile Grade-In	List	Specifications
 <p><b>DB56</b></p> <p>300 POUNDS CAPACITY</p> <p>TLC TECHNOLOGY</p>	<i>Simple Multi-Function (-7aCLS)</i>	Grade 1 / C.O.M.	\$853.00	Overall width 27"
	<b>Adjustable lumbar</b>	Grade 2 / Grade-in A	\$873.00	Overall height 45" - 58"
	EZ back height adjustment	Grade 3 / Grade-in B	\$893.00	Back 9.5" & 18" w x 23.5" h
	Infinitely locking back tilt	Grade 4 / Grade-in C	\$913.00	Seat 21" w x 18-21.1" d
	Fabric panel back	Grade 5 / Grade-in D	\$933.00	Seat height 23" - 33"
	Seat depth adjustment	Grade 6 / Grade-in E	\$953.00	Travel range (ht.) 3" (back) / 10" (seat)
	Turn-lock footring			COM 1.5 yds.
	NEW aluminum base in matte black			Carton / FedEx wt 59 lbs / 101 lbs
	55mm black universal soft casters			Arms Group 1 & 4
	TLC backrest (only)			Warranty 12 year limited

Above weights do not include optional arm kits. ; FedEx weight is calculated using FedEx dimensional standards to determine billable weight. ; Pricing and specifications subject to change without notification.



Please see pages 189 – 207 for arm kits, casters and other options.

### Suggested Options for DB Series

#### Arms

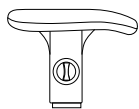

**KR21 (1D Motion)** - list: 70.00  
Fixed width, turn-knob height adjustable T-arms.  
For specs. and warranty, see page 192.



**KR100-45 (4D Motion)** (formerly KR445)  
- list: 185.00  
Height and width adjustable, removable T-arms with fore-aft, side-side, and inward pivoting arm top (RP-45).  
For specs. and warranty, see page 194.



**KR100-51M (4D Motion)** (formerly KR251M)  
- list: 205.00  
Height and width adjustable, removable T-arms with ultra-mobility arm tops that extend forward, pivot a full 360° at 2 different points; serves as a light-duty track arm to move with your hands as you work (RP-51M).  
For specs. and warranty, see page 195.



**KR100-65 (4D Motion)** (formerly KR465)  
- list: 195.00  
Height and width adjustable, removable T-arms with lockable arm top, fore-aft, side-side, pivoting arm top (RP-65).  
For specs. and warranty, see page 195.

#### Options

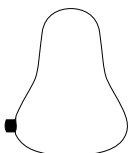

**Remove Adjustable Lumbar** - list: -76.00  
Option now standard on all 3 sizes of DB backrest – small, medium, large. To remove, subtract \$76 list.

See pages 189-207 for a complete listing of all available arm, cylinder, caster, and other ergonomic options.  
Not all options may be applicable to a given model. Check with OM for compatibility details.

**DISCOVERY BACK DESIGN BENEFITS** The special pear-back design of our Discovery Back series is designed specifically to address unhealthy seating postures. With a cut-away design to allow for full rearward travel of the scapula, DB chairs can help users who sit for long hours to develop habits for a healthier back.

**SCAPULAR IMPEDANCE** When reclining against a traditional backrest the shoulders are restricted from their full range of motion. This restriction of motion is referred to as scapular impedance, a condition that impedes the full range of motion and prevents beneficial stretching.

**THE 'HEALTHY BACK' DESIGN** According to the ergonomists and chiropractors with whom we have consulted, when people are seated in a chair with a full, 'normal' backrest, the body has a natural tendency to hunch forward. This predilection towards 'scrunching' is — with near uniform agreement — recognized as an unhealthy position for the human body to remain in, especially when seen in prolonged seating situations.

**NOTES** When upholstered in any Grade 5 ComfortKnit patterns (Solids, Architect, and Myth), DB Series back shells are upholstered in a high double-rub black fabric unless otherwise specified (for matching ComfortKnit backshell upholstery, see page 207 for pricing: DUB-K (formerly UPHDUB-T).



# Ginny

## Features:

- Begins @ \$451 armless / \$507 with arms
- Universal visitors' chair that complements any work or waiting room environment
- Wall saver rear legs and a vertical clean-through for ease-of-cleaning
- Choose from arms/armless, chrome or black frame, glides/ casters
- High-design flat oval tubing frame with glides or casters
- "Finished" frame design elegantly handles armless option (i.e., no abruptly truncated front leg frames)





# Ginny Guest (GY4-G)





Waiting rooms | Stackable | Guest seating

## Ginny Guest Core Features:

- Vertical Clean-out
- Stacks 3 high
- Wall Saver Rear Legs
- 300 lb. Weight Capacity
- Lifetime Limited Warranty



**Note:** Green font color indicates default build for "most popular" configuration of this spread.

1. Model		2. Arms		3. Frame and Frame/Arm Finishes		4. BackSHELL Upholstery	
Code	List	Code		Code	List	Code	List
<b>GY4-G</b> (with arms)	<b>\$507</b>	 <b>-N</b> No arms		<b>-BLK</b> Black powdercoat	<b>+\$0</b>	<b>-DUB-M*</b> Backshell matches <b>5. Back Upholstery Options</b> (next column)	<b>+\$0</b>
		 <b>-A</b> With arms	<b>+\$0</b>	<b>-SLR</b> Silver powdercoat	<b>+\$0</b>	<b>-DUB + Fabric Color #</b> Backshell (same grade, but different color and/or pattern)	Price one grade higher for <b>5. Back Upholstery</b>
		 <b>-LA</b> Left arm only	<b>-\$28</b>	<b>-CHM</b> Chrome	<b>+\$20</b>	<b>-DUB + Fabric Color #</b> Backshell (different grade back & backshell upholstery)	Use higher grade price of the two for <b>5. Back Upholstery</b>
		 <b>-RA</b> Right arm only	<b>-\$28</b>	<b>With Arms</b>		<b>-DUB-B</b> Ballistic nylon backshell	<b>+\$80</b>
				<b>-BKCM</b> <b>Color Match Black</b> • Black powdercoat frame • Black arm pads	<b>+\$0</b>	*Price does not apply to <b>-DUB-B</b> and <b>-UPH-PDF</b> options when specified together.	
				<b>-SLGR</b> • Silver powdercoat frame • Grey arm pads	<b>+\$0</b>	Backshell Upholstery Notes: 1. When upholstered in any Grade 5 ComfortKnit patterns (Solids, Architect, and Myth), Ginny Series backshells are upholstered in a high double rub black fabric unless otherwise specified (for matching ComfortKnit backshell upholstery see OTHER OPTIONS below: DUB-K).	
				<b>-CHBK</b> • Chrome frame • Black arm pads	<b>+\$20</b>	2. Leather Grade 1 (LG1) Evita may use "closest available" matching vinyl with leather-like texture.	
				<b>-CHGR</b> • Chrome frame • Grey arm pads	<b>+\$20</b>	3. Leather Grades 2, 3 (LG2, LG3) use Lena or Vulcano to match Back Upholstery Option.	
						4. For additional details and pricing — contact OM.	

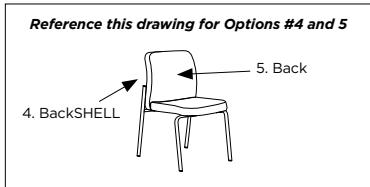

## OTHER OPTIONS (append to above nomenclature to add to, or override existing options)

Backshell and Back Options	List	Seat Options	List	Ganging Bar	List
<b>-TB133-2</b> Seat and back upholstery with fire barrier to meet CA TB133.	<b>+\$119</b>	<b>-CFT</b> Memory foam insert for additional comfort	<b>+\$66</b>	<b>-GNBLK</b> Black armless ganging bar (0" between ganged chairs)	<b>+\$25</b>
<b>-UPH-PD</b> Ballistic nylon back	<b>+\$70</b>			<b>-GABLK</b> Black arm ganging bar (1.75" between ganged chairs)	<b>+\$30</b>
<b>-DUB-K</b> ComfortKnit patterns backshell (Solids, Architect and Myth)	<b>+\$70</b>			<b>-GNSLR</b> Silver armless ganging bar (0" between ganged chairs)	<b>+\$25</b>
				<b>-GASLR</b> Silver arm ganging bar (1.75" between ganged chairs)	<b>+\$30</b>

Note: TB133 is an option only in select States where it is not banned due to potentially health-adverse reasons. Verify with your state, and client, to ensure this option is truly needed and permitted before ordering."

### Ginny Ganging Bar Notes:

- Ganging bars (& mounting bolts) are sold in pairs for connecting Ginny chairs with their neighbor.
- To calculate quantity: Total Ginny - 1 = qty. of ganging bars.



**MODEL CODE**

Example: GY4-G - A - BKCM - DUB-M - 3P30 - 3P30 - GLD (new format) = GY4G - A - DUB-M - 3P30 - 3P30 - etc. (original format)

Model #   Arm   Finish   Backshell uph.   Back uph.   Seat uph.   Caster   Model #   Arm   Backshell uph.   Back uph.   Seat uph.

5. Back Upholstery	
Code	List
• Grade 1 / C.O.M.	+\$0
• Grade 2 / Grade-in A	+\$15
• Grade 3 / Grade-in B	+\$30
• Grade 4 / Grade-in C	+\$45
• Grade 5 / Grade-in D	+\$60
• Grade 6 / Grade-in E	+\$75
-UPH-PDF** Ballistic nylon complete front	+\$110
• LG1 Evita / C.O.L.	+\$110
• LG2 Lena - LDEL, LLUT, LORC only*	+\$125
• LG3 Vulcano - LMIT, LSTG only*	+\$145

6. Seat Upholstery	
Code	List
• Grade 1 / C.O.M.	+\$0
• Grade 2 / Grade-in A	+\$10
• Grade 3 / Grade-in B	+\$20
• Grade 4 / Grade-in C	+\$30
• Grade 5 / Grade-in D	+\$40
• Grade 6 / Grade-in E	+\$50
• LG1 Evita / C.O.L.	+\$110
• LG2 Lena - LDEL, LLUT, LORC only*	+\$120
• LG3 Vulcano - LMIT, LSTG only*	+\$130

7. Caster*		
Code		List
	-GLD Glides	+\$0
	-SC Soft casters	+\$25

\*Glides and casters are not interchangeable after order.

\*For NON In-Stock colors, check with OM Seating for additional pricing details.

\*For NON In-Stock colors, check with OM Seating for additional pricing details.

\*\*Price does not apply to -DUB-B and -UPH-PDF options when specified together.

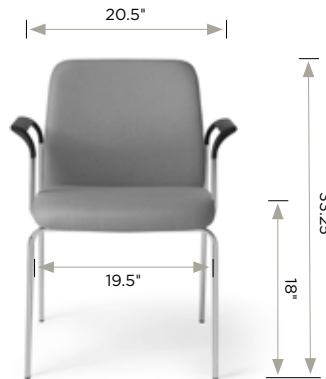

Dimensions	W	D	H
Overall w/ arms	25.25"	24.5"	33.25"
Overall w/o arms	20.5"	24.5"	33.25"
Arm	1.875"	N/A	26.5" from floor
Seat	19.5"	18"	18"
Back	19.5"	N/A	16"

Upholstery	Back	Seat	Backshell
COM*	0.8 yd.	0.8 yd.	0.7 yd.
Shipping	Carton Wt.	FedEx Wt.	
	39 lbs.	121 lbs.	

\*for big pattern repeats, check with OM



# Ginny Bariatric (GY4-B)



Waiting rooms | Guest seating

## Ginny Bariatric Core Features:

- Vertical Clean-out
- Stacks 3 high
- Wall Saver Rear Legs
- 500 lb. Weight Capacity
- 7 year Limited Warranty



**Note:** Green font color indicates default build for "most popular" configuration of this spread.

1. Model		2. Arms		3. Frame and Frame/arm Finishes		4. BackSHELL Upholstery	
Code	List	Code	List	Code	List	Code	List
<b>GY4-B-26</b> (26" seat width)	<b>\$904</b>		N/A	<b>-BKCM</b> (formerly <i>BLK</i> ) <b>Color Match Black</b> • Black powdercoat frame • Black arm pads	<b>+\$0</b>	<b>-DUB-M*</b> Backshell matches <b>5. Back Upholstery Options</b> (next column)	<b>+\$0</b>
<b>GY4-B-30</b> (30" seat width)	<b>\$1,130</b>		<b>-A</b> With arms	<b>-SLGR</b> (formerly <i>SLR</i> ) • Silver powdercoat frame • Grey arm pads	<b>+\$20</b>	<b>-DUB + Fabric Color #</b> Backshell (same grade, but different color and/or pattern)	Price one grade higher for <b>5. Back Upholstery</b>
						<b>-DUB + Fabric Color #</b> Backshell (different grade back & backshell upholstery)	Use higher grade price of the two for <b>5. Back Upholstery</b>
						<b>-DUB-B</b> Ballistic nylon backshell	<b>+\$110</b>

\*Price does not apply to **-DUB-B** and **-UPH-PDF** options when specified together.

### Backshell Upholstery Notes:

1. Leather Grade 1 (LG1) Evita may use "closest available" matching vinyl with leather-like texture.
2. Leather Grades 2, 3 (LG2, LG3) use Lena or Vulcano to match Back Upholstery Option.
3. For additional details and pricing — contact OM.

Reference this drawing for Options #4 and 5

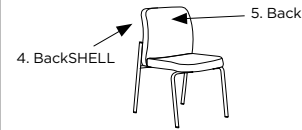

## OTHER OPTIONS (append to above nomenclature to add to, or override existing options)

Backshell and Back Options	List	Ganging Bar	List
<b>-TB133-3</b> Seat and back upholstery with fire barrier to meet CA TB133.	<b>+\$158</b>	<b>-GABLK</b> Black arm ganging bar (1.75" between ganged chairs)	<b>+\$30</b>
<b>-UPH-PD</b> Ballistic nylon back	<b>+\$98</b>	<b>-GASLR</b> Silver arm ganging bar (1.75" between ganged chairs)	<b>+\$30</b>

### Ginny Ganging Bar Notes:

1. Ganging bars (& mounting bolts) are sold in pairs for connecting Ginny chairs with their neighbor.
2. To calculate quantity: Total Ginny - 1 = qty. of ganging bars.

Note: TB133 is an option only in select States where it is not banned due to potentially health-adverse reasons. Verify with your state, and client, to ensure this option is truly needed and permitted before ordering.

**MODEL CODE**

Example: GY4-B-30 - A - BKCM - DUB-M - 3P30 - 3P30 - GLD (new format) = GY4B-30 - A - DUB-M - 3P30 - etc. (original format)

Model #    Arm    Finish    Backshell uph.    Back uph.    Seat uph.    Caster    Model #    Arm    Backshell uph.    Back uph.

5. Back Upholstery	
Code	List
• Grade 1 / C.O.M.	+\$0
• Grade 2 / Grade-in A	+\$15
• Grade 3 / Grade-in B	+\$30
• Grade 4 / Grade-in C	+\$45
• Grade-in D	+\$60
• Grade 6 / Grade-in E	+\$75
<b>-UPH-PDF*</b> Ballistic nylon complete front	<b>+\$138</b>

6. Seat Upholstery	
Code	List
• Grade 1 / C.O.M.	+\$0
• Grade 2 / Grade-in A	+\$15
• Grade 3 / Grade-in B	+\$30
• Grade 4 / Grade-in C	+\$45
• Grade-in D	+\$60
• Grade 6 / Grade-in E	+\$75

Caster		
Code		List
	-GLD Glides	+\$0

\*Price does not apply to **-DUB-B** and **-UPH-PDF** options when specified together.

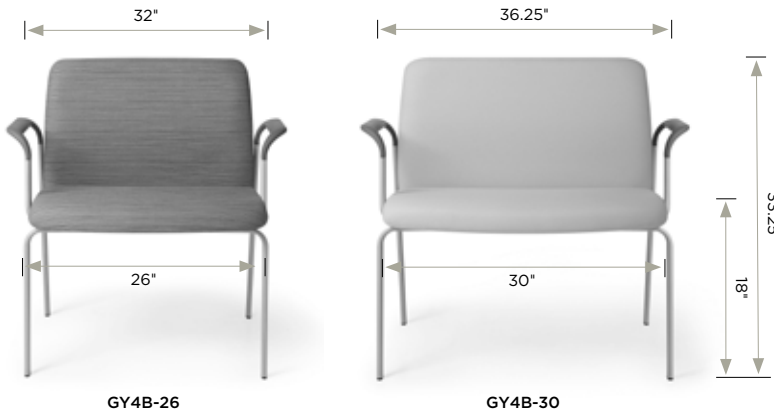

GY4B-26 Dimensions	W	D	H
Overall	32"	24.5"	33.25"
Seat	26"	18"	18"
Back	26"	N/A	16"

GY4B-30 Dimensions	W	D	H
Overall	36.25"	24.5"	33.25"
Seat	30"	18"	18"
Back	30"	N/A	16"

Upholstery	Back	Seat	Backshell
COM*	0.8 yd.	0.8 yd.	0.7 yd.
Shipping	Carton Wt.	FedEx Wt.	
GY4B-26	56 lbs.	N/A	
GY4B-30	61 lbs.	N/A	

\*for big pattern repeats, check with OM



# Ginny Multi-Tasker (GY4-T)





Light Multi-Tasker | Collaborative | Small Conference

### Ginny Tasker Core Features:

- Height Adjustable Swivel Tasker
- Mix and Match Upholstery Options
- 300 lb. Weight Capacity
- Lifetime Limited Warranty



**Note:** Green font color indicates default build for "most popular" configuration of this spread.

1. Model		2. Mechanism Options			3. Arm Finish Options			4. BackSHELL Upholstery Options	
Code	List	Code		List	Code		List	Code	List
<b>GY4-T</b> (with arms)	<b>\$599</b>		<b>-TOB</b> <b>Fixed Mechanism</b> • Height adjustable	<b>-\$10</b>		<b>-N</b> (no arm)	<b>-\$56</b>	<b>-DUB-M*</b> Backshell matches <b>5. Back Upholstery Options</b> (next column)	<b>+\$0</b>
			<b>-T1a</b> <b>Tilt Mechanism</b> • Height adjustable • Light tilt motion	<b>+\$0</b>		<b>-A-BKCM</b> <b>Color Match Black</b> • Black frame • Black arm pads	<b>+\$0</b>	<b>-DUB + Fabric Color #</b> Backshell (same grade, but different color and/or pattern)	Price one grade higher for <b>5. Back Upholstery</b>
						<b>-A-CHBK</b> • Chrome frame • Black arm pads	<b>+\$20</b>	<b>-DUB + Fabric Color #</b> Backshell (different grade back & backshell upholstery)	Use higher grade price of the two for <b>5. Back Upholstery</b>
						<b>-A-CHGR</b> • Chrome frame • Grey arm pads	<b>+\$30</b>	<b>-DUB-B</b> Ballistic nylon backshell	<b>+\$80</b>



\*Price does not apply to **-DUB-B** and **-UPH-PDF** options when specified together.

#### Backshell Upholstery Notes:

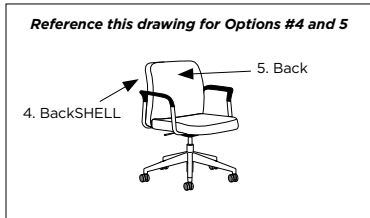
1. When upholstered in any Grade 5 ComfortKnit patterns (Solids, Architect, and Myth), Ginny Series backshells are upholstered in a high double rub black fabric unless otherwise specified (for matching ComfortKnit backshell upholstery see OTHER OPTIONS below: DUB-K).
2. Leather Grade 1 (LG1) Evita may use "closest available" matching vinyl with leather-like texture.
3. Leather Grades 2, 3 (LG2, LG3) use Lena or Vulcano to match Back Upholstery Option.
4. For additional details and pricing — contact OM.



### OTHER OPTIONS (append to above nomenclature to add to, or override existing options)

Backshell and Back Options		Seat Options		Caster Options		
	List		List		Grade	List
<b>-UPH-PD</b> Ballistic nylon lower back	<b>+\$70</b>	<b>-CFT</b> Memory foam insert for additional comfort	<b>+\$66</b>		<b>-65MS</b> 65mm grey two-tone multi-surface soft casters	<b>\$25</b>
<b>-DUB-K</b> ComfortKnit Patterns Backshell (Solids, Architect and Myth)	<b>+\$70</b>				<b>-GLDR</b> Glides	<b>+\$0</b>
					<b>-5OSS</b> 50mm safety soft casters, minimizes chair movement when NOT in use	<b>\$25</b>



## ORDER NOMENCLATURE

Example: GY4-T — T1a — A-BKCM — DUB-M — 3P30 — 3P30 — STDB (new format code)

Model #    Mech.    Arm    Backshell fabric    Back fabric    Seat fabric    Base Pkg

5. Back Upholstery		6. Seat Upholstery		7. Base Packages (includes cylinder, base, and casters)	
Code	List	Code	List	Code	List
• Grade 1 / C.O.M.	+\$0	• Grade 1 / C.O.M.	+\$0	<b>Black Base Package Options:</b>	
• Grade 2 / Grade-in A	+\$15	• Grade 2 / Grade-in A	+\$10	<b>-XSB (formerly LP-B)</b> <b>Low Seat Height Package (Black)</b> (Seat Height: 15.5" - 19.5") • <b>Cylinder:</b> 4" black (4BCE) • <b>Base:</b> 28" black nylon (28NXT) • <b>Casters:</b> 55mm black two-tone multi-surface (55MSB)	+\$30
• Grade 3 / Grade-in B	+\$30	• Grade 3 / Grade-in B	+\$20	<b>-STDB (formerly SP-B)</b> <b>Standard Seat Height Package (Black)</b> (Seat Height: 17" - 22") • <b>Cylinder:</b> 5" black (5BM) • <b>Base:</b> 28" black nylon (28NXT) • <b>Casters:</b> 55mm black two-tone multi-surface (55MSB)	+\$0
• Grade 4 / Grade-in C	+\$45	• Grade 4 / Grade-in C	+\$30	<b>-HIB</b> <b>High Seat Height Package (Black)</b> (Seat Height: 18.5" - 23.5") • <b>Cylinder:</b> 5" black (5BWY) • <b>Base:</b> 28" black nylon (28NXT) • <b>Casters:</b> 55mm black two-tone multi-surface (55MSB)	+\$30
• Grade 5 / Grade-in D	+\$60	• Grade 5 / Grade-in D	+\$40	<b>Polished Base Package Options:</b>	
• Grade 6 / Grade-in E	+\$75	• Grade 6 / Grade-in E	+\$50	<b>-XSP (formerly LP-P)</b> <b>Low Seat Height Package (Polished)</b> (Seat Height: 15.5" - 19.5") • <b>Cylinder:</b> 4" chrome (4CCE) • <b>Base:</b> 28" polished aluminum (28PXT) • <b>Casters:</b> 55mm black two-tone multi-surface (55MSB)	+\$80
<b>-UPH-PDF**</b> Ballistic nylon complete front	+\$110	• LG1 Evita / C.O.L.	+\$110	<b>-STDP (formerly SP-P)</b> <b>Standard Seat Height Package (Polished)</b> (Seat Height: 17" - 22") • <b>Cylinder:</b> 5" chrome (5CM) • <b>Base:</b> 28" polished aluminum (28PXT) • <b>Casters:</b> 55mm black two-tone multi-surface (55MSB)	+\$70
• LG1 Evita / C.O.L.	+\$110	• LG2 Lena - LDEL, LLUT, LORC only*	+\$120	<b>-HIP</b> <b>High Seat Height Package (Polished)</b> (Seat Height: 18.5" - 23.5") • <b>Cylinder:</b> 5" chrome (5CR) • <b>Base:</b> 28" polished aluminum (28PXT) • <b>Casters:</b> 55mm black two-tone multi-surface (55MSB)	+\$80
• LG2 Lena - LDEL, LLUT, LORC only*	+\$125	• LG3 Vulcano - LMIT, LSTG only*	+\$130		
• LG3 Vulcano - LMIT, LSTG only*	+\$145	*For NON In-Stock colors, check with OM Seating for additional pricing details.			

\*For NON In-Stock colors, check with OM Seating for additional pricing details.

\*\*Price does not apply to **-DUB-B** and **-UPH-PDF** options when specified together.



Dimensions	W	D	H
Overall	28"	28"	32" - 37"
Seat	19.5"	18"	17" - 22"
Back	19.5"	N/A	16"

Upholstery	Back	Seat	Backshell
COM*	0.8 yd.	0.8 yd.	0.7 yd.
Shipping	Carton Wt.	FedEx Wt.	
	38 lbs.	121 lbs.	

\*for big pattern repeats, check with OM



# Ginny Multi-Tasker Stool (GY4-TS)





Light Tasker Stool | Collaborative

## Ginny Tasker Stool Core Features:

- Height Adjustable Stool with 20" adjustable footring
- 300 lb. Weight Capacity
- Lifetime Limited Warranty



**Note:** Green font color indicates default build for "most popular" configuration of this spread.

1. Model		2. Mechanism Options		3. Arm Finish Options		4. BackSHELL Upholstery Options	
Code	List	Code	List	Code	List	Code	List
<b>GY4-TS</b> <i>(formerly GY4T-LS) (with arms)</i>	<b>\$723</b>	 <b>-T0b</b> <b>Fixed Mechanism</b> • Height adjustable	<b>+\$0</b>	 <b>-N</b> (no arm)	<b>-\$56</b>	<b>-DUB-M*</b> Backshell matches <b>5. Back Upholstery Options</b> (next column)	<b>+\$0</b>
				 <b>-A-BKCM</b> <b>Color Match Black</b> • Black frame • Black arm pads	<b>+\$0</b>	<b>-DUB + Fabric Color #</b> Backshell (same grade, but different color and/or pattern)	Price one grade higher for <b>5. Back Upholstery</b>
				 <b>-A-CHBK</b> • Chrome frame • Black arm pads	<b>+\$20</b>	<b>-DUB + Fabric Color #</b> Backshell (different grade back & backshell upholstery)	Use higher grade price of the two for <b>5. Back Upholstery</b>
				 <b>-A-CHGR</b> • Chrome frame • Grey arm pads	<b>+\$30</b>	<b>-DUB-B</b> Ballistic nylon backshell	<b>+\$80</b>

\*Price does not apply to **-DUB-B** and **-UPH-PDF** options when specified together.



### Backshell Upholstery Notes:

1. When upholstered in any Grade 5 ComfortKnit patterns (Solids, Architect, and Myth), Ginny Series backshells are upholstered in a high double rub black fabric unless otherwise specified (for matching ComfortKnit backshell upholstery see OTHER OPTIONS below: DUB-K).
2. Leather Grade 1 (LG1) Evita may use "closest available" matching vinyl with leather-like texture.
3. Leather Grades 2, 3 (LG2, LG3) use Lena or Vulcano to match Back Upholstery Option.
4. For additional details and pricing — contact OM.

**Reference this drawing for Options #4 and 5**



## OTHER OPTIONS (append to above nomenclature to add to, or override existing options)

Backshell and Back Options		Seat Options		Caster Options		
	List		List		Grade	List
<b>-UPH-PD</b> Ballistic nylon lower back	<b>+\$70</b>	<b>-CFT</b> Memory foam insert for additional comfort	<b>+\$66</b>		<b>-65MS</b> 65mm grey two-tone multi-surface soft casters	<b>\$25</b>
<b>-DUB-K</b> ComfortKnit Patterns Backshell (Solids, Architect and Myth)	<b>+\$70</b>				<b>-GLDR</b> Glides	<b>+\$0</b>
					<b>-50SS</b> 50mm safety soft casters, minimizes chair movement when NOT in use.	<b>\$25</b>

## ORDER NOMENCLATURE

Example: GY4-TS — T0b — A-BKCM — DUB-M — 3P30 — 3P30 — 8TLB (new format code)

Model #    Mech.    Arm    Backshell fabric    Back fabric    Seat fabric    Base Pkg

5. Back Upholstery		6. Seat Upholstery		7. Base Packages (includes cylinder, footring, base, and casters)	
Code	List	Code	List	Code	List
• Grade 1 / C.O.M.	+\$0	• Grade 1 / C.O.M.	+\$0	-8TLB (formerly STL-B) Standard Height Package with Adjustable Footring (Black)(Seat Height: 22" - 30") • Cylinder: 8" black (8BAT) • Footring: 20" Turn-lock Footring • Base: 28" black nylon (28NXT) • Casters: 55mm black two-tone multi-surface (55MSB)	+\$0
• Grade 2 / Grade-in A	+\$15	• Grade 2 / Grade-in A	+\$10	-8TLP (formerly STL-P) Standard Height Package with Adjustable Footring (Polished) (Seat Height: 22" - 30") • Cylinder: 8" chrome heavy duty (8CHD) • Footring: 20" Turn-lock Footring • Base: 28" polished aluminum (28PXT) • Casters: 55mm black two-tone multi-surface (55MSB)	+\$80
• Grade 3 / Grade-in B	+\$30	• Grade 3 / Grade-in B	+\$20		
• Grade 4 / Grade-in C	+\$45	• Grade 4 / Grade-in C	+\$30		
• Grade 5 / Grade-in D	+\$60	• Grade 5 / Grade-in D	+\$40		
• Grade 6 / Grade-in E	+\$75	• Grade 6 / Grade-in E	+\$50		
-UPH-PDF** Ballistic nylon complete front	+\$110	• LG1 Evita / C.O.L.	+\$110		
• LG1 Evita / C.O.L.	+\$110	• LG2 Lena - LDEL, LLUT, LORC only*	+\$120		
• LG2 Lena - LDEL, LLUT, LORC only*	+\$125	• LG3 Vulcano - LMIT, LSTG only*	+\$130		
• LG3 Vulcano - LMIT, LSTG only*	+\$145				

\*For NON In-Stock colors, check with OM Seating for additional pricing details.

\*For NON In-Stock colors, check with OM Seating for additional pricing details.

\*\*Price does not apply to -DUB-B and -UPH-PDF options when specified together.



Dimensions	W	D	H
Overall	28"	28"	37" - 45"
Seat	19.5"	18"	22" - 30"
Back	19.5"	N/A	16"

Upholstery	Seat	Back	Backshell
COM*	0.8 yd.	0.8 yd.	0.7 yd.
Shipping	Carton Wt.	FedEx Wt.	
	48 lbs.	121 lbs.	

\*for big pattern repeats, check with OM



# Intensive use 24/7

(To be renamed "PTIU", "PTHD", & "PTPD" in 2024)

## Features:

- Begins @ \$810 armless / \$929 with KR200 arms (IU54)
- Ever feel like you're working 28 hours/day? IU and IUHD chairs are right there with you!
- Aesthetic complement to the PT series, but with long-lasting and/or heavy-duty parts
- Engineered composite bases, heavy-duty reinforced cylinders and mechanisms (IUHD/IUPD)
- Proprietary TLC Technology (Two-Layer Comfort) standard in IUHD/PD seats



# Intensive Use 24-7 (IU)

(IU | to be renamed "PTIU" in 2024)

Multi-shift | Intense-use

Please see pages 61, 189 – 207 for arm kits, casters, and other options.

average / medium

## Model

IU54

(aka, PTIU54)



300  
POUNDS  
CAPACITY

## Description

*Simple Multi-Function (-7b)*  
Pneumatic lift  
EZ back height adjustment  
Independent seat and back  
angle adjustment  
Seat depth adjustment  
Flat panel back  
55mm multi-surface casters (STD)

## Textile Grade-In

Grade 1 / C.O.M.	\$810.00
Grade 2 / Grade-in A	\$830.00
Grade 3 / Grade-in B	\$850.00
Grade 4 / Grade-in C	\$870.00
Grade 5 / Grade-in D	\$890.00
Grade 6 / Grade-in E	\$910.00

## List

## Specifications

Overall width	27"
Overall height	38" - 47"
Back	20" w x 20" h
Seat	21" w x 17.9-21" d
Seat height	17" - 22"
Travel range (ht.)	4" (back) / 5" (seat)
COM	1.5 yds.
Carton / FedEx wt	48 lbs / 101 lbs
Arms	Group 1 & 4
Warranty	7 year limited

## Model

IU72

(aka, PTIU72)



300  
POUNDS  
CAPACITY

## Description

*Simple Multi-Function (-7b)*  
Pneumatic lift  
EZ back height adjustment  
Independent seat and back  
angle adjustment  
Seat depth adjustment  
55mm multi-surface casters (STD)

## Textile Grade-In

Grade 1 / C.O.M.	\$810.00
Grade 2 / Grade-in A	\$830.00
Grade 3 / Grade-in B	\$850.00
Grade 4 / Grade-in C	\$870.00
Grade 5 / Grade-in D	\$890.00
Grade 6 / Grade-in E	\$910.00

## List

## Specifications

Overall width	27"
Overall height	36" - 45"
Back	17" w x 18" h
Seat	20" w x 17-20.1" d
Seat height	17" - 22"
Travel range (ht.)	4" (back) / 5" (seat)
COM	1 yd.
Carton / FedEx wt	54 lbs / 101 lbs
Arms	Group 1 & 4
Warranty	7 year limited

large

## Model

IU58

(aka, PTIU58)



300  
POUNDS  
CAPACITY

## Description

*Simple Multi-Function (-7b)*  
Pneumatic lift  
EZ back height adjustment  
Independent seat and back  
angle adjustment  
Seat depth adjustment  
Fabric panel back  
55mm multi-surface casters (STD)

## Textile Grade-In

Grade 1 / C.O.M.	\$872.00
Grade 2 / Grade-in A	\$892.00
Grade 3 / Grade-in B	\$912.00
Grade 4 / Grade-in C	\$932.00
Grade 5 / Grade-in D	\$952.00
Grade 6 / Grade-in E	\$972.00

## List

## Specifications

Overall width	27"
Overall height	43" - 52"
Back	20" w x 24" h
Seat	21" w x 17.9-21" d
Seat height	17" - 22"
Travel range (ht.)	4" (back) / 5" (seat)
COM	2 yds.
Carton / FedEx wt	55 lbs / 101 lbs
Arms	Group 1 & 4
Warranty	7 year limited

## Model

IU76

(aka, PTIU76)



300  
POUNDS  
CAPACITY

## Description

*Simple Multi-Function (-7b)*  
Pneumatic lift  
EZ back height adjustment  
Independent seat and back  
angle adjustment  
Seat depth adjustment  
55mm multi-surface casters (STD)

## Textile Grade-In

Grade 1 / C.O.M.	\$872.00
Grade 2 / Grade-in A	\$892.00
Grade 3 / Grade-in B	\$912.00
Grade 4 / Grade-in C	\$932.00
Grade 5 / Grade-in D	\$952.00
Grade 6 / Grade-in E	\$972.00

## List

## Specifications

Overall width	27"
Overall height	40" - 48"
Back	19.5" w x 22" h
Seat	21" w x 18-21.1" d
Seat height	17" - 22"
Travel range (ht.)	4" (back) / 5" (seat)
COM	1.5 yds.
Carton / FedEx wt	57 lbs / 101 lbs
Arms	Group 1 & 4
Warranty	7 year limited

Above weights do not include optional arm kits. ; FedEx weight is calculated using FedEx dimensional standards to determine billable weight. ; Pricing and specifications subject to change without notification.

# Intensive Use 24-7 (IU)

(IU | to be renamed "PTIU" in 2024)

Multi-shift | Intense-use

Please see pages 189 – 207 for arm kits, casters, and other options.

## stools

### Model

IU55

(aka, PTIU55)



300  
POUNDS  
CAPACITY

### Description

Simple Multi-Function (-7b)

Pneumatic lift

EZ back height adjustment

Independent seat and back

angle adjustment

Seat depth adjustment

Fabric panel back

20" chrome footring

Turn-Lock footring

Optional 8" cylinder available

(21" - 29")

55mm multi-surface casters (STD)

### Textile Grade-In

Grade 1 / C.O.M.

Grade 2 / Grade-in A

Grade 3 / Grade-in B

Grade 4 / Grade-in C

Grade 5 / Grade-in D

Grade 6 / Grade-in E

### List

\$885.00

\$905.00

\$925.00

\$945.00

\$965.00

\$985.00

### Specifications

Overall width 27"

Overall height 45" - 59"

Back 20" w x 20" h

Seat 21" w x 17-20.1" d

Seat height 24" - 34"

Travel range (ht.) 4" (back) / 10" (seat)

COM 1.5 yds.

Carton / FedEx wt 53 lbs / 101 lbs

Arms Group 1 & 4

Warranty 7 year limited

### Model

IU73

(aka, PTIU73)



300  
POUNDS  
CAPACITY

### Description

Simple Multi-Function (-7b)

Pneumatic lift

EZ back height adjustment

Independent seat and back

angle adjustment

Seat depth adjustment

20" chrome footring

Turn-Lock footring

Optional 8" cylinder available

(21" - 29")

55mm multi-surface casters (STD)

### Textile Grade-In

Grade 1 / C.O.M.

Grade 2 / Grade-in A

Grade 3 / Grade-in B

Grade 4 / Grade-in C

Grade 5 / Grade-in D

Grade 6 / Grade-in E

### List

\$885.00

\$905.00

\$925.00

\$945.00

\$965.00

\$985.00

### Specifications

Overall width 27"

Overall height 43" - 57"

Back 17" w x 18" h

Seat 20" w x 17-20.1" d

Seat height 24" - 34"

Travel range (ht.) 4" (back) / 10" (seat)

COM 1 yd.

Carton / FedEx wt 59 lbs / 101 lbs

Arms Group 1 & 4

Warranty 7 year limited

## common options

### Arms

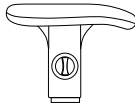

**KR21 (1D Motion)** - list: 70.00

Fixed width, turn-knob height adjustable T-arms.

For specs and warranty, see page 192.



**KR25 (1D Motion)** - list: 70.00

Fixed width, height adjustable T-arms featuring natural grip control

For specs and warranty, see page 192.



**KR200 (2D Motion)** - list: 119.00

Height and width adjustable, removable T-arms with natural grip control.

For specs and warranty, see page 193.

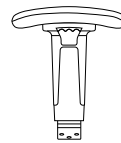

**JR77 (1D Motion)** - list: 100.00

Fixed width, height adjustable T-arms with molded arm pads.

For specs and warranty, see page 192.

See pages 189 to 207 for a complete listing of all available arm, cylinder, caster, and other ergonomic options. Not all options may be applicable to a given model. Check with OM for compatibility details.

Intensive Use 24-Seven Series designed to accommodate users up to 300 pounds.

IU: Intensive Use (aka, 24/7 environments), HD: Heavy-Duty (i.e. for occupants weighing up to 350 lbs.)

**NOTE:** When upholstered in any Grade 5 ComfortKnit patterns (Solids, Architect, and Myth) IU Series back shells are upholstered in a high double-rub black fabric unless otherwise specified.

Above weights do not include optional arm kits. ; FedEx weight is calculated using FedEx dimensional standards to determine billable weight. ; Pricing and specifications subject to change without notification.

# Intensive Use 24-7 (IUHD/PD)

(IUHD/PD | to be renamed "PTHD/PTPD" in 2024)

Heavy-duty

Please see pages 63, 189 – 207 for arm kits, casters, and other options.

average / mid back

Model	Description	Textile Grade-In	List	Specifications
<b>IU76HD</b> (aka, PT76HD)	<i>Simple Multi-Function (-7HD)</i>	Grade 1 / C.O.M.	\$1,118.00	Overall width 28"
	Pneumatic lift	Grade 2 / Grade-in A	\$1,138.00	Overall height 40" - 48"
	Tilting backrest	Grade 3 / Grade-in B	\$1,158.00	Back 19.5" w x 22" h
	EZ back height adjustment	Grade 4 / Grade-in C	\$1,178.00	Seat 22" w x 18-21.1" d
	Rocking tilt	Grade 5 / Grade-in D	\$1,198.00	Seat height 17" - 22"
	Tension knob	Grade 6 / Grade-in E	\$1,218.00	Travel range (ht.) 4" (back) / 5" (seat)
	Seat tilting			COM 1.5 yds.
	Seat depth adjustment			Carton / FedEx wt 57 lbs / 101 lbs
	Heavy-duty structure			Arms Group 1* & 4
	Dual-tone universal soft casters			*no KR23, KR23-45, KR23-65
TLC seat			Warranty 7 year limited	



Model	Description	Textile Grade-In*	List	Specifications
<b>IU76PD</b> (aka, PT76PD)	<i>Simple Multi-Function (-7HD)</i>	Grade 1 / C.O.M.	\$1,188.00	Overall width 28"
	Pneumatic lift	Grade 2 / Grade-in A	\$1,208.00	Overall height 40" - 48"
	Tilting backrest	Grade 3 / Grade-in B	\$1,228.00	Back 19.5" w x 22" h
	EZ back height adjustment	Grade 4 / Grade-in C	\$1,248.00	Seat 22" w x 18-21.1" d
	Rocking tilt			Seat height 17" - 22"
	Tension knob			Travel range (ht.) 4" (back) / 5" (seat)
	Seat tilting			COM 1.5 yds.
	Seat depth adjustment			Carton / FedEx wt 57 lbs / 101 lbs
	Heavy-duty structure			Arms Group 1* & 4
	Lower back reinforced with ballistic nylon			*no KR23, KR23-45, KR23-65
Dual-tone universal soft casters			Warranty 7 year limited	
TLC seat				



large / xtra tall

Model	Description	Textile Grade-In	List	Specifications
<b>IU79HD</b> (aka, PT79HD)	<i>Simple Multi-Function (-7HD)</i>	Grade 1 / C.O.M.	\$1,231.00	Overall width 28"
	Pneumatic lift	Grade 2	\$1,256.00	Overall height 46.5" - 54.5"
	Tilting backrest	Grade 3 / Grade-in A	\$1,281.00	Back 19.5" w x 28" h
	EZ back height adjustment	Grade 4 / Grade-in B	\$1,306.00	Seat 22" w x 18-21.1" d
	Rocking tilt	Grade 5 / Grade-in C	\$1,331.00	Seat height 17" - 22"
	Tension knob	Grade 6 / Grade-in D	\$1,356.00	Travel range (ht.) 4" (back) / 5" (seat)
	Seat tilting			COM 1.5 yds.
	Seat depth adjustment			Carton / FedEx wt 63 lbs / 195 lbs
	Heavy-duty structure			Arms Group 1* & 4
	Dual-tone universal soft casters			*no KR23, KR23-45, KR23-65
TLC seat			Warranty 7 year limited	



Model	Description	Textile Grade-In*	List	Specifications
<b>IU79PD</b> (aka, PT79PD)	<i>Simple Multi-Function (-7HD)</i>	Grade 1 / C.O.M.	\$1,301.00	Overall width 28"
	Pneumatic lift	Grade 2	\$1,326.00	Overall height 46.5" - 54.5"
	Tilting backrest	Grade 3 / Grade-in A	\$1,351.00	Back 19.5" w x 28" h
	EZ back height adjustment	Grade 4 / Grade-in B	\$1,376.00	Seat 22" w x 18-21.1" d
	Rocking tilt			Seat height 17" - 22"
	Tension knob			Travel range (ht.) 4" (back) / 5" (seat)
	Seat tilting			COM 1.5 yds.
	Seat depth adjustment			Carton / FedEx wt 63 lbs / 195 lbs
	Heavy-duty structure			Arms Group 1* & 4
	Lower back reinforced with ballistic nylon			*no KR23, KR23-45, KR23-65
Dual-tone universal soft casters			Warranty 7 year limited	
TLC seat				



Above weights do not include optional arm kits. ; FedEx weight is calculated using FedEx dimensional standards to determine billable weight. ; Pricing and specifications subject to change without notification.



# Intensive Use 24-7 (IUHD/PD)

(IUHD/PD | to be renamed "PTHD/PTPD" in 2024)

Heavy-duty

Please see pages 189 – 207 for arm kits, casters, and other options.

stools

Model	Description	Textile Grade-In	List	Specifications
<b>IU77HD</b> (aka, PT77HD)	<i>Simple Multi-Function (-7HD)</i>	Grade 1 / C.O.M.	\$1,222.00	Overall width 28"
	Pneumatic lift with 8" cylinder only	Grade 2 / Grade-in A	\$1,242.00	Overall height 45" - 57"
	EZ back height adjustment	Grade 3 / Grade-in B	\$1,262.00	Back 19.5" w x 22" h
	Independent seat and back angle adjustment	Grade 4 / Grade-in C	\$1,282.00	Seat 22" w x 18-21.1" d
	Tension knob	Grade 5 / Grade-in D	\$1,302.00	Seat height 22" - 30"
	Turn-Lock footring	Grade 6 / Grade-in E	\$1,322.00	Travel range (ht.) 4" (back) / 8" (seat)
	Seat depth adjustment			COM 1.5 yds.
	20" chrome footring			Carton / FedEx wt 63 lbs / 101 lbs
	Heavy-duty structure			Arms Group 1* & 4
	Dual-tone universal soft casters			*no KR23, KR23-45, KR23-65
TLC seat			Warranty 7 year limited	



350 POUNDS CAPACITY

TLC TECHNOLOGY

Model	Description	Textile Grade-In*	List	Specifications
<b>IU77PD</b> (aka, PT77PD)	<i>Simple Multi-Function (-7HD)</i>	Grade 1 / C.O.M.	\$1,292.00	Overall width 28"
	Pneumatic lift with 8" cylinder only	Grade 2 / Grade-in A	\$1,317.00	Overall height 45" - 57"
	EZ back height adjustment	Grade 3 / Grade-in B	\$1,342.00	Back 19.5" w x 22" h
	Independent seat and back angle adjustment	Grade 4 / Grade-in C	\$1,367.00	Seat 22" w x 18-21.1" d
	Tension knob			Seat height 22" - 30"
	Turn-Lock footring			Travel range (ht.) 4" (back) / 8" (seat)
	Seat depth adjustment			COM 1.5 yds.
	20" chrome footring			Carton / FedEx wt 63 lbs / 101 lbs
	Heavy-duty structure			Arms Group 1* & 4
	Lower back reinforced with ballistic nylon			*no KR23, KR23-45, KR23-65
Dual-tone oversized soft caster			Warranty 7 year limited	
TLC seat				



350 POUNDS CAPACITY

TLC TECHNOLOGY

common options

### Suggested Options for IUHD/IUPD Series

Arms		
	<b>JRBN (1D Motion)</b> - list: 267.00 Fixed width T-arms with fold back feature and trigger-style height control with ballistic nylon upholstered arm pads.	
	<b>JRPD (1D Motion)</b> - list: 267.00 Fixed width T-arms with fold back feature and trigger-style height control with Memosoft arm pads.	
	<b>JR69 (4D Motion)</b> - list: 196.00 Height and width adjustable, forward slanting T-arm with soft touch width adjustment trigger, lockable arm top, fore-aft, side-side, pivoting arm top (RP-65).	<b>6GSPC</b> Alternate stool base option for IU77HD/PD – no upcharge to substitute. The default cylinder is CYL-6SHD. Seat height range is 25.5" – 31.5"

For specs and warranty, see page 191.

For specs and warranty, see page 194.

Intensive Use 24-Seven Heavy-Duty Series designed to accommodate users up to 350 pounds.

IU: Intensive Use (aka, 24/7 environments)

HD: Heavy-Duty (i.e. for occupants weighing up to 350 lbs.)

PD: Police Department (i.e., perfect for police or security environments)

\*Application testing may be required for Grade-In fabrics on IUPD and MXPD seating. Consult OM for details.

Above weights do not include optional arm kits. ; FedEx weight is calculated using FedEx dimensional standards to determine billable weight. ; Pricing and specifications subject to change without notification.



# Lórien®

## Features:

- Begins +\$822 armless / \$877 with Cantilever arms (Lórien Mid-back (LN5-4BK01-C-Tb))
- Elegantly simple, meet and collaborate with confidence
- Mid- or high-back, available in Modern Black or Cloud White frame with complementary mesh/frame color pairings
- Shadow Grey Suspension fabric mesh offers a still-breathable, but warmer look & feel than full mesh
- For enhanced comfort, add an optional seat pad
- Designed by Fiorenzo Dorigo







# Lórien® Mid-back Mesh (LN5-)

Conference | Executive | Office





### Lórien Core Features:

- All Mesh Mid-back
- Multi-surface Casters
- 300 lb. Weight Capacity
- 12 year Limited Warranty

**Note:** Green font color indicates default build for "most popular" configuration of this spread.

1. Model		2. Back, Frame and Mesh Finish		3. Arms		4. Mechanism	
Code	List	Code	List	Code	List	Code	List
<b>LN5-</b>	<b>\$822</b>	<b>-4BK01</b> Modern Black frame with black mesh	<b>\$0</b>	<b>-N</b> (No arms)	<b>\$0</b>	<b>-Tb</b> <b>Simple Tilt Conference</b> • Height adjustable • Simple rocking tilt w/ upright position lock out	<b>\$0</b>
		<b>-4BK01-SG</b> Modern Black frame with <b>Shadow Grey Suspension Fabric</b> (breathable, mesh alt.)	<b>+\$45</b>	 <b>-C</b> <b>Cantilever Arm</b> • Matches frame color	<b>+\$55</b>	<b>-KTa</b> <b>Executive Knee Tilt</b> • Height adjustable • Tilt adjustment • 4 position tilt lock	<b>+\$15</b>
		<b>-4WT04</b> Cloud White frame with grey mesh	<b>+\$45</b>	 <b>-L</b> <b>Loop Arm</b> • Matches frame color	<b>+\$55</b>		
		<b>-4WT04-SG</b> Cloud White frame with <b>Shadow Grey Suspension Fabric</b> (breathable, mesh alt.)	<b>+\$90</b>				

### OTHER OPTIONS (append to above nomenclature to add to, or override existing options)

Casters and Glides		List	Seat Pad Upholstery Option	
			Code	List
	<b>-GLDR</b> Glides	<b>\$0</b>	<b>• Grade 1 / C.O.M.</b>	<b>\$89</b>
	<b>-65MS</b> 65mm Grey two-tone multi-surface soft caster	<b>+\$25</b>	<b>• Grade 2 / Grade-in A</b>	<b>+\$104</b>
	<b>-50SS</b> 50mm safety soft casters, minimizes chair movement when <b>NOT</b> in use	<b>+\$25</b>	<b>• Grade 3 / Grade-in B</b>	<b>+\$119</b>
	<b>-50R</b> 50mm reverse braking caster, restricts chair movement when chair <b>IS</b> in use	<b>+\$35</b>	<b>• Grade 4 / Grade-in C</b>	<b>+\$134</b>
			<b>• Grade 5 / Grade-in D</b>	<b>+\$149</b>
			<b>• Grade 6 / Grade-in E</b>	<b>+\$164</b>
			<b>• LG1 Evita / C.O.L.</b>	<b>+\$224</b>
			<b>• LG2 Lena - LDEL, LLUT, LORC only*</b>	<b>+\$239</b>
			<b>• LG3 Vulcano - LMIT, LSTG only*</b>	<b>+\$244</b>

\*For NON In-Stock colors, check with OM Seating for additional pricing details.

## MODEL CODE

Example: LN5 - 4BK01 - C - Tb - STDB

Model #    Finish    Arm    Mech.    Base pkg.

5. Base Packages (includes cylinder, base and casters)	
Code	List
Low Seat Height Packages	
<b>-XSB</b> <b>Low Seat Height Package (Black)</b> Seat height: 16" - 21" (w/-Tb) / 15.5" - 19" (w/-KTa) • <b>Cylinder:</b> 5" Black (5BCE w/-Tb) / 4" black (4BCE w/-KTa) • <b>Base:</b> 28" Black nylon (28NCE) • <b>Casters:</b> 55mm Black two-tone multi-surface (55MSB)	<b>+\$20</b>
<b>-XSP</b> <b>Low Seat Height Package (Polished)</b> Seat height: 16" - 21" (w/-Tb) / 15.5" - 19" (w/-KTa) • <b>Cylinder:</b> 5" Chrome (5CCE w/-Tb) / 4" chrome (4CCE w/-KTa) • <b>Base:</b> 28" Polished aluminum (28PCE) • <b>Casters:</b> 55mm Quiet Stem black two-tone multi-surface (55QMSB)	<b>+\$110</b>
Standard Seat Height Packages	
<b>-STDB</b> <b>Standard Seat Height Package (Black)</b> Seat height: 17" - 22" • <b>Cylinder:</b> 5" Black (5BWY w/-Tb) / (5BCE w/-KTa) • <b>Base:</b> 28" Black nylon (28NCE) • <b>Casters:</b> 55mm Black two-tone multi-surface (55MSB)	<b>+\$0</b>
<b>-STDP</b> <b>Standard Seat Height Package (Polished)</b> Seat height: 17" - 22" • <b>Cylinder:</b> 5" Chrome (5CR w/-Tb) / (5CCE w/-KTa) • <b>Base:</b> 28" Polished aluminum (28PCE) • <b>Casters:</b> 55mm Quiet Stem black two-tone multi-surface (55QMSB)	<b>+\$90</b>
High Seat Height Packages	
<b>-HIB</b> <b>High Seat Height Package (Black)</b> Seat height: 18.5" - 24.5" (w/-Tb) / 19" - 23.5" (w/-KTa) • <b>Cylinder:</b> 6" Black (6BSHD w/-Tb) / 5" black (5BWY w/-KTa) • <b>Base:</b> 28" Black nylon (28NCE) • <b>Casters:</b> 55mm Black two-tone multi-surface (55MSB)	<b>+\$40</b>
<b>-HIP</b> <b>High Seat Height Package (Polished)</b> Seat height: 18.5" - 24.5" (w/-Tb) / 19" - 23.5" (w/-KTa) • <b>Cylinder:</b> 6" Chrome (6CHD w/-Tb) / 5" chrome (5CR w/-KTa) • <b>Base:</b> 28" Polished aluminum (28PCE) • <b>Casters:</b> 55mm Quiet Stem black two-tone multi-surface (55QMSB)	<b>+\$130</b>

\* For even more options, please refer to penultimate page of this price guide.

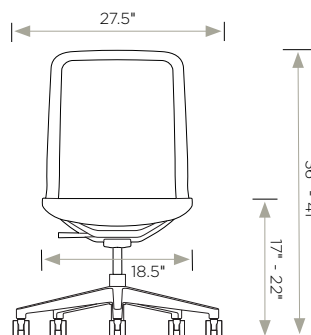

Dimensions	W	D	H
Overall	27.5"	27.5"	36" - 41"
Seat	18.5"	18.5"	17" - 22"
Back	18"	N/A	21"

Travel Range (height)	N/A	5" seat
Upholstery	Seat	Back
COM	1.0 yd	N/A
Shipping	Carton Wt.	FedEx Wt.
	27 lbs.	65 lbs.





# Lórien® High back Mesh (LN5-)

Conference | Executive | Office





### Lórien Core Features:

- All Mesh High back
- Multi-surface Casters
- 300 lb. Weight Capacity
- 12 year Limited Warranty

**Note:** Green font color indicates default build for "most popular" configuration of this spread.

1. Model		2. Back, Frame and Mesh Finish		3. Arms		4. Mechanism		
Code	List	Code	List	Code	List	Code	List	
<b>LN5-</b>	<b>\$862</b>	<b>-8BK01</b> Modern Black frame with black mesh	<b>\$0</b>		<b>-N</b> (No arms)	<b>\$0</b>	<b>-Tb</b> <b>Simple Tilt Conference</b> • Height adjustable • Simple rocking tilt w/ upright position lock out	<b>+\$0</b>
		<b>-8BK01-SG</b> Modern Black frame with <b>Shadow Grey Suspension Fabric</b> (breathable, mesh alt.)	<b>+\$45</b>		<b>-C</b> <b>Cantilever Arm</b> • Matches frame color	<b>+\$55</b>		
		<b>-8WT04</b> Cloud White frame with grey mesh	<b>+\$45</b>		<b>-L</b> <b>Loop Arm</b> • Matches frame color	<b>+\$55</b>		
		<b>-8WT04-SG</b> Cloud White frame with <b>Shadow Grey Suspension Fabric</b> (breathable, mesh alt.)	<b>+\$90</b>				<b>-KTa</b> <b>Executive Knee Tilt</b> • Height adjustable • Tilt adjustment • 4 position tilt lock	<b>+\$15</b>

### OTHER OPTIONS (append to above nomenclature to add to, or override existing options)

Casters and Glides		List	Seat Pad Upholstery Option	
			Code	List
	<b>-GLDR</b> Glides	<b>\$0</b>		
	<b>-65MS</b> 65mm Grey two-tone multi-surface soft caster	<b>+\$25</b>	• <b>Grade 1 / C.O.M.</b>	<b>\$89</b>
	<b>-50SS</b> 50mm safety soft casters, minimizes chair movement when <b>NOT</b> in use	<b>+\$25</b>	• <b>Grade 2 / Grade-in A</b>	<b>+\$104</b>
	<b>-50R</b> 50mm reverse braking caster, restricts chair movement when chair <b>IS</b> in use	<b>+\$35</b>	• <b>Grade 3 / Grade-in B</b>	<b>+\$119</b>
			• <b>Grade 4 / Grade-in C</b>	<b>+\$134</b>
			• <b>Grade 5 / Grade-in D</b>	<b>+\$149</b>
			• <b>Grade 6 / Grade-in E</b>	<b>+\$164</b>
			• <b>LG1 Evita / C.O.L.</b>	<b>+\$224</b>
			• <b>LG2 Lena - LDEL, LLUT, LORC only*</b>	<b>+\$239</b>
			• <b>LG3 Vulcano - LMIT, LSTG only*</b>	<b>+\$244</b>

\*For NON In-Stock colors, check with OM Seating for additional pricing details.

## MODEL CODE

Example: LN5 - 8BK01 - C - Tb - STDB

Model #    Finish    Arm    Mech.    Base pkg.

5. Base Packages (includes cylinder, base and casters)	
Code	List
Low Seat Height Packages	
<b>-XSB</b> <b>Low Seat Height Package (Black)</b> Seat height: 16" - 21" (w/-Tb) / 15.5" - 19" (w/-KTa) • <b>Cylinder:</b> 5" Black (5BCE w/-Tb) / 4" black (4BCE w/-KTa) • <b>Base:</b> 28" Black nylon (28NCE) • <b>Casters:</b> 55mm Black two-tone multi-surface (55MSB)	<b>+\$20</b>
<b>-XSP</b> <b>Low Seat Height Package (Polished)</b> Seat height: 16" - 21" (w/-Tb) / 15.5" - 19" (w/-KTa) • <b>Cylinder:</b> 5" Chrome (5CCE w/-Tb) / 4" chrome (4CCE w/-KTa) • <b>Base:</b> 28" Polished aluminum (28PCE) • <b>Casters:</b> 55mm Quiet Stem black two-tone multi-surface (55QMSB)	<b>+\$110</b>
Standard Seat Height Packages	
<b>-STDB</b> <b>Standard Seat Height Package (Black)</b> Seat height: 17" - 22" • <b>Cylinder:</b> 5" Black (5BWY w/-Tb) / (5BCE w/-KTa) • <b>Base:</b> 28" Black nylon (28NCE) • <b>Casters:</b> 55mm Black two-tone multi-surface (55MSB)	<b>+\$0</b>
<b>-STDP</b> <b>Standard Seat Height Package (Polished)</b> Seat height: 17" - 22" • <b>Cylinder:</b> 5" Chrome (5CR w/-Tb) / (5CCE w/-KTa) • <b>Base:</b> 28" Polished aluminum (28PCE) • <b>Casters:</b> 55mm Quiet Stem black two-tone multi-surface (55QMSB)	<b>+\$90</b>
High Seat Height Packages	
<b>-HIB</b> <b>High Seat Height Package (Black)</b> Seat height: 18.5" - 24.5" (w/-Tb) / 19" - 23.5" (w/-KTa) • <b>Cylinder:</b> 6" Black (6BSHD w/-Tb) / 5" black (5BWY w/-KTa) • <b>Base:</b> 28" Black nylon (28NCE) • <b>Casters:</b> 55mm Black two-tone multi-surface (55MSB)	<b>+\$40</b>
<b>-HIP</b> <b>High Seat Height Package (Polished)</b> Seat height: 18.5" - 24.5" (w/-Tb) / 19" - 23.5" (w/-KTa) • <b>Cylinder:</b> 6" Chrome (6CHD w/-Tb) / 5" chrome (5CR w/-KTa) • <b>Base:</b> 28" Polished aluminum (28PCE) • <b>Casters:</b> 55mm Quiet Stem black two-tone multi-surface (55QMSB)	<b>+\$130</b>

\* For even more options, please refer to penultimate page of this price guide.

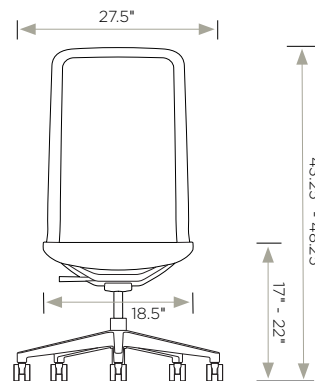

Dimensions	W	D	H
Overall	27.5"	27.5"	43.25" - 48.25"
Seat	18.5"	18.5"	17" - 22"
Back	18"	N/A	27"

<b>Travel Range (height)</b>	N/A	5" seat
<b>Upholstery</b>	<b>Seat</b>	<b>Back</b>
COM	1.0 yd	N/A
<b>Shipping</b>	<b>Carton Wt.</b>	<b>FedEx Wt.</b>
	34 lbs.	65 lbs.





# Lórien® Mid-back Mesh Task Stool (LN5-TS)

Workstations | Coworking | Office





### Lórien Core Features:

- All Mesh Mid-back Task Stool
- Multi-surface Casters
- 300 lb. Weight Capacity
- 12 year Limited Warranty

**Note:** Green font color indicates default build for "most popular" configuration of this spread.

1. Model		2. Back, Frame and Mesh Finish		3. Arms		4. Mechanism	
Code	List	Code	List	Code	List	Code	List
<b>LN5-TS</b>	<b>\$918</b>	21" Mid-Back		-N (No arms)	<b>\$0</b>	-Tb <b>Simple Tilt Conference</b>	<b>+\$0</b>
		-4BK01 Modern Black frame with black mesh	<b>\$0</b>	 -C <b>Cantilever Arm</b> • Matches frame color	<b>+\$55</b>	• Height adjustable	
		-4BK01-SG Modern Black frame with <b>Shadow Grey Suspension Fabric</b> (breathable, mesh alt.)	<b>+\$45</b>	 -L <b>Loop Arm</b> • Matches frame color	<b>+\$55</b>	• Simple rocking tilt w/ upright position lock out	
		-4WT04 Cloud White frame with grey mesh	<b>+\$45</b>				
		-4WT04-SG Cloud White frame with <b>Shadow Grey Suspension Fabric</b> (breathable, mesh alt.)	<b>+\$90</b>				

### OTHER OPTIONS (append to above nomenclature to add to, or override existing options)

Casters and Glides		List	Seat Pad Upholstery Option	
			Code	List
	-GLDR Glides	<b>\$0</b>	• Grade 1 / C.O.M.	<b>\$89</b>
	-65MS 65mm Grey two-tone multi-surface soft caster	<b>+\$25</b>	• Grade 2 / Grade-in A	<b>+\$104</b>
	-5OSS 50mm safety soft casters, minimizes chair movement when <b>NOT</b> in use	<b>+\$25</b>	• Grade 3 / Grade-in B	<b>+\$119</b>
	-5OR 50mm reverse braking caster, restricts chair movement when chair <b>IS</b> in use	<b>+\$35</b>	• Grade 4 / Grade-in C	<b>+\$134</b>
			• Grade 5 / Grade-in D	<b>+\$149</b>
			• Grade 6 / Grade-in E	<b>+\$164</b>
			• LG1 Evita / C.O.L.	<b>+\$224</b>
			• LG2 Lena - LDEL, LLUT, LORC only*	<b>+\$239</b>
			• LG3 Vulcano - LMIT, LSTG only*	<b>+\$244</b>

\*For NON In-Stock colors, check with OM Seating for additional pricing details.



**MODEL CODE**

Example: LN5-TS - 4BK01 - C - Tb - 8TLB  
 Model #      Finish      Arm      Mech.      Base pkg.

5. Base Packages (includes cylinder, base and casters)	
Code	List
Counter Height Base Packages	
<b>-8TLB</b> <b>Counter Height Stool Package with Adjustable Footring (Black)</b> Seat height: 20" - 28" • <b>Cylinder:</b> 8" Black (8BAT) • <b>Base:</b> 28" Black nylon (28NCE) • <b>Casters:</b> 55mm Black two-tone multi-surface (55MSB)	<b>+\$0</b>
<b>-8TLP</b> <b>Counter Height Stool Package with Adjustable Footring (Polished)</b> Seat height: 20" - 28" • <b>Cylinder:</b> 8" Chrome (8CHD) • <b>Base:</b> 28" Polished aluminum (28PCE) • <b>Casters:</b> 55mm Quiet Stem black two-tone multi-surface (55QMSB)	<b>\$90</b>
Bar Height Base Packages	
<b>-10TLB</b> <b>Bar Height Stool Package with Adjustable Footring (Black)</b> Seat height: 24" - 34" • <b>Cylinder:</b> 10" Chrome (10CHD) • <b>Base:</b> 28" Black nylon (28NCE) • <b>Casters:</b> 55mm Black two-tone multi-surface (55MSB)	<b>+\$10</b>
<b>-10TLP</b> <b>Bar Height Stool Package with Adjustable Footring (Polished)</b> Seat height: 24" - 34" • <b>Cylinder:</b> 10" Chrome (10CHD) • <b>Base:</b> 28" Polished aluminum (28PCE) • <b>Casters:</b> 55mm Quiet Stem black two-tone multi-surface (55QMSB)	<b>+\$100</b>

\* For even more options, please refer to penultimate page of this price guide.

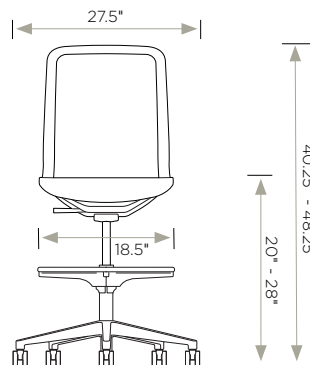

Dimensions	W	D	H
Overall (8" cylinder)	27.5"	27.5"	40.25" - 48.25"
Seat	18.5"	18.5"	20" - 28"
Back	18"	N/A	21"

<b>Travel Range (height)</b>	N/A	8" seat
<b>Upholstery</b>	<b>Seat</b>	<b>Back</b>
COM	1.0 yd	N/A
<b>Shipping</b>	<b>Carton Wt.</b>	<b>FedEx Wt.</b>
	34 lbs.	65 lbs.





# Lórien® Mid-back Mesh 4-Star (LN5-4S)

Guest Seating | Visitor | Conference

### Lórien Core Features:

- All Mesh Mid-back 4-star Guest Chair
- 300 lb. Weight Capacity
- 12 year Limited Warranty

**Note:** Green font color indicates default build for "most popular" configuration of this spread.

1. Model		2. Back, Frame and Mesh Finish		3. Arms		4. Mechanism	
Code	List	Code	List	Code	List	Code	List
<b>LN5-4S</b>	<b>\$847</b>	21" Mid-Back		-N (No arms)	<b>\$0</b>	-Tb <b>Simple Tilt Conference</b>	<b>+\$0</b>
		-4BK01 Modern Black frame with black mesh	<b>\$0</b>	 -C <b>Cantilever Arm</b> • Matches frame color	<b>+\$55</b>	• Height adjustable	
		-4BK01-SG Modern Black frame with <b>Shadow Grey Suspension Fabric</b> (breathable, mesh alt.)	<b>+\$45</b>	 -L <b>Loop Arm</b> • Matches frame color	<b>+\$55</b>	• Simple rocking tilt w/ upright position lock out	
		-4WTO4 Cloud White frame with grey mesh	<b>+\$45</b>				
		-4WTO4-SG Cloud White frame with <b>Shadow Grey Suspension Fabric</b> (breathable, mesh alt.)	<b>+\$90</b>				

### OTHER OPTIONS (append to above nomenclature to add to, or override existing options)

Seat Pad Upholstery Option	
Code	List
• <b>Grade 1 / C.O.M.</b>	<b>\$89</b>
• <b>Grade 2 / Grade-in A</b>	<b>+\$104</b>
• <b>Grade 3 / Grade-in B</b>	<b>+\$119</b>
• <b>Grade 4 / Grade-in C</b>	<b>+\$134</b>
• <b>Grade 5 / Grade-in D</b>	<b>+\$149</b>
• <b>Grade 6 / Grade-in E</b>	<b>+\$164</b>
• <b>LG1 Evita / C.O.L.</b>	<b>+\$224</b>
• <b>LG2 Lena - LDEL, LLUT, LORC only*</b>	<b>+\$239</b>
• <b>LG3 Vulcano - LMIT, LSTG only*</b>	<b>+\$244</b>

\*For NON In-Stock colors, check with OM Seating for additional pricing details.

## MODEL CODE

Example: LN5-4S - 4BK01 - C - Tb - STDB  
 Model #      Finish      Arm      Mech.      Base pkg.

5. Base Packages (includes cylinder, base and casters)	
Code	List
Standard Seat Height Packages	
<b>-STDB</b> <b>Standard Seat Height Package (Black)</b> Seat height: 16.5" - 20.5" • <b>Cylinder:</b> 4" Black (4BCE) • <b>Base:</b> 27" Black 4-star (27BL4) • <b>Glides:</b> Black nylon	+\$0
<b>-STDP</b> <b>Standard Seat Height Package (Polished)</b> Seat height: 16.5" - 20.5" • <b>Cylinder:</b> 4" Chrome (4CCE) • <b>Base:</b> 27" Polished aluminum 4-star (27PL4) • <b>Glides:</b> Black nylon	+\$65
Fixed Height Base Packages	
<b>-FHB</b> <b>Fixed Height Package (Black)</b> Seat height: 18.5" • <b>Cylinder:</b> Black (5BCEF) • <b>Base:</b> 27" Black 4-star (27BL4) • <b>Glides:</b> Black nylon	+\$15
<b>-FHP</b> <b>Fixed Height Package (Polished)</b> Seat height: 18.5" • <b>Cylinder:</b> Chrome (5CCEF) • <b>Base:</b> 27" Polished aluminum 4-star (27PL4) • <b>Glides:</b> Black nylon	+\$80

\* For even more options, please refer to penultimate page of this price guide.

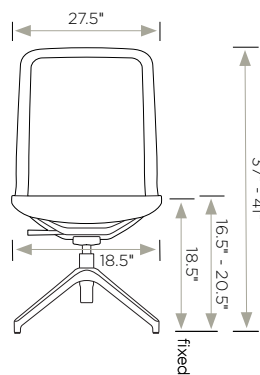

Dimensions	W	D	H
Overall	27.5"	27.5"	37" - 41"
Seat	18.5"	18.5"	16.5" - 20.5"
Back	18"	N/A	21"

<b>Travel Range (height)</b>	N/A	4" seat
<b>Upholstery</b>	<b>Seat</b>	<b>Back</b>
COM	1.0 yd	N/A
<b>Shipping</b>	<b>Carton Wt.</b>	<b>FedEx Wt.</b>
	27 lbs.	65 lbs.



# Maxwell IU

## Features:

- Begins @ \$1,290 armless / \$1,409 with KR200 arms (MX84IU)
- Our heaviest chair both by weight and weight-rating is scaled and built to comfortably support up to 450 lbs.
- Relatively slim backrest design has a useful trapezoidal shape that creates less exaggerated aesthetics
- 24" wide seat, steel seat plate & extra heavy-duty components make this a strong choice





# Maxwell (MXIU/PD)

Multi-shift | Heavy-duty

Please see pages 189 – 207 for arm kits, casters, and other options.

average / medium

Model	Description	Textile Grade-In	List	Specifications
<b>MX84IU</b> 	<i>Simple Multi-Function (-7MX)</i>	Grade 1 / C.O.M.	\$1,290.00	Overall width 28"
	Pneumatic lift	Grade 2	\$1,315.00	Overall height 38" - 47"
	Tilting backrest	Grade 3 / Grade-in A	\$1,340.00	Back 23.5" w x 20" h
	EZ back height adjustment	Grade 4 / Grade-in B	\$1,365.00	Seat 24" w x 18-20.5" d
	Rocking tilt	Grade 5 / Grade-in C	\$1,390.00	Seat height 18" - 23"
	Tension knob	Grade 6 / Grade-in D	\$1,415.00	Travel range (ht.) 4" (back) / 5" (seat)
	Fabric panel back			COM 1.5 yds.
	Trim wide-back design			Carton / FedEx wt 63 lbs / 195 lbs
	Seat depth adjustment			Arms Group 1* (no ETR1)
	Dual-tone universal soft casters			*no KR23, KR23-45, KR23-65
			Warranty 7 year limited	

Model	Description	Textile Grade-In *	List	Specifications
<b>MX84PD</b> 	<i>Simple Multi-Function (-7MX)</i>	Grade 1 / C.O.M.	\$1,360.00	Overall width 28"
	Pneumatic lift	Grade 2	\$1,385.00	Overall height 38" - 47"
	Tilting backrest	Grade 3 / Grade-in A	\$1,410.00	Back 23.5" w x 20" h
	EZ back height adjustment	Grade 4 / Grade-in B	\$1,435.00	Seat 24" w x 18-20.5" d
	Rocking tilt			Seat height 18" - 23"
	Tension knob			Travel range (ht.) 4" (back) / 5" (seat)
	Fabric panel back (Ballistic Nylon)			COM 1.5 yds.
	Trim wide-back design			Carton / FedEx wt 63 lbs / 195 lbs
	Lower back (Ballistic Nylon)			Arms Group 1* (no ETR1)
	Seat depth adjustment			*no KR23, KR23-45, KR23-65
Dual-tone universal soft casters			Warranty 7 year limited	

large / xtra tall

Model	Description	Textile Grade-In	List	Specifications
<b>MX88IU</b> 	<i>Simple Multi-Function (-7MX)</i>	Grade 1 / C.O.M.	\$1,362.00	Overall width 28"
	Pneumatic lift	Grade 2	\$1,387.00	Overall height 43" - 52"
	Tilting backrest	Grade 3 / Grade-in A	\$1,412.00	Back 23.5" w x 25" h
	EZ back height adjustment	Grade 4 / Grade-in B	\$1,437.00	Seat 24" w x 18-20.5" d
	Rocking tilt	Grade 5 / Grade-in C	\$1,462.00	Seat height 18" - 23"
	Tension knob	Grade 6 / Grade-in D	\$1,487.00	Travel range (ht.) 4" (back) / 5" (seat)
	Fabric panel back			COM 2 yds.
	Trim wide-back design			Carton / FedEx wt 68 lbs / 195 lbs
	Seat depth adjustment			Arms Group 1* (no ETR1)
	Dual-tone universal soft casters			*no KR23, KR23-45, KR23-65
			Warranty 7 year limited	

Model	Description	Textile Grade-In*	List	Specifications
<b>MX88PD</b> 	<i>Simple Multi-Function (-7MX)</i>	Grade 1 / C.O.M.	\$1,432.00	Overall width 28"
	Pneumatic lift	Grade 2	\$1,457.00	Overall height 43" - 52"
	Tilting backrest	Grade 3 / Grade-in A	\$1,482.00	Back 23.5" w x 25" h
	EZ back height adjustment	Grade 4 / Grade-in B	\$1,507.00	Seat 24" w x 18-20.5" d
	Rocking tilt			Seat height 18" - 23"
	Tension knob			Travel range (ht.) 4" (back) / 5" (seat)
	Fabric panel back (Ballistic Nylon)			COM 2 yds.
	Trim wide-back design			Carton / FedEx wt 68 lbs / 195 lbs
	Lower back (Ballistic Nylon)			Arms Group 1* (no ETR1)
	Seat depth adjustment			*no KR23, KR23-45, KR23-65
Dual-tone universal soft casters			Warranty 7 year limited	

**NOTES:**

\*If purchasing arms separate (as a retrofit option), use special, heavier-duty bolts. Arms should normally be installed by OM or its authorized dealers.

Models designated as "FedEx Ground oversized" may incur additional charges when shipped via FedEx. Contact OM for pricing and details.

Above weights do not include optional arm kits. ∴ FedEx weight is calculated using FedEx dimensional standards to determine billable weight. ∴ Pricing and specifications subject to change without notification.

\*Application testing may be required for Grade-In fabrics on IUPD and MXPD seating. Consult OM for details.

**MX: Max Heavy-Duty (i.e., users up to 450 lbs.)**  
**PD: Police Department (i.e., perfect for police or security environments)**

# Maxwell (MXIU/PD)

Multi-shift | Heavy-duty

Please see pages 189 – 207 for arm kits, casters, and other options.

variations & stools

Model	Description	Textile Grade-In	List	Specifications
<b>MX85IU</b>  <p><b>FedEx</b> Ground oversize</p> <p><b>450</b> POUNDS CAPACITY</p>	<i>Simple Multi-Function (-7MX)</i>	Grade 1 / C.O.M.	\$1,447.00	Overall width 32"
	Pneumatic lift	Grade 2	\$1,472.00	Overall height 49.5" - 59.5"
	Tilting backrest	Grade 3 / Grade-in A	\$1,497.00	Back 23.5" w x 20" h
	EZ back height adjustment	Grade 4 / Grade-in B	\$1,522.00	Seat 24" w x 18-20.5" d
	Rocking tilt	Grade 5 / Grade-in C	\$1,547.00	Seat height 28" - 34.5"
	Tension knob	Grade 6 / Grade-in D	\$1,572.00	Travel range (ht.) 4" (back) / 6.5" (seat)
	Fabric panel back			COM 1.5 yds.
	Trim wide-back design			Carton weight 57 lbs (box 1) / 18.2 lbs (box 2)
	Seat depth adjustment			FedEx weight 195 lbs (box 1) / 59 lbs (box 2)
	<i>Oversize Grande Spider Package</i>			Arms Group 1* (no ETR1)
	<i>6" Super HD cylinder and glides</i>			*no KR23, KR23-45, KR23-65
	<i>(upcharge for casters)</i>			Warranty 7 year limited

Model	Description	Textile Grade-In*	List	Specifications
<b>MX85PD</b>  <p><b>FedEx</b> Ground oversize</p> <p><b>450</b> POUNDS CAPACITY</p>	<i>Simple Multi-Function (-7MX)</i>	Grade 1 / C.O.M.	\$1,517.00	Overall width 32"
	Pneumatic lift	Grade 2	\$1,542.00	Overall height 49.5" - 59.5"
	Tilting backrest	Grade 3 / Grade-in A	\$1,567.00	Back 23.5" w x 20" h
	EZ back height adjustment	Grade 4 / Grade-in B	\$1,592.00	Seat 24" w x 18-20.5" d
	Rocking tilt			Seat height 28" - 34.5"
	Tension knob			Travel range (ht.) 4" (back) / 6.5" (seat)
	Fabric panel back (Ballistic Nylon)			COM 1.5 yds.
	Lower back (Ballistic Nylon)			Carton weight 57 lbs (box 1) / 18.2 lbs (box 2)
	Seat depth adjustment			FedEx weight 195 lbs (box 1) / 59 lbs (box 2)
	<i>Oversize Grande Spider Package</i>			Arms Group 1* (no ETR1)
	<i>6" Super HD cylinder and glides</i>			*no KR23, KR23-45, KR23-65
	<i>(upcharge for casters)</i>			Warranty 7 year limited

\*JR-BN arms (shown here) are not included in list pricing.

Model	Description	Textile Grade-In	List	Specifications
<b>MX87IU</b>  <p><b>FedEx</b> Ground oversize</p> <p><b>450</b> POUNDS CAPACITY</p>	<i>Simple Multi-Function (-7MX)</i>	Grade 1 / C.O.M.	\$1,519.00	Overall width 32"
	Pneumatic lift	Grade 2	\$1,544.00	Overall height 54.5" - 64.5"
	Tilting backrest	Grade 3 / Grade-in A	\$1,569.00	Back 23.5" w x 25" h
	EZ back height adjustment	Grade 4 / Grade-in B	\$1,594.00	Seat 24" w x 18-20.5" d
	Rocking tilt	Grade 5 / Grade-in C	\$1,619.00	Seat height 28" - 34.5"
	Tension knob	Grade 6 / Grade-in D	\$1,644.00	Travel range (ht.) 4" (back) / 6.5" (seat)
	Fabric panel back			COM 2 yds.
	Trim wide-back design			Carton weight 62 lbs (box 1) / 18.2 lbs (box 2)
	Seat depth adjustment			FedEx weight 195 lbs (box 1) / 59 lbs (box 2)
	<i>Oversize Grande Spider Package</i>			Arms Group 1* (no ETR1)
	<i>6" Super HD cylinder and glides</i>			*no KR23, KR23-45, KR23-65
	<i>(upcharge for casters)</i>			Warranty 7 year limited

Model	Description	Textile Grade-In*	List	Specifications
<b>MX87PD</b>  <p><b>FedEx</b> Ground oversize</p> <p><b>450</b> POUNDS CAPACITY</p>	<i>Simple Multi-Function (-7MX)</i>	Grade 1 / C.O.M.	\$1,589.00	Overall width 32"
	Pneumatic lift	Grade 2	\$1,614.00	Overall height 54.5" - 64.5"
	Tilting backrest	Grade 3 / Grade-in A	\$1,639.00	Back 23.5" w x 25" h
	EZ back height adjustment	Grade 4 / Grade-in B	\$1,664.00	Seat 24" w x 18-20.5" d
	Rocking tilt			Seat height 28" - 34.5"
	Tension knob			Travel range (ht.) 4" (back) / 6.5" (seat)
	Fabric panel back (Ballistic Nylon)			COM 2 yds.
	Lower back (Ballistic Nylon)			Carton weight 62 lbs (box 1) / 18.2 lbs (box 2)
	Seat depth adjustment			FedEx weight 195 lbs (box 1) / 59 lbs (box 2)
	<i>Oversize Grande Spider Package</i>			Arms Group 1* (no ETR1)
	<i>6" Super HD cylinder and glides</i>			*no KR23, KR23-45, KR23-65
	<i>(upcharge for casters)</i>			Warranty 7 year limited

\*JR-BN arms (shown here) are not included in list pricing.

**NOTES:**  
MXIU/PD stools normally ship in 2 boxes per 1 stool.

\*Application testing may be required for Grade-in fabrics on IUPD and MXPD seating. Consult OM for details.

Glides recommended instead of casters on MXIU stools particularly on vinyl, laminate or similar hard surfaces.

Above weights do not include optional arm kits. ∴ FedEx weight is calculated using FedEx dimensional standards to determine billable weight. ∴ Pricing and specifications subject to change without notification.

# Maxwell (MXIU/PD)

Multi-shift | Heavy-duty

Please see pages 189 – 207 for arm kits, casters, and other options.

average / medium

Model	Description	Textile Grade-In	List	Specifications
<b>7878MX</b> 	<i>Simple Multi-Function (-7MX)</i>	Grade 1 / C.O.M.	\$1,365.00	Overall width 28"
	Pneumatic lift	Grade 2	\$1,390.00	Overall height 42.5" - 50.5"
	Tilting backrest	Grade 3 / Grade-in A	\$1,415.00	Back 18" w x 23" h
	EZ back height adjustment	Grade 4 / Grade-in B	\$1,440.00	Seat 24" w x 18-20.5" d
	Rocking tilt	Grade 5 / Grade-in C	\$1,465.00	Seat height 18" - 23"
	Tension knob	Grade 6 / Grade-in D	\$1,490.00	Travel range (ht.) 4" (back) / 5" (seat)
	Executive trim-back design			COM 2 yds.
	Seat depth adjustment			Carton / FedEx wt 68 lbs / 195 lbs
	Dual-tone universal soft casters			Arms Group 1* (no ETR1)
				*no KR23, KR23-45, KR23-65
			Warranty 7 year limited	





**DESIGN STATEMENT** Called the "Maxwell" for its MAX-size and WELL-structured construction, these chairs are big in so many aspects. Made of heavy-duty components from top to bottom, these full-size chairs with wide-back comfort and solid design are ideal for users up to 450 pounds.

The Maxwell is built to endure, and now redesigned with a tapered top and wide-based back rest to offer the same full support but with a less daunting appearance.

**NOTES** When upholstered in any Grade 5 ComfortKnit patterns (Solids, Architect, and Myth) MXIU Series back shells are upholstered in a high double-rub black fabric unless otherwise specified.

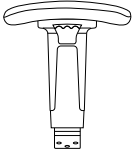
common options

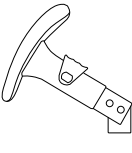
## Common Options for Maxwell Intensive use 24-7

Arms			
	<b>JR77 (1D Motion)</b> - list: 100.00 Fixed width, height adjustable T-arms with molded arm pads.  For specs and warranty, see page 192.		<b>KR200 (2D Motion)</b> - list: 119.00 Height and width adjustable, removable T-arms with natural grip control.  For specs and warranty, see page 193.
	<b>JRBN (1D Motion)</b> - list: 267.00 Fixed width T-arms with fold back feature and trigger-style height control with ballistic nylon upholstered arm pads.  <b>JRPD (1D Motion)</b> - list: 267.00 Fixed width T-arms with fold back feature and trigger-style height control with Memosoft arm pads.  For specs and warranty, see page 191.		<b>KR100M (2D Motion) (formerly KR240M)</b> - list: 144.00 Height and width adjustable, removable T-arms with natural grip control and Memosoft arm pads.  For specs and warranty, see page 193.

Above weights do not include optional arm kits. ; FedEx weight is calculated using FedEx dimensional standards to determine billable weight. ; Pricing and specifications subject to change without notification.



# OM5<sup>®</sup>

## Features:

- Begins @ \$880 armless / \$983 with OM5 arms (-A)
- A “modern classic” ideal for working environments from task to executive suites & boardrooms
- “Body-Activated Motion” responds to users’ weight without cumbersome tension knob Proprietary features such as Virtual Pause, Variable Back Response, Waterfall Flex, etc.
- Designed by Francisco Romero of Phidesign









# OM5® (OM5, OM5-EX)

Office | Conference | Executive

### OM5 Core Features:

- Waterfall flex feature seat
- Body-Activated Motion mechanism
- Virtual pause/lock
- Polyflex with variable back resistance
- 300 lbs. Weight Capacity
- Lifetime Limited Warranty





**Note:** Green font color indicates default build for "most popular" configuration of this spread.

1. Model		2. Frame Finish		3. Polyflex Back Finish		4. Arm Options (most popular)	
Code	List	Code	List	Code	List	Code	List
<b>OM5</b> 21" Back height	<b>\$864</b>	<b>-B</b> Modern Black (BK01)	<b>+\$0</b>	<b>-BK01</b> Modern Black	<b>+\$0</b>	<b>-N</b> No arm	<b>+\$0</b>
<b>OM5-EX</b> 24.5" Executive high back	<b>\$914</b>	<b>-G</b> Palladium Grey (GR01)	<b>+\$95</b>	<b>-GR01</b> Palladium Grey	<b>+\$0</b>	<b>-F</b> Fixed Arm Plug* (add -F in front of arm codes below to fix arm height)	<b>+\$5</b>
				<b>-WT01</b> Arctic White	<b>+\$0</b>	 <b>-A</b> Height adjustable OM5 Arms	<b>+\$103</b>
						 <b>A-RP45</b> Height adjustable with width adjustable, fore/aft, inward pivoting arm top	<b>+\$158</b>
						 <b>A-RP50</b> Height adjustable with width adjustable, fore/aft, inward pivoting arm top	<b>+\$208</b>
						 <b>A-RP65</b> Height adjustable with width adjustable, with lockable fore/aft, inward pivoting arm top	<b>+\$208</b>

For OM5-EX only  

\*Fixed arm height at 8.25" above the seat

### OTHER OPTIONS (append to above nomenclature to add to, or override existing options)

Casters and Glides		List	Seat Options		List	Accessories		List
	<b>-5OSS</b> 50mm safety soft casters, minimizes chair movement when <b>NOT</b> in use	<b>+\$25</b>		<b>-CFT</b> Memory foam insert for additional comfort	<b>+\$66</b>		<b>-HRD</b> Deluxe headrest with black leather-like upholstery	<b>+\$138</b>
	<b>-GLDR</b> Glides	<b>\$0</b>					<b>-CTR</b> Coat rack	<b>+\$105</b>

## MODEL CODE

Example: OM5 - B - BK01 - A-RP45 - 2570 - 2570 - STDB (new format) = OM5 - RP45 - PB - etc. (original format)

Model #    Frame finish    Polyflex finish    Arm    Back uph.    Seat uph.    Base pkg.    Model #    Arm    Polyflex Back

5. Back Upholstery Material	
Code	List
-PF Not upholstered	+\$0
-2300-2310 Zodiac Mesh**	+\$50
• Grade 1 / C.O.M.	+\$66
• Grade 2 / Grade-in A	+\$71
• Grade 3 / Grade-in B	+\$76
• Grade 4 / Grade-in C	+\$81
• Grade 5 / Grade-in D	+\$86
• Grade 6 / Grade-in E	+\$91
• LG1 Evita / C.O.L.	+\$135
• LG2 Lena - LDEL, LLUT, LORC only*	+\$145
• LG3 Vulcano - LMIT, LSTG only*	+\$155

\*For NON In-Stock colors, check with OM Seating for additional pricing details.

\*\*Zodiac Mesh for back only. Not available for upholstered seat

6. Seat Upholstery Material	
Code	List
• Grade 1 / C.O.M.	+\$0
• Grade 2 / Grade-in A	+\$15
• Grade 3 / Grade-in B	+\$30
• Grade 4 / Grade-in C	+\$45
• Grade 5 / Grade-in D	+\$60
• Grade 6 / Grade-in E	+\$75
• LG1 Evita / C.O.L.	+\$135
• LG2 Lena - LDEL, LLUT, LORC only*	+\$150
• LG3 Vulcano - LMIT, LSTG only*	+\$155

\*For NON In-Stock colors, check with OM Seating for additional pricing details.

7. Base Packages (includes cylinder, base, and casters)	
Code	List
<b>Black Base Package Options:</b>	
-XSB <b>Low Seat Height Package (Black)</b> (Seat height: 15.25" - 18.75") • <b>Cylinder:</b> 4" Black (4BCE) • <b>Base:</b> 27" Black nylon (27BM) • <b>Casters:</b> 65mm Grey two-tone multi-surface (65MS)	+\$30
-STDB <b>Standard Seat Height Package (Black)</b> (Seat height: 17" - 22") • <b>Cylinder:</b> 5" Black (5BM) • <b>Base:</b> 27" Black nylon (27BM) • <b>Casters:</b> 65mm Grey two-tone multi-surface (65MS)	+\$0
-HIB <b>High Seat Height Package (Black)</b> (Seat height: 19.75" - 26") • <b>Cylinder:</b> 5" Black (6BSHD) • <b>Base:</b> 27" Black nylon (27BM) • <b>Casters:</b> 65mm Grey two-tone multi-surface (65MS)	+\$40
<b>Polished Base Package Options:</b>	
-XSP <b>Low Seat Height Package (Polished)</b> (Seat height: 15.25" - 18.75") • <b>Cylinder:</b> 4" Chrome (4CCE) • <b>Base:</b> 27" Polished aluminum (27PM) • <b>Casters:</b> 65mm Grey two-tone multi-surface (65MS)	+\$98
-STDP <b>Standard Seat Height Package (Polished)</b> (Seat height: 17" - 22") • <b>Cylinder:</b> 5" Chrome (5CM) • <b>Base:</b> 27" Polished chrome (27PM) • <b>Casters:</b> 65mm Grey two-tone multi-surface (65MS)	+\$88
-HIP <b>High Seat Height Package (Polished)</b> (Seat height: 19.75" - 26") • <b>Cylinder:</b> 6" Chrome (6CHD) • <b>Base:</b> 27" Polished aluminum (27PM) • <b>Casters:</b> 65mm Grey two-tone multi-surface (65MS)	+108

\* For even more options, please refer to penultimate page of this price guide.



Dimensions	W	D	H (OM5)	H (OM5-EX)
Overall	27"	27"	37" - 42"	40" - 45"
Seat	19.75"	17-18.5"	16" - 21"	16" - 21"
Back	18"	N/A	21"	24.5"

Upholstery	Seat	Back
COM (OM5)	0.75 yds.	0.75 yds.
COM (OM5-EX)	1 yd.	1 yd.
Shipping	Carton Wt.	FedEx Wt.
(OM5)	64 lbs.	101 lbs.
(OM5-EX)	67 lbs.	195 lbs.

For OM5-EX only







# OM5® Task Stool (OM5-TS, OM5-EX-TS)

Workstations | Lab

### OM5-TS Core Features:

- Waterfall flex feature seat
- Body-Activated Motion mechanism
- Virtual pause/lock
- Polyflex with variable back resistance
- 300 lbs. Weight Capacity
- Lifetime Limited Warranty

**Note:** Green font color indicates default build for "most popular" configuration of this spread.





1. Model		2. Frame Finish		3. Polyflex Back Finish		4. Arm Options (most popular)		
Code	List	Code	List	Code	List	Code	List	
<b>OM5-TS</b> 21" Back height	<b>\$920</b>	<b>-B</b> Modern Black (BK01)	<b>+\$0</b>	<b>-BK01</b> Modern Black	<b>+\$0</b>		<b>-N</b> No arm	<b>+\$0</b>
<b>OM5-EX-TS</b> 24.5" Executive high back	<b>\$970</b>	<b>-G</b> Palladium Grey (GR01)	<b>+\$95</b>	<b>-GR01</b> Palladium Grey	<b>+\$0</b>		<b>-F</b> Fixed Arm Plug* (add -F in front of arm codes below to fix arm height)	<b>+\$5</b>
				<b>-WT01</b> Arctic White	<b>+\$0</b>		<b>-A</b> Height adjustable OM5 Arms	<b>+\$103</b>
							<b>A-RP45</b> Height adjustable with width adjustable, fore/aft, inward pivoting arm top	<b>+\$158</b>
							<b>A-RP50</b> Height adjustable with width adjustable, fore/aft, inward pivoting arm top	<b>+\$208</b>
							<b>A-RP65</b> Height adjustable with width adjustable, with lockable fore/aft, inward pivoting arm top	<b>+\$208</b>

For OM5-EX-TS only



\*Fixed arm height at 8.25" above the seat

### OTHER OPTIONS (append to above nomenclature to add to, or override existing options)

Casters and Glides		List	Seat Options		List	Accessories		List
	<b>-50SS</b> 50mm safety soft casters, minimizes chair movement when <b>NOT</b> in use	<b>+\$25</b>		<b>-CFT</b> Memory foam insert for additional comfort	<b>+\$66</b>		<b>-HRD</b> Deluxe headrest with black leather-like upholstery	<b>+\$138</b>
	<b>-GLDR</b> Glides	<b>+\$0</b>					<b>-CTR</b> Coat rack	<b>+\$105</b>

## MODEL CODE

Example: **OM5-TS - B - BK01 - A - 2570 - 2570 - 8GSPC** (new format) = **OM5 - A - PB** - etc. (original format)

Model #    Frame finish    Polyflex finish    Arm    Back uph.    Seat uph.    Base pkg.    Model #    Arm    Polyflex Back

5. Back Upholstery Material	
Code	List
<b>-PF</b> Not upholstered	<b>+\$0</b>
<b>-2300-2310</b> Zodiac Mesh**	<b>+\$50</b>
• <b>Grade 1 / C.O.M.</b>	<b>+\$66</b>
• <b>Grade 2 / Grade-in A</b>	<b>+\$71</b>
• <b>Grade 3 / Grade-in B</b>	<b>+\$76</b>
• <b>Grade 4 / Grade-in C</b>	<b>+\$81</b>
• <b>Grade 5 / Grade-in D</b>	<b>+\$86</b>
• <b>Grade 6 / Grade-in E</b>	<b>+\$91</b>
• <b>LG1 Evita / C.O.L.</b>	<b>+\$135</b>
• <b>LG2 Lena - LDEL, LLUT, LORC only*</b>	<b>+\$145</b>
• <b>LG3 Vulcano - LMIT, LSTG only*</b>	<b>+\$155</b>

\*For NON In-Stock colors, check with OM Seating for additional pricing details.

\*\*Zodiac Mesh for back only. Not available for upholstered seat

6. Seat Upholstery Material	
Code	List
• <b>Grade 1 / C.O.M.</b>	<b>+\$0</b>
• <b>Grade 2 / Grade-in A</b>	<b>+\$15</b>
• <b>Grade 3 / Grade-in B</b>	<b>+\$30</b>
• <b>Grade 4 / Grade-in C</b>	<b>+\$45</b>
• <b>Grade 5 / Grade-in D</b>	<b>+\$60</b>
• <b>Grade 6 / Grade-in E</b>	<b>+\$75</b>
• <b>LG1 Evita / C.O.L.</b>	<b>+\$135</b>
• <b>LG2 Lena - LDEL, LLUT, LORC only*</b>	<b>+\$150</b>
• <b>LG3 Vulcano - LMIT, LSTG only*</b>	<b>+\$155</b>

\*For NON In-Stock colors, check with OM Seating for additional pricing details.

7. Base Packages (includes cylinder, base, and casters)	
Code	List
<b>-8GSPC</b> <b>Standard Stool Height Package (Black)</b> (Seat height: 24" - 32") • <b>Cylinder:</b> 8" Chrome (8CHD) • <b>Base:</b> Chrome grande spider base with fixed 22" footring (22GSPC) • <b>Casters:</b> 65mm Grey two-tone multi-surface (65MS)	<b>+\$0</b>
<b>Black Base Packages:</b>	
<b>-8TLB</b> <b>Low Stool Height Package (Black)</b> (Seat height: 21" - 29") • <b>Cylinder:</b> 8" Black (8BAT) • <b>Footring:</b> 20" Turn-lock footring (20TL) • <b>Base:</b> 27" Black nylon (27BM) • <b>Casters:</b> 65mm Grey two-tone multi-surface (65MS)	<b>+\$0</b>
<b>-10TLB</b> <b>Standard Stool Height Package (Black)</b> (Seat height: 25" - 35") • <b>Cylinder:</b> 10" Chrome (10CHD) • <b>Footring:</b> 20" Turn-lock footring (20TL) • <b>Base:</b> 27" Black nylon (27BM) • <b>Casters:</b> 65mm Grey two-tone multi-surface (65MS)	<b>+\$0</b>
<b>Polished Base Packages:</b>	
<b>-8TLP</b> <b>Low Stool Height Package (Polished)</b> (Seat height: 21" - 29") • <b>Cylinder:</b> 8" Chrome (8CHD) • <b>Footring:</b> 20" Turn-lock footring (20TL) • <b>Base:</b> 27" Polished aluminum (27PM) • <b>Casters:</b> 65mm Grey two-tone multi-surface (65MS)	<b>+\$40</b>
<b>-10TLP</b> <b>Standard Stool Height Package (Polished)</b> (Seat height: 25" - 35") • <b>Cylinder:</b> 10" Chrome (10CHD) • <b>Footring:</b> 20" Turn-lock footring (20TL) • <b>Base:</b> 27" Polished aluminum (27PM) • <b>Casters:</b> 65mm Grey two-tone multi-surface (65MS)	<b>+\$40</b>

\* For even more options, please refer to penultimate page of this price guide.



Dimensions	W	D	H
Overall	27"	27"	45" - 35"
Seat	19.75"	17-18.5"	24" - 32"
Back	18"	N/A	21"

Upholstery	Seat	Back
COM	0.75 yds.	0.75 yds.
Shipping	Carton Wt.	FedEx Wt.
	64 lbs.	101 lbs.

For OM5-EX-TS only  
**FedEx**  
Ground  
oversize



**PHASING OUT**

**OM5® Xtra Tall (OM5-XT)**

Office | Conference | Executive

**OM5-XT Core Features:**

- Tall back
- Deep seat
- Body-Activated Motion mechanism

- Virtual pause/lock
- Polyflex with variable back resistance
- 300 lbs. Weight Capacity
- Lifetime Limited Warranty

**Note:** Green font color indicates default build for "most popular" configuration of this spread.

1. Model		2. Frame Finish		3. Polyflex Back Finish		4. Arm Options (most popular)	
Code	List	Code	List	Code	List	Code	List
<b>OM5-XT</b> 24.5" Back height	<b>\$885</b>	<b>-B</b> Modern Black (BK01)	<b>+\$0</b>	<b>-BK01</b> Modern Black	<b>+\$0</b>	<b>-N</b> No arm	<b>+\$0</b>
		<b>-G</b> Palladium Grey (GR01)	<b>+\$95</b>	<b>-GR01</b> Palladium Grey	<b>+\$0</b>	<b>-F</b> Fixed Arm Plug* (add -F in front of arm codes below to fix arm height)	<b>+\$5</b>
					<b>-WT01</b> Arctic White	<b>+\$0</b>	<b>-A</b> Height adjustable OM5 Arms
						<b>A-RP45</b> Height adjustable with width adjustable, fore/aft, inward pivoting arm top	<b>+\$158</b>
						<b>A-RP50</b> Height adjustable with width adjustable, fore/aft, inward pivoting arm top	<b>+\$208</b>
						<b>A-RP65</b> Height adjustable with width adjustable, with lockable fore/aft, inward pivoting arm top	<b>+\$208</b>

\*Fixed arm height at 8.25" above the seat

**OTHER OPTIONS** (append to above nomenclature to add to, or override existing options)

Casters and Glides		List	Seat Options		List	Accessories		List
	<b>-50SS</b> 50mm safety soft casters, minimizes chair movement when <b>NOT</b> in use	<b>+\$25</b>		<b>-CFT</b> Memory foam insert for additional comfort	<b>+\$66</b>		<b>-HRD</b> Deluxe headrest with black leather-like upholstery	<b>+\$138</b>
	<b>-GLDR</b> Glides	<b>\$0</b>					<b>-CTR</b> Coat rack	<b>\$105</b>

## MODEL CODE

Example: OM5-XT - B - BK01 - A - 2570 - 2570 - STDB (new format) = OM5 - A - PB - etc. (original format)

Model #    Frame finish    Polyflex finish    Arm    Back uph.    Seat uph.    Base pkg.    Model #    Arm    Polyflex Back

5. Back Upholstery Material	
Code	List
-PF Not upholstered	+\$0
-2300-2310 Zodiac Mesh**	+\$50
• Grade 1 / C.O.M.	+\$66
• Grade 2 / Grade-in A	+\$71
• Grade 3 / Grade-in B	+\$76
• Grade 4 / Grade-in C	+\$81
• Grade 5 / Grade-in D	+\$86
• Grade 6 / Grade-in E	+\$91
• LG1 Evita / C.O.L.	+\$145
• LG2 Lena - LDEL, LLUT, LORC only*	+\$155
• LG3 Vulcano - LMIT, LSTG only*	+\$165

\*For NON In-Stock colors, check with OM Seating for additional pricing details.

\*\*Zodiac Mesh for back only. Not available for upholstered seat

6. Seat Upholstery Material	
Code	List
• Grade 1 / C.O.M.	+\$0
• Grade 2 / Grade-in A	+\$20
• Grade 3 / Grade-in B	+\$40
• Grade 4 / Grade-in C	+\$60
• Grade 5 / Grade-in D	+\$80
• Grade 6 / Grade-in E	+\$100
• LG1 Evita / C.O.L.	+\$150
• LG2 Lena - LDEL, LLUT, LORC only*	+\$165
• LG3 Vulcano - LMIT, LSTG only*	+\$170

\*For NON In-Stock colors, check with OM Seating for additional pricing details.

7. Base Packages (includes cylinder, base, and casters)	
Code	List
-STDB (formerly SP-B) <b>Standard Seat Height Package (Black)</b> (Seat height: 18.5" - 23.5") • Cylinder: 5" black (5BM) • Base: 28" black nylon (28NXT) • Casters: 65mm grey two-tone multi-surface (65MS)	+\$0
-STDP (formerly SP-P) <b>Standard Seat Height Package (Polished)</b> (Seat height: 18.5" - 23.5") • Cylinder: 5" chrome (5CM) • Base: 28" polished aluminum (28PXT) • Casters: 65mm grey two-tone multi-surface (65MS)	+\$88

\* For even more options, please refer to penultimate page of this price guide.

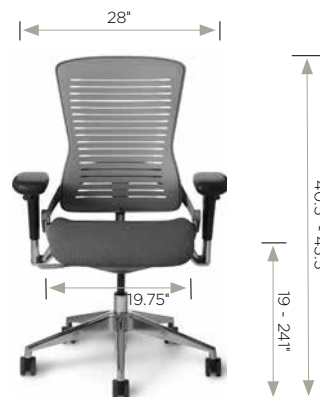

Dimensions	W	D	H
Overall	28"	28"	40.5" - 45.5"
Seat	19.75"	21"	19" - 24"
Back	18"	N/A	24.5"

Upholstery	Seat	Back
COM	1 yd.	1 yd.
Shipping	Carton Wt.	FedEx Wt.
	69 lbs.	195 lbs.







# OM5 Active®

## Features:

- Begins @ \$333 armless (OM5-AS) / \$376 with OM5 cantilever arms (OM5-AS-A . . . )
- OM5-AS - Sled-base mid-density stacking chair for any occasional use environment
- OM5-AG - 4-Leg stackable guest chair with options for casters or glides.
- OM5-AT - 5-Star base "tasker" for training rooms, computer labs, or simple task environments
- OM5-AC - Sled-base, stackable café stools with both bar and counter height seat options (30" & 24" seat heights, respectively)
- OM5-AN - Nesting, stacks 3, nests infinitely
- Designed by Francisco Romero of Phidesign





# OM5 Active® Nest (OM5-AN)

Nesting | Guest | Multi-use

### OM5 Active Nest Core Features:

- Unique Articulating Chair Top
- Stacks 3 and Nests Infinitely
- Built-in Ganging Clips
- 300 lb. Weight Capacity
- Lifetime Limited Warranty



**Note:** Green font color indicates default build for "most popular" configuration of this spread.

1. Model		2. Arms			3. Polyflex Shell Color Option		4. Back Upholstery	
Code	List	Code	List	Code	List	Code	List	
<b>OM5-AN</b> (Active Nest)	<b>\$545</b>	<b>-N</b> No arms	<b>+\$0</b>	<b>-BK01</b> Modern Black	<b>+\$0</b>	<b>PF Polyflex</b> (Unupholstered)	<b>+\$0</b>	
<b>OM5-FN</b> (InActive Nest)	<b>\$540</b>	<b>-A</b> With Arms	<b>+\$43</b>	<b>-GR01</b> Palladium Grey	<b>+\$0</b>	<b>Grade 1 / C.O.M.</b>	<b>+\$48</b>	
				<b>-WT01</b> Arctic White	<b>+\$0</b>	<b>Grade 2 / Grade-in A</b>	<b>+\$58</b>	
				<b>-GR04</b> Graphite	<b>+\$0</b>	<b>Grade 3 / Grade-in B</b>	<b>+\$68</b>	
				<b>-BL02</b> Navy Blue	<b>+\$0</b>	<b>Grade 4 / Grade-in C</b>	<b>+\$78</b>	
				<b>-RD02</b> Crimson Red	<b>+\$0</b>	<b>Grade 5 / Grade-in D</b>	<b>+\$88</b>	
				<b>-GNO3</b> Seafoam Green	<b>+\$0</b>	<b>Grade 6 / Grade-in E</b>	<b>+\$98</b>	
				<b>-YL01</b> Canary Yellow	<b>+\$0</b>	<b>LG1 (Evita) / C.O.L.</b>	<b>+\$100</b>	
						<b>• LG2 Lena - LDEL, LLUT, LORC only*</b>	<b>+\$110</b>	
						<b>• LG3 Vulcano - LMIT, LSTG only*</b>	<b>+\$120</b>	



Note: Bottom cover matches seat polycolor.

\*For NON In-Stock colors, check with OM Seating for additional pricing details.

### OTHER OPTIONS (append to above nomenclature to add to, or override existing options)

Glides & Casters		
Code		List
<b>-BKSG</b>	Modern Black Glides	<b>+\$0</b>
<b>-GRSG</b>	Palladium Grey Glides	<b>+\$0</b>
<b>-SOR</b>	Reverse Braking, restricted chair movement when chair IS in use	<b>+\$25</b>
<b>-WBB</b>	Wheelbarrow - Modern Black, Caster (front) and Glide (back) combo Note: matches BKCM Finish	<b>+\$10</b>
<b>-WBG</b>	Wheelbarrow - Palladium Grey, Caster (front) and Glide (back) combo Note: matches GRGM Finish	<b>+\$10</b>

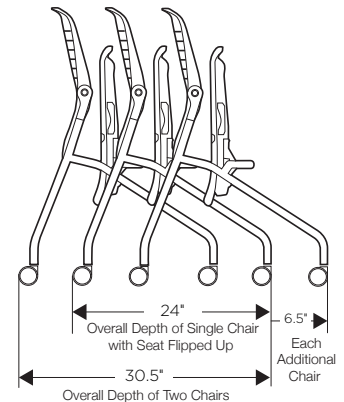





# OM5 Active® Sled (OM5-AS)

Stacking | Guest | Multi-use

### OM5 Active Sled Core Features:

- Unique Articulating Chair Top
- Built-in Ganging Clips
- 300 lb. Weight Capacity
- Lifetime Limited Warranty



**Note:** Green font color indicates default build for "most popular" configuration of this spread.

1. Model		2. Arms		3. Polyflex Shell Color Option	
Code	List	Code	List	Code	List
<b>OM5-AS</b> (Active Sled)	<b>\$327</b>	<b>-N</b> No arms	<b>+\$0</b>	<b>-BK01</b> Modern Black	<b>+\$0</b>
<b>OM5-FS</b> (InActive Sled)	<b>\$322</b>	<b>-A</b> With arms	<b>\$43</b>	<b>-GN01</b> Palladium Grey	<b>+\$0</b>
				<b>-WT01</b> Arctic White	<b>+\$0</b>
				<b>-GR04</b> Graphite	<b>+\$0</b>
				<b>-BL02</b> Navy Blue	<b>+\$0</b>
				<b>-RD02</b> Crimson Red	<b>+\$0</b>
				<b>-GN03</b> Seafoam Green	<b>+\$0</b>
				<b>-YL01</b> Canary Yellow	<b>+\$0</b>



**Note:** Bottom cover matches seat polycolor.

### OTHER OPTIONS (append to above nomenclature to add to, or override existing options)

Miscellaneous Options		List
	<b>-CFT</b> Foam insert (provides additional comfort)	<b>+\$66</b>
	<b>-BKTY</b> Book Tray, black only	<b>+\$58</b>
	<b>-FLTG</b> Set of 4 felt glides	<b>+\$10</b>
	<b>-STDLY5N</b> Stacking Dolly	<b>+\$397</b>

Stacking with Dolly  
20 unupholstered / 14 upholstered

Stacking Without Dolly  
4 unupholstered / 4 upholstered

(can not stack with BKTY option. CFT option will decrease stackable quantity)

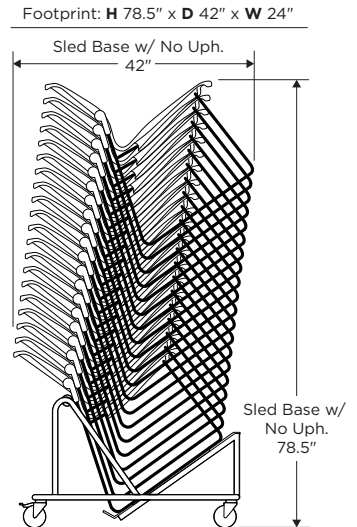

## MODEL CODE

Example: **OM5-AS - N - BK01 - PF - PF - BKCM** (new format)

Model #    Arm    Poly color    Back uph.    Seat uph.    Finish

4. Back Upholstery	
Code	List
<b>PF Polyflex</b> (Unupholstered)	<b>+\$0</b>
<b>Grade 1 / C.O.M.</b>	<b>+\$48</b>
<b>Grade 2 / Grade-in A</b>	<b>+\$58</b>
<b>Grade 3 / Grade-in B</b>	<b>+\$68</b>
<b>Grade 4 / Grade-in C</b>	<b>+\$78</b>
<b>Grade 5 / Grade-in D</b>	<b>+\$88</b>
<b>Grade 6 / Grade-in E</b>	<b>+\$98</b>
<b>LG1 (Evita) / C.O.L.</b>	<b>+\$100</b>
<b>LG2 Lena - LDEL, LLUT, LORC only*</b>	<b>+\$110</b>
<b>LG3 Vulcano - LMIT, LSTG only*</b>	<b>+\$120</b>

\*For NON In-Stock colors, check with OM Seating for additional pricing details.

5. Seat Upholstery	
Code	List
<b>PF Polyflex</b> (Unupholstered)	<b>+\$0</b>
<b>Grade 1 / C.O.M.</b>	<b>+\$48</b>
<b>Grade 2 / Grade-in A</b>	<b>+\$58</b>
<b>Grade 3 / Grade-in B</b>	<b>+\$68</b>
<b>Grade 4 / Grade-in C</b>	<b>+\$78</b>
<b>Grade 5 / Grade-in D</b>	<b>+\$88</b>
<b>Grade 6 / Grade-in E</b>	<b>+\$98</b>
<b>LG1 (Evita) / C.O.L.</b>	<b>+\$100</b>
<b>LG2 Lena - LDEL, LLUT, LORC only*</b>	<b>+\$110</b>
<b>LG3 Vulcano - LMIT, LSTG only*</b>	<b>+\$120</b>

\*For NON In-Stock colors, check with OM Seating for additional pricing details.

6. Finish Options (Frame, Armless and Arms Finish)	
Code	List
<b>-BKCM</b> <b>(STD) Modern Black Color Match</b> • <b>Frame Finish:</b> Modern Black • <b>Armless/Arms Finish:</b> Modern Black	<b>\$0</b>
<b>-GRCM</b> <b>Palladium Grey Color Match</b> • <b>Frame Finish:</b> Palladium Grey • <b>Armless/Arms Finish:</b> Palladium Grey	<b>\$0</b>
<b>-CHBK</b> • <b>Frame Finish:</b> Chrome • <b>Armless/Arms Finish:</b> Modern Black	<b>\$0</b>
<b>-CHGR</b> • <b>Frame Finish:</b> Chrome • <b>Armless/Arms Finish:</b> Palladium Grey	<b>\$0</b>
<b>-GRBK</b> • <b>Frame Finish:</b> Palladium Grey • <b>Armless/Arms Finish:</b> Modern Black	<b>\$0</b>

**Armless**

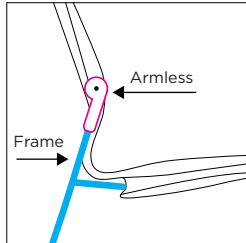

**Arms**

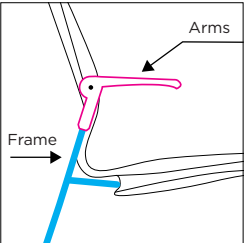



OM5 Active Ganging Clips  
Built in ganging clips on both Sled (arm / armless)  
and Guest (arm / armless)

Armless - Ganging Dimensions

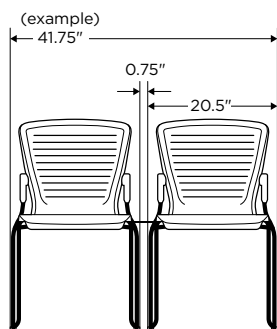

Arms - Ganging Dimensions

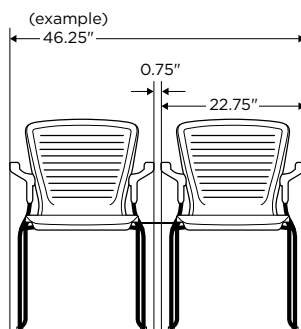

Dimensions	W	D	H
Overall	20.5" armless 22.75" w/ arms	24"	32.5"
Seat	18"	18"	18"
Back	17.5"	N/A	16"

Upholstery	Back	Seat	Backshell
COM	0.75 yds	0.75 yds	N/A
Shipping*	Carton Wt.	FedEx Wt.	
	25 lbs.	121 lbs.	

\*Ships up to 2 per carton. A \$20 Net fee will apply for split cartoning (i.e., 2 Actives in 2 cartons)



# OM5 Active® Café (OM5-AC)

Bar Height | Counter Height

### OM5 Active Café Core Features:

- Counter or Bar Height Sled Base Café Stool
- Unique Articulating Chair Top
- 300 lb. Weight Capacity
- Lifetime Limited Warranty



**Note:** Green font color indicates default build for "most popular" configuration of this spread.

1. Model		2. Arms		3. Polyflex Shell Color Option		4. Back Upholstery	
Code	List	Code	List	Code	List	Code	List
<b>OM5-AC-24</b> (24" Active Café)	<b>\$512</b>	<b>-N</b> No arms	<b>+\$0</b>	<b>-BK01</b> Modern Black	<b>+\$0</b>	<b>PF Polyflex</b> (Unupholstered)	<b>+\$0</b>
<b>OM5-AC-30</b> (30" Active Café)	<b>\$512</b>	<b>-A</b> With Arms	<b>+\$43</b>	<b>-GN01</b> Palladium Grey	<b>+\$0</b>	<b>Grade 1 / C.O.M.</b>	<b>+\$48</b>
<b>OM5-FC-24</b> (24" InActive Café)	<b>\$507</b>			<b>-WT01</b> Arctic White	<b>+\$0</b>	<b>Grade 2 / Grade-in A</b>	<b>+\$58</b>
<b>OM5-FC-30</b> (30" InActive Café)	<b>\$507</b>			<b>-GR04</b> Graphite	<b>+\$0</b>	<b>Grade 3 / Grade-in B</b>	<b>+\$68</b>
				<b>-BL02</b> Navy Blue	<b>+\$0</b>	<b>Grade 4 / Grade-in C</b>	<b>+\$78</b>
				<b>-RD02</b> Crimson Red	<b>+\$0</b>	<b>Grade 5 / Grade-in D</b>	<b>+\$88</b>
				<b>-GN03</b> Seafoam Green	<b>+\$0</b>	<b>Grade 6 / Grade-in E</b>	<b>+\$98</b>
				<b>-YL01</b> Canary Yellow	<b>+\$0</b>	<b>LG1 (Evita) / C.O.L.</b>	<b>+\$100</b>
						<b>• LG2 Lena - LDEL, LLUT, LORC only*</b>	<b>+\$110</b>
						<b>• LG3 Vulcano - LMIT, LSTG only*</b>	<b>+\$120</b>



**Note:** Bottom cover matches seat polycolor.

\*For NON In-Stock colors, check with OM Seating for additional pricing details.

### OTHER OPTIONS (append to above nomenclature to add to, or override existing options)

Miscellaneous Options		List
	<b>-CFT</b> (formerly <b>-UPHCFT</b> ) Foam insert (provides additional comfort)	<b>+\$66</b>
	<b>-BKTY</b> Book Tray, Black only	<b>+\$58</b>

### Stack 3 unupholstered or 3 upholstered without a Dolly

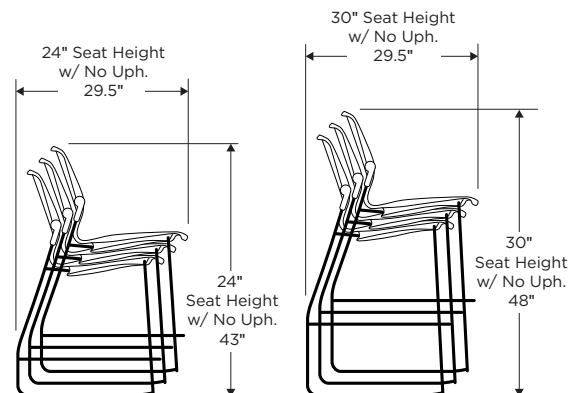

## MODEL CODE

Example: OM5-AC-24 - N - BK01 - PF - PF - BKCM (new format)

Model #    Arm    Poly color    Back uph.    Seat uph.    Finish

5. Seat Upholstery	
Code	List
<b>PF Polyflex</b> (Unupholstered)	<b>+\$0</b>
<b>Grade 1 / C.O.M.</b>	<b>+\$48</b>
<b>Grade 2 / Grade-in A</b>	<b>+\$58</b>
<b>Grade 3 / Grade-in B</b>	<b>+\$68</b>
<b>Grade 4 / Grade-in C</b>	<b>+\$78</b>
<b>Grade 5 / Grade-in D</b>	<b>+\$88</b>
<b>Grade 6 / Grade-in E</b>	<b>+\$98</b>
<b>LG1 (Evita) / C.O.L.</b>	<b>+\$100</b>
• <b>LG2 Lena - LDEL, LLUT, LORC only*</b>	<b>+\$110</b>
• <b>LG3 Vulcano - LMIT, LSTG only*</b>	<b>+\$120</b>

\*For NON In-Stock colors, check with OM Seating for additional pricing details.

6. Finish Options (Frame, Armless and Arms Finish)	
Code	List
<b>-BKCM</b> <i>(STD) Modern Black Color Match</i> • <b>Frame Finish:</b> Modern Black • <b>Armless/Arms Finish:</b> Modern Black	<b>+\$0</b>
<b>-CHBK</b> • <b>Frame Finish:</b> Chrome • <b>Armless/Arms Finish:</b> Modern Black	<b>+\$0</b>
<b>-CHGR</b> • <b>Frame Finish:</b> Chrome • <b>Armless/Arms Finish:</b> Palladium Grey	<b>+\$0</b>

**Armless**

**Arms**

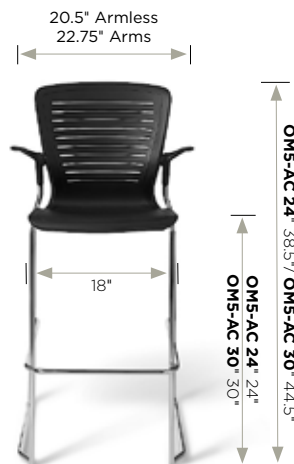

### OM5-AC 24" and 30"

Dimensions	W	D	H
Overall	20.5" armless 22.75" w/ arms	25"	<b>OM5-AC 24"</b> 38.5" <b>OM5-AC 30"</b> 44.5"
Seat	18"	18"	<b>OM5-AC 24"</b> 24" <b>OM5-AC 30"</b> 30"
Back	17.5"	N/A	16"

Upholstery	Back	Seat	Backshell
COM	0.75 yds	0.75 yds	N/A
Shipping	Carton Wt.	FedEx Wt.	
	<b>OM5-AC 24"</b> 27 lbs. <b>OM5-AC 30"</b> 30 lbs.	165 lbs.	





# OM5 Active® Guest (OM5-AG)

Stacking | Guest | Multi-use

## OM5 Active 4-leg Guest Core Features:

- Unique Articulating Chair Top
- Built-in Ganging Clips
- 300 lb. Weight Capacity
- Lifetime Limited Warranty



**Note:** Green font color indicates default build for "most popular" configuration of this spread.

1. Model		2. Arms		3. Polyflex Shell Color Option		4. Back Upholstery	
Code	List	Code	List	Code	List	Code	List
<b>OM5-AG</b> (Active Guest)	<b>\$355</b>	<b>-N</b> No arms	<b>+\$0</b>	<b>-BK01</b> Modern Black	<b>+\$0</b>	<b>PF Polyflex</b> (Unupholstered)	<b>+\$0</b>
<b>OM5-FG</b> (InActive Guest)	<b>\$350</b>	<b>-A</b> With arms	<b>\$43</b>	<b>-GN01</b> Palladium Grey	<b>+\$0</b>	<b>Grade 1 / C.O.M.</b>	<b>+\$48</b>
		<b>-TABR</b> Right handed tablet arm*	<b>\$125</b>	<b>-WT01</b> Arctic White	<b>+\$0</b>	<b>Grade 2 / Grade-in A</b>	<b>+\$58</b>
		<b>-TABL</b> Left handed tablet arm*	<b>\$125</b>	<b>-GR04</b> Graphite	<b>+\$0</b>	<b>Grade 3 / Grade-in B</b>	<b>+\$68</b>
				<b>-BL02</b> Navy Blue	<b>+\$0</b>	<b>Grade 4 / Grade-in C</b>	<b>+\$78</b>
				<b>-RD02</b> Crimson Red	<b>+\$0</b>	<b>Grade 5 / Grade-in D</b>	<b>+\$88</b>
				<b>-GN03</b> Seafoam Green	<b>+\$0</b>	<b>Grade 6 / Grade-in E</b>	<b>+\$98</b>
				<b>-YL01</b> Canary Yellow	<b>+\$0</b>	<b>LG1 (Evita) / C.O.L.</b>	<b>+\$100</b>
						<b>• LG2 Lena - LDEL, LLUT, LORC only*</b>	<b>+\$110</b>
						<b>• LG3 Vulcano - LMIT, LSTG only*</b>	<b>+\$120</b>



\*includes arm pads and available in black only.

**Note:** Bottom cover matches seat polycolor.

\*For NON In-Stock colors, check with OM Seating for additional pricing details.

## OTHER OPTIONS (append to above nomenclature to add to, or override existing options)

Miscellaneous Options		List
	<b>-CFT</b> (formerly -UPHCFT) Foam insert (provides additional comfort)	<b>+\$66</b>
	<b>-BKTY</b> Book Tray, black only	<b>+\$58</b>
	<b>-STDLY5N</b> Stacking Dolly	<b>+\$397</b>

Stacking with Dolly  
15 unupholstered / 9 upholstered

Stacking Without Dolly  
4 unupholstered / 4 upholstered

(can not stack with TABR, TABL or BKTY option. CFT option will decrease quantity)

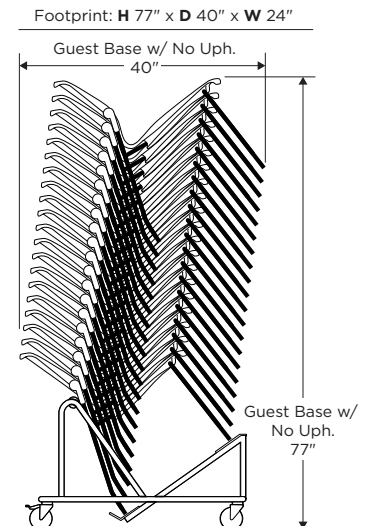



## MODEL CODE

Example: **OM5-AG - N - BK01 - PF - PF - BKCM - BKSG** (new format)

Model #    Arm    Poly color    Back uph.    Seat uph.    Finish    Casters

5. Seat Upholstery	
Code	List
<b>PF Polyflex</b> (Unupholstered)	<b>+\$0</b>
<b>Grade 1 / C.O.M.</b>	<b>+\$48</b>
<b>Grade 2 / Grade-in A</b>	<b>+\$58</b>
<b>Grade 3 / Grade-in B</b>	<b>+\$68</b>
<b>Grade 4 / Grade-in C</b>	<b>+\$78</b>
<b>Grade 5 / Grade-in D</b>	<b>+\$88</b>
<b>Grade 6 / Grade-in E</b>	<b>+\$98</b>
<b>LG1 (Evita) / C.O.L.</b>	<b>+\$100</b>
<b>• LG2 Lena - LDEL, LLUT, LORC only*</b>	<b>+\$110</b>
<b>• LG3 Vulcano - LMIT, LSTG only*</b>	<b>+\$120</b>

\*For NON In-Stock colors, check with OM Seating for additional pricing details.



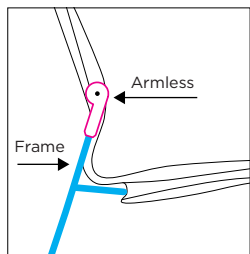

6. Finish Options (Frame, Armless and Arms Finish)	
Code	List
<b>-BKCM</b> <b>(STD) Modern Black Color Match</b> • <b>Frame Finish:</b> Modern Black • <b>Armless/Arms Finish:</b> Modern Black	<b>+\$0</b>
<b>-GRCM</b> <b>Palladium Grey Color Match</b> • <b>Frame Finish:</b> Palladium Grey • <b>Armless/Arms Finish:</b> Palladium Grey	<b>+\$0</b>
<b>-GRBK</b> • <b>Frame Finish:</b> Palladium Grey • <b>Armless/Arms Finish:</b> Modern Black	<b>+\$0</b>

**Armless**

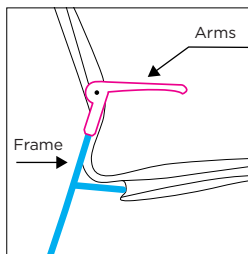

**Arms**



7. Caster Option	
Code	List
 <b>-BKSG</b> Modern Black glides (STD on BKCM)	<b>+\$0</b>
 <b>-GRSG</b> Palladium Grey glides (STD with GRCM and GRBK)	<b>+\$0</b>
 <b>-50S</b> (formerly AG) Active soft casters	<b>+\$15</b>
 <b>-50SS</b> (formerly -SS) Safety soft casters	<b>+\$25</b>
 <b>-55MSB</b> 55mm black two-tone multi-surface (55MSB) Note: matches BKCM Finish	<b>+\$0</b>
 <b>-55MSG</b> 55mm Grey two-tone multi-surface (55MSG) Note: matches GRCM Finish	<b>+\$0</b>
 <b>-WBB</b> Wheelbarrow - Modern Black, Caster (front) and Glide (back) combo Note: matches BKCM Finish	<b>+\$10</b>
 <b>-WBG</b> Wheelbarrow - Palladium Grey, Caster (front) and Glide (back) combo Note: matches GRCM Finish	<b>+\$10</b>

\*Glide will match frame finish.



OM5 Active Ganging Clips  
Built in ganging clips on both Sled (arm / armless) and Guest (arm / armless)

Armless - Ganging Dimensions

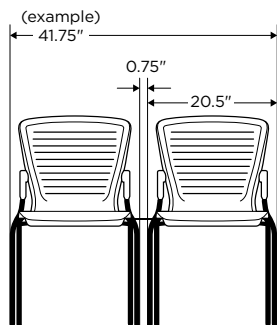

Arms - Ganging Dimensions

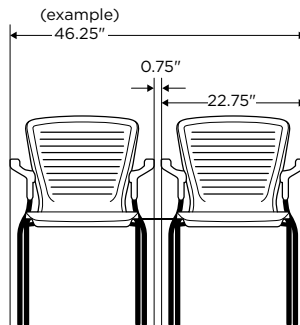

Dimensions	W	D	H
Overall	20.5" armless 22.75" w/ arms	24"	33"
Seat	18"	18"	18"
Back	17.5"	N/A	16"

Upholstery	Back	Seat	Backshell
COM	0.75 yds	0.75 yds	N/A
Shipping*	Carton Wt.	FedEx Wt.	
	28 lbs.	121 lbs.	

\*Ships up to 2 per carton. A \$20 Net fee will apply for split cartoning (i.e., 2 Actives in 2 cartons)



# OM5 Active® Multi-Tasker (OM5-AT)

Light Tasking | Multi-use

### OM5 Active Tasker Core Features:

- 5-star Light Multi-Tasker
- Unique Articulating Chair Top
- 300 lb. Weight Capacity
- Lifetime Limited Warranty



**Note:** Green font color indicates default build for "most popular" configuration of this spread.

1. Model		2. Arms		3. Polyflex Shell Color Option		4. Back Upholstery	
Code	List	Code	List	Code	List	Code	List
<b>OM5-AT</b> (Active Tasker)	<b>\$409</b>	<b>-N</b> No arms	<b>+\$0</b>	<b>-BK01</b> Modern Black	<b>+\$0</b>	<b>PF Polyflex</b> (Unupholstered)	<b>+\$0</b>
<b>OM5-FT</b> (InActive Tasker)	<b>\$404</b>	<b>-A</b> With arms	<b>\$43</b>	<b>-GN01</b> Palladium Grey	<b>+\$0</b>	<b>Grade 1 / C.O.M.</b>	<b>+\$48</b>
				<b>-WT01</b> Arctic White	<b>+\$0</b>	<b>Grade 2 / Grade-in A</b>	<b>+\$58</b>
				<b>-GR04</b> Graphite	<b>+\$0</b>	<b>Grade 3 / Grade-in B</b>	<b>+\$68</b>
				<b>-BL02</b> Navy Blue	<b>+\$0</b>	<b>Grade 4 / Grade-in C</b>	<b>+\$78</b>
				<b>-RD02</b> Crimson Red	<b>+\$0</b>	<b>Grade 5 / Grade-in D</b>	<b>+\$88</b>
				<b>-GN03</b> Seafoam Green	<b>+\$0</b>	<b>Grade 6 / Grade-in E</b>	<b>+\$98</b>
				<b>-YL01</b> Canary Yellow	<b>+\$0</b>	<b>LG1 (Evita) / C.O.L.</b>	<b>+\$100</b>
						<b>• LG2 Lena - LDEL, LLUT, LORC only*</b>	<b>+\$110</b>
						<b>• LG3 Vulcano - LMIT, LSTG only*</b>	<b>+\$120</b>

**Note:** Bottom cover matches seat polycolor.

\*For NON In-Stock colors, check with OM Seating for additional pricing details.

### OTHER OPTIONS (append to above nomenclature to add to, or override existing options)

Miscellaneous Options		List	Caster Options		List	Caster Options		List
	<b>-CFT</b> (formerly -UPHCF) Foam insert (provides additional comfort)	<b>+\$66</b>		<b>-50BC</b> (formerly -TC) 50mm Carpet Casters (Standard on Base Package STDB)	<b>\$0</b>		<b>-65MS</b> (formerly -SC) 65mm Grey two-tone multi-surface soft caster	<b>\$25</b>
				<b>-55MSB</b> 55mm Black Two Tone Multi-Surface Soft Caster Standard on STDP Base Package Option on STDW Base Package	<b>\$0</b>		<b>-50SS</b> (formerly -SS) 50mm Safety Soft Casters (minimizes chair movement when <b>NOT</b> in use)	<b>\$25</b>
				<b>-55MSW</b> 55mm White Two-Tone Multi-Surface Soft Caster Standard on STDW Base Package Option on STDP Base Package	<b>\$0</b>		<b>-50R</b> (formerly -REV) 50mm Reverse Braking Caster (restricts chair movement when chair <b>IS</b> in use)	<b>\$35</b>
				<b>-GLDR</b> (formerly -G) Glides	<b>\$0</b>		<b>-RUB</b> Rubber Casters	<b>\$25</b>
				<b>-50S</b> (formerly -AG) 50mm Soft Casters	<b>\$20</b>			



## MODEL CODE

Example: **OM5-AT - N - BK01 - PF - PF - STDB** (new format)

Model #    Arm    Poly color    Back uph.    Seat uph.    Base pkg.

5. Seat Upholstery	
Code	List
<b>PF Polyflex</b> (Unupholstered)	<b>+\$0</b>
<b>Grade 1 / C.O.M.</b>	<b>+\$48</b>
<b>Grade 2 / Grade-in A</b>	<b>+\$58</b>
<b>Grade 3 / Grade-in B</b>	<b>+\$68</b>
<b>Grade 4 / Grade-in C</b>	<b>+\$78</b>
<b>Grade 5 / Grade-in D</b>	<b>+\$88</b>
<b>Grade 6 / Grade-in E</b>	<b>+\$98</b>
<b>LG1 (Evita) / C.O.L.</b>	<b>+\$100</b>
• <b>LG2 Lena - LDEL, LLUT, LORC only*</b>	<b>+\$110</b>
• <b>LG3 Vulcano - LMIT, LSTG only*</b>	<b>+\$120</b>

\*For NON In-Stock colors, check with OM Seating for additional pricing details.

6. Task Base Packages (Includes Base, Cylinder and Casters)		
Code		List
	<b>-STDB (formerly -B25)</b> <b>Standard Seat Height Package (Black)</b> (Seat height: 16.5" - 21") <ul style="list-style-type: none"> <li>• <b>Cylinder:</b> 5" Black (5AF)</li> <li>• <b>Base:</b> 25" Black nylon (25BAT)</li> <li>• <b>Casters:</b> 50mm Black carpet casters (50BC)</li> </ul>	<b>\$0</b>
	<b>-STDP (formerly -WP25)</b> <b>Standard Seat Height Package (Polished)</b> (Seat height: 16.5" - 21") <ul style="list-style-type: none"> <li>• <b>Cylinder:</b> 5" Black (5BWY)</li> <li>• <b>Base:</b> 25" Two-tone polished aluminum (25PWY)</li> <li>• <b>Casters:</b> 55mm Black two-tone multi-surface (55MSB)</li> </ul>	<b>\$68</b>
	<b>-STDW (formerly -WW25)</b> <b>Standard Seat Height Package (White)</b> (Seat height: 16.5" - 21") <ul style="list-style-type: none"> <li>• <b>Cylinder:</b> 5" White (5WWY)</li> <li>• <b>Base:</b> 25" White powdercoat (25WWY)</li> <li>• <b>Casters:</b> 55mm White two-tone multi-surface (55MSW)</li> </ul>	<b>\$78</b>



Dimensions	W	D	H
Overall	25"	25"	32" - 36.5"
Seat	18"	18"	16.5" - 21"
Back	17.5"	N/A	16"

Upholstery	Back	Seat	Backshell
COM	0.75 yds	0.75 yds	N/A
Shipping	Carton Wt.	FedEx Wt.	
	35 lbs.	65 lbs.	



# OM5 Active® Multi-Tasker Stool (OM5-ATS)

Multi-use | Task Stool

## OM5 Active Multi-Tasker Core Features:

- Multi-Tasker Stool with Turn-lock footring or Fixed Footring
- Unique Articulating Chair Top
- 300 lb. Weight Capacity
- Lifetime Limited Warranty



**Note:** Green font color indicates default build for "most popular" configuration of this spread.

1. Model		2. Arms		3. Polyflex Shell Color Option		4. Back Upholstery	
Code	List	Code	List	Code	List	Code	List
<b>OM5-ATS</b> (Active Tasker Stool)	<b>\$527</b>	<b>-N</b> No arms	<b>+\$0</b>	<b>-BK01</b> Modern Black	<b>+\$0</b>	<b>PF Polyflex</b> (Unupholstered)	<b>+\$0</b>
<b>OM5-FTS</b> (InActive Tasker Stool)	<b>\$522</b>	<b>-A</b> With arms	<b>\$43</b>	<b>-GN01</b> Palladium Grey	<b>+\$0</b>	<b>Grade 1 / C.O.M.</b>	<b>+\$48</b>
				<b>-WT01</b> Arctic White	<b>+\$0</b>	<b>Grade 2 / Grade-in A</b>	<b>+\$58</b>
				<b>-GR04</b> Graphite	<b>+\$0</b>	<b>Grade 3 / Grade-in B</b>	<b>+\$68</b>
				<b>-BL02</b> Navy Blue	<b>+\$0</b>	<b>Grade 4 / Grade-in C</b>	<b>+\$78</b>
				<b>-RD02</b> Crimson Red	<b>+\$0</b>	<b>Grade 5 / Grade-in D</b>	<b>+\$88</b>
				<b>-GN03</b> Seafoam Green	<b>+\$0</b>	<b>Grade 6 / Grade-in E</b>	<b>+\$98</b>
				<b>-YL01</b> Canary Yellow	<b>+\$0</b>	<b>LG1 (Evita) / C.O.L.</b>	<b>+\$100</b>
						<b>• LG2 Lena - LDEL, LLUT, LORC only*</b>	<b>+\$110</b>
						<b>• LG3 Vulcano - LMIT, LSTG only*</b>	<b>+\$120</b>

**Note:** Bottom cover matches seat polycolor.

\*For NON In-Stock colors, check with OM Seating for additional pricing details.

## OTHER OPTIONS (append to above nomenclature to add to, or override existing options)

Miscellaneous Options		List	Caster Options		List	Substitute Cylinders		
	<b>-CFT</b> (formerly -UPHCFT) Foam insert (provides additional comfort)	<b>+\$66</b>		<b>-GLDR</b> (formerly -G) Glides	<b>+\$0</b>		<b>-OB8</b> 8" Black Cylinder	<b>+\$0</b>
				<b>-50S</b> (formerly -AG) 50mm Soft Casters	<b>\$20</b>			
				<b>-50SS</b> (formerly -SS) 50mm Safety Soft Casters (minimizes chair movement when NOT in use.)	<b>\$25</b>		<b>-OC8</b> 8" Chrome Cylinder	<b>+\$30</b>
				<b>-50R</b> (formerly -REV) 50mm Reverse Braking Casters (restricts chair movement when chair IS in use.)	<b>\$35</b>			
				<b>-RUB</b> Rubber Casters	<b>\$25</b>			





## MODEL CODE

Example: **OM5-ATS - N - BK01 - PF - PF - 8TLB** (new format)

Model #    Arm    Poly color    Back uph.    Seat uph.    Base pkg.

5. Seat Upholstery	
Code	List
<b>PF Polyflex</b> (Unupholstered)	<b>+\$0</b>
<b>Grade 1 / C.O.M.</b>	<b>+\$48</b>
<b>Grade 2 / Grade-in A</b>	<b>+\$58</b>
<b>Grade 3 / Grade-in B</b>	<b>+\$68</b>
<b>Grade 4 / Grade-in C</b>	<b>+\$78</b>
<b>Grade 5 / Grade-in D</b>	<b>+\$88</b>
<b>Grade 6 / Grade-in E</b>	<b>+\$98</b>
<b>LG1 (Evita) / C.O.L.</b>	<b>+\$100</b>
<b>• LG2 Lena - LDEL, LLUT, LORC only*</b>	<b>+\$110</b>
<b>• LG3 Vulcano - LMIT, LSTG only*</b>	<b>+\$120</b>

\*For NON In-Stock colors, check with OM Seating for additional pricing details.

6. Stool Base Packages (Includes Base, Cylinder and Casters)		
Code		List
<b>Adjustable Footring</b>		
	<b>-8TLB</b> <b>Standard Height Package with Adjustable Footring (Black)</b> (Seat height: 21" - 29") • <b>Cylinder:</b> 8" Black (8BAT) • <b>Footring:</b> 20" Turn-lock footring • <b>Base:</b> 27" Black nylon (27BM) • <b>Casters:</b> 65mm Grey two-tone multi-surface soft caster (65MS)	<b>+\$0</b>
	<b>-8TLP</b> <b>Standard Height Package with Adjustable Footring (Polished)</b> (Seat height: 21" - 29") • <b>Cylinder:</b> 8" Chrome (8CHD) • <b>Footring:</b> 20" Turn-lock footring • <b>Base:</b> 27" Polished aluminum (27PM) • <b>Casters:</b> 65mm Grey two-tone multi-surface soft caster (65MS)	<b>+\$68</b>
	<b>-10TLB</b> <b>High Seat Height Package with Adjustable Footring (Black)</b> (Seat height: 25" - 35") • <b>Cylinder:</b> 10" Chrome (10CHD) • <b>Footring:</b> 20" Turn-lock footring • <b>Base:</b> 27" Black nylon (27BM) • <b>Casters:</b> 65mm Grey two-tone multi-surface soft caster (65MS)	<b>+\$30</b>
	<b>-10TLP</b> <b>High Seat Height Package with Adjustable Footring (Polished)</b> (Seat height: 25" - 35") • <b>Cylinder:</b> 10" Chrome (10CHD) • <b>Footring:</b> 20" Turn-lock footring • <b>Base:</b> 27" Polished aluminum (27PM) • <b>Casters:</b> 65mm Grey two-tone multi-surface soft caster (65MS)	<b>+\$98</b>
<b>Fixed Footring</b>		
	<b>-8GSPC</b> <b>Standard Height Package with Fixed Footring (Chrome)</b> (Seat height: 23.5" - 31.5") • <b>Cylinder:</b> 8" Chrome (8CHD) • <b>Base:</b> Chrome Grande Spider Base with fixed 22" footring (22GSPC) • <b>Casters:</b> 65mm Grey two-tone multi-surface (65MS)	<b>-\$30</b>

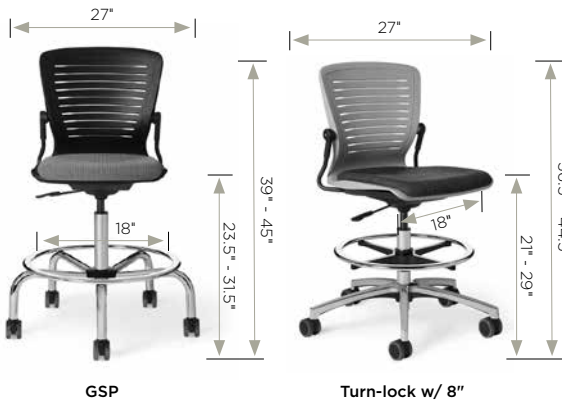

Dimensions are the same for Turn-lock with 8", Turn-lock w/10" and GSP except the overall height and seat height.

Dimensions (Turn-lock & GSP)	W	D	H (Turn-lock w/ 8")	H (Turn-lock w/ 10")	H (GSP)
Overall	27"	27"	36.5" - 44.5"	40.5" - 50.5"	39" - 47"
Seat	18"	18"	21" - 29"	25" - 36"	23.5" - 31.5"
Back	17.5"	N/A	16"		

Upholstery	Back	Seat	Backshell
COM	0.75 yds	0.75 yds	N/A
Shipping	Carton Wt.	FedEx Wt.	
	35 lbs.	65 lbs.	



# PA/PC

(To be renamed "PAC" in 2024)

## Features:

- Begins @ \$501 armless / \$620 with KR200 arms (PA53)
- PA5x, -6x - Popular, simple task chairs good for anyplace that work could happen!
- PC5x - Full-featured office and work chairs with a full range of ergonomic adjustments
- Wide range of size options within the series to fit any user "big" to "small"



# Patriot Series (PA)

(PA | to be renamed "PAC" in 2024)

Value line | General office

Please see pages 105, 189 – 207 for arm kits, casters, and other options.

small / petite

Model	Description	Value Line	Textile Grade-In	List	Specifications
<b>PA53</b> (aka, PAC53-7a)	<i>Simple Multi-Function (-7a)</i>		Grade 1 / C.O.M.	\$501.00	Overall width 25"
	Pneumatic lift		Grade 2 / Grade-in A	\$521.00	Overall height 32" - 40"
	Tilting backrest		Grade 3 / Grade-in B	\$541.00	Back 17.5" w x 16.5" h
	EZ back height adjustment		Grade 4 / Grade-in C	\$561.00	Seat 19" w x 17-20.1" d
	Seat tilting		Grade 5 / Grade-in D	\$581.00	Seat height 16" - 21"
	Seat depth adjustment		Grade 6 / Grade-in E	\$601.00	Travel range (ht.) 3" (back) / 5" (seat)
	55mm multi-surface casters (STD)		LG1 (Evita) / C.O.L.	\$721.00	COM 1 yd.
			LG2 (Lena-LDEL, LLUT, LORC only)*	\$746.00	Carton / FedEx wt 54 lbs / 101 lbs
			LG3 (Vulcano-LMIT, LSTG only)*	\$776.00	Arms Group 1 & 4
					Warranty 12 year limited



300  
POUNDS  
CAPACITY

\*For NON In-Stock colors, check with OM Seating for additional pricing details.

Model	Description	Value Line	Textile Grade-In	List	Specifications
<b>PA63</b> (aka, PAC63)	<i>Management Synchro (-1)</i>		Grade 1 / C.O.M.	\$568.00	Overall width 25"
	Pneumatic lift		Grade 2 / Grade-in A	\$588.00	Overall height 32" - 40"
	EZ back height adjustment		Grade 3 / Grade-in B	\$608.00	Back 17.5" w x 16.5" h
	<b>3-stage locking tilt</b>		Grade 4 / Grade-in C	\$628.00	Seat 19" w x 17-20.1" d
	<i>Synchronous seat/back tilt</i>		Grade 5 / Grade-in D	\$648.00	Seat height 16" - 21"
	Seat depth adjustment		Grade 6 / Grade-in E	\$668.00	Travel range (ht.) 3" (back) / 5" (seat)
	Tension knob		LG1 (Evita) / C.O.L.	\$788.00	COM 1 yd.
	55mm multi-surface casters (STD)		LG2 (Lena-LDEL, LLUT, LORC only)*	\$813.00	Carton / FedEx wt 54 lbs / 101 lbs
			LG3 (Vulcano-LMIT, LSTG only)*	\$843.00	Arms Group 1 & 4
					Warranty 12 year limited



300  
POUNDS  
CAPACITY

\*For NON In-Stock colors, check with OM Seating for additional pricing details.

Above weights do not include optional arm kits. ; FedEx weight is calculated using FedEx dimensional standards to determine billable weight. ; Pricing and specifications subject to change without notification.



# Patriot Series (PA)

(PA / to be renamed "PAC" in 2024)

Value line | General office

Please see pages 105, 189 – 207 for arm kits, casters, and other options.

average / medium

Model	Description	Value Line	Textile Grade-In	List	Specifications
<b>PA55</b> (aka, PAC55-7a)	<i>Simple Multi-Function (-7a)</i>		Grade 1 / C.O.M.	\$565.00	Overall width 27"
	Pneumatic lift		Grade 2 / Grade-in A	\$585.00	Overall height 38" - 46"
	Tilting backrest		Grade 3 / Grade-in B	\$605.00	Back 20" w x 21" h
	EZ back height adjustment		Grade 4 / Grade-in C	\$625.00	Seat 20.5" w x 18-21.1" d
	Seat tilting		Grade 5 / Grade-in D	\$645.00	Seat height 16.5" - 21.5"
	Seat depth adjustment		Grade 6 / Grade-in E	\$665.00	Travel range (ht.) 3" (back) / 5" (seat)
	55mm multi-surface casters (STD)		LG1 (Evita) / C.O.L.	\$800.00	COM 1 yd.
			LG2 (Lena-LDEL, LLUT, LORC only)*	\$825.00	Carton / FedEx wt 52 lbs / 101 lbs
			LG3 (Vulcano-LMIT, LSTG only)*	\$850.00	Arms Group 1 & 4
					Warranty 12 year limited



300  
POUNDS  
CAPACITY

\*For NON In-Stock colors, check with OM Seating for additional pricing details.

Model	Description	Value Line	Textile Grade-In	List	Specifications
<b>PA66</b> (aka, PAC66)	<i>Management Synchro (-1)</i>		Grade 1 / C.O.M.	\$633.00	Overall width 27"
	Pneumatic lift		Grade 2 / Grade-in A	\$653.00	Overall height 38" - 46"
	EZ back height adjustment		Grade 3 / Grade-in B	\$673.00	Back 20" w x 21" h
	<b>3-stage locking tilt</b>		Grade 4 / Grade-in C	\$693.00	Seat 20.5" w x 18-21.1" d
	<i>Synchronous seat/back tilt</i>		Grade 5 / Grade-in D	\$713.00	Seat height 16.5" - 21.5"
	Seat depth adjustment		Grade 6 / Grade-in E	\$733.00	Travel range (ht.) 3" (back) / 5" (seat)
	Tension knob		LG1 (Evita) / C.O.L.	\$868.00	COM 1 yd.
	55mm multi-surface casters (STD)		LG2 (Lena-LDEL, LLUT, LORC only)*	\$893.00	Carton / FedEx wt 52 lbs / 101 lbs
			LG3 (Vulcano-LMIT, LSTG only)*	\$918.00	Arms Group 1 & 4
					Warranty 12 year limited



300  
POUNDS  
CAPACITY

\*For NON In-Stock colors, check with OM Seating for additional pricing details.

Model	Description	Value Line	Textile Grade-In	List	Specifications
<b>PA57D</b> (aka, PAC57-7a)	<i>Simple Multi-Function (-7a)</i>		Grade 1 / C.O.M.	\$541.00	Overall width 27"
	Pneumatic lift		Grade 2 / Grade-in A	\$561.00	Overall height 37" - 45"
	Tilting backrest		Grade 3 / Grade-in B	\$581.00	Back 19" w x 19" h
	EZ back height adjustment		Grade 4 / Grade-in C	\$601.00	Seat 21" w x 18-21.1" d
	Seat tilting		Grade 5 / Grade-in D	\$621.00	Seat height 17" - 22"
	Seat depth adjustment		Grade 6 / Grade-in E	\$641.00	Travel range (ht.) 3" (back) / 5" (seat)
	55mm multi-surface casters (STD)		LG1 (Evita) / C.O.L.	\$776.00	COM 1 yd.
			LG2 (Lena-LDEL, LLUT, LORC only)*	\$801.00	Carton / FedEx wt 56 lbs / 101 lbs
			LG3 (Vulcano-LMIT, LSTG only)*	\$826.00	Arms Group 1 & 4
					Warranty 12 year limited



300  
POUNDS  
CAPACITY

\*For NON In-Stock colors, check with OM Seating for additional pricing details.

Model	Description	Value Line	Textile Grade-In	List	Specifications
<b>PA67</b> (aka, aka, PAC67)	<i>Management Synchro (-1)</i>		Grade 1 / C.O.M.	\$609.00	Overall width 27"
	Pneumatic lift		Grade 2 / Grade-in A	\$629.00	Overall height 37" - 45"
	EZ back height adjustment		Grade 3 / Grade-in B	\$649.00	Back 19" w x 19" h
	<b>3-stage locking tilt</b>		Grade 4 / Grade-in C	\$669.00	Seat 21" w x 18-21.1" d
	<i>Synchronous seat/back tilt</i>		Grade 5 / Grade-in D	\$689.00	Seat height 17" - 22"
	Seat depth adjustment		Grade 6 / Grade-in E	\$709.00	Travel range (ht.) 3" (back) / 5" (seat)
	Tension knob		LG1 (Evita) / C.O.L.	\$844.00	COM 1 yd.
	55mm multi-surface casters (STD)		LG2 (Lena-LDEL, LLUT, LORC only)*	\$869.00	Carton / FedEx wt 56 lbs / 101 lbs
			LG3 (Vulcano-LMIT, LSTG only)*	\$894.00	Arms Group 1 & 4
					Warranty 12 year limited



300  
POUNDS  
CAPACITY

\*For NON In-Stock colors, check with OM Seating for additional pricing details.

Above weights do not include optional arm kits. ; FedEx weight is calculated using FedEx dimensional standards to determine billable weight. ; Pricing and specifications subject to change without notification.

# Patriot Series (PA)

(PA | to be renamed "PAC" in 2024)

Value line | General office

Please see pages 105, 189 – 207 for arm kits, casters, and other options.

average / medium

Model	Description	Value Line	Textile Grade-In	List	Specifications
<b>PA58</b> (aka, PAC58-7a)	<i>Simple Multi-Function (-7a)</i>		Grade 1 / C.O.M.	\$567.00	Overall width 27"
	Pneumatic lift		Grade 2 / Grade-in A	\$587.00	Overall height 37" - 45"
	Tilting backrest		Grade 3 / Grade-in B	\$607.00	Back 19" w x 19" h
	EZ back height adjustment		Grade 4 / Grade-in C	\$627.00	Seat 21" w x 18-21.1" d
	Seat tilting		Grade 5 / Grade-in D	\$647.00	Seat height 17" - 22"
	Seat depth adjustment		Grade 6 / Grade-in E	\$667.00	Travel range (ht.) 3" (back) / 5" (seat)
	<i>Fabric panel back</i>		LG1 (Evita) / C.O.L.	\$802.00	COM 1.5 yds.
	55mm multi-surface casters (STD)		LG2 (Lena- <b>LDEL, LLUT, LORC</b> only)*	\$827.00	Carton / FedEx wt 56 lbs / 101 lbs
			LG3 (Vulcano- <b>LMIT, LSTG</b> only)*	\$852.00	Arms Group 1 & 4
					Warranty 12 year limited



300  
POUNDS  
CAPACITY

\*For NON In-Stock colors, check with OM Seating for additional pricing details.

Model	Description	Value Line	Textile Grade-In	List	Specifications
<b>PA68</b> (aka, PAC68)	<i>Management Synchro (-1)</i>		Grade 1 / C.O.M.	\$634.00	Overall width 27"
	Pneumatic lift		Grade 2 / Grade-in A	\$654.00	Overall height 37" - 45"
	EZ back height adjustment		Grade 3 / Grade-in B	\$674.00	Back 19" w x 19" h
	<b>3-stage locking tilt</b>		Grade 4 / Grade-in C	\$694.00	Seat 21" w x 18-21.1" d
	<b>Synchronous seat/back tilt</b>		Grade 5 / Grade-in D	\$714.00	Seat height 17" - 22"
	Seat depth adjustment		Grade 6 / Grade-in E	\$734.00	Travel range (ht.) 3" (back) / 5" (seat)
	Tension knob		LG1 (Evita) / C.O.L.	\$869.00	COM 1.5 yds.
	<i>Fabric panel back</i>		LG2 (Lena- <b>LDEL, LLUT, LORC</b> only)*	\$894.00	Carton / FedEx wt 56 lbs / 101 lbs
	55mm multi-surface casters (STD)		LG3 (Vulcano- <b>LMIT, LSTG</b> only)*	\$919.00	Arms Group 1 & 4
					Warranty 12 year limited



300  
POUNDS  
CAPACITY

\*For NON In-Stock colors, check with OM Seating for additional pricing details.

**NOTE:** When upholstered in any Grade 5 patterns (Solids, Architext, and Myth) model #'s PA58 and PA68 back shells are upholstered in a high double-rub black fabric unless otherwise specified (for matching ComfortKnit backshell upholstery, see page 207 for pricing: DUB-K (formerly UPHDUB-T).

Above weights do not include optional arm kits. ; FedEx weight is calculated using FedEx dimensional standards to determine billable weight. ; Pricing and specifications subject to change without notification.

# Patriot Series (PA)

(PA / to be renamed "PAC" in 2024)

Value line | General office

Please see pages 189 – 207 for arm kits, casters, and other options.

large / xtra tall

Model	Description	Value Line	Textile Grade-In	List	Specifications
<b>PA59</b> (aka, PAC59-7a)	<i>Simple Multi-Function (-7a)</i>		Grade 1 / C.O.M.	\$600.00	Overall width 27"
	Pneumatic lift		Grade 2	\$620.00	Overall height 42.5" - 50"
	Tilting backrest		Grade 3 / Grade-in A	\$640.00	Back 20.5" w x 25" h
	EZ back height adjustment		Grade 4 / Grade-in B	\$660.00	Seat 21" w x 18-21.1" d
	Seat tilting		Grade 5 / Grade-in C	\$680.00	Seat height 17" - 22"
	Seat depth adjustment		Grade 6 / Grade-in D	\$700.00	Travel range (ht.) 3" (back) / 5" (seat)
	55mm multi-surface casters (STD)		LG1 (Evita) / C.O.L.	\$870.00	COM 1.5 yds.
			LG2 (Lena-LDEL, LLUT, LORC only)*	\$895.00	Carton / FedEx wt 59 lbs / 101 lbs
			LG3 (Vulcano-LMIT, LSTG only)*	\$920.00	Arms Group 1 & 4
					Warranty 12 year limited



300 POUNDS CAPACITY

\*For NON In-Stock colors, check with OM Seating for additional pricing details.

Model	Description	Value Line	Textile Grade-In	List	Specifications
<b>PA69</b> (aka, PAC69)	<i>Management Synchro (-1)</i>		Grade 1 / C.O.M.	\$666.00	Overall width 27"
	Pneumatic lift		Grade 2	\$686.00	Overall height 42.5" - 50"
	EZ back height adjustment		Grade 3 / Grade-in A	\$706.00	Back 20.5" w x 25" h
	<b>3-stage locking tilt</b>		Grade 4 / Grade-in B	\$726.00	Seat 21" w x 18-21.1" d
	<b>Synchronous seat/back tilt</b>		Grade 5 / Grade-in C	\$746.00	Seat height 17" - 22"
	Seat depth adjustment		Grade 6 / Grade-in D	\$766.00	Travel range (ht.) 3" (back) / 5" (seat)
	Tension knob		LG1 (Evita) / C.O.L.	\$936.00	COM 1.5 yds.
	55mm multi-surface casters (STD)		LG2 (Lena-LDEL, LLUT, LORC only)*	\$961.00	Carton / FedEx wt 59 lbs / 101 lbs
			LG3 (Vulcano-LMIT, LSTG only)*	\$986.00	Arms Group 1 & 4
					Warranty 12 year limited



300 POUNDS CAPACITY

\*For NON In-Stock colors, check with OM Seating for additional pricing details.

side chair

Model	Description	Value Line	Textile Grade-In	List	Specifications
<b>PA61S</b> (aka, PAC61s)	Cantilever Sled base		Grade 1 / C.O.M.	\$362.00	Overall width 22"
			Grade 2 / Grade-in A	\$382.00	Overall height 38.5" (fixed)
			Grade 3 / Grade-in B	\$402.00	Back 20" w x 21" h
			Grade 4 / Grade-in C	\$422.00	Seat 20.5" w x 19" d
			Grade 5 / Grade-in D	\$442.00	Seat height 18" (fixed)
			Grade 6 / Grade-in E	\$462.00	COM 1 yd.
			LG1 (Evita) / C.O.L.	\$597.00	Carton weight 38 pounds
			LG2 (Lena-LDEL, LLUT, LORC only)*	\$622.00	FedEx weight 62 pounds
			LG3 (Vulcano-LMIT, LSTG only)*	\$647.00	Arms Group 1 & 4
					Warranty 12 year limited



\*For NON In-Stock colors, check with OM Seating for additional pricing details.

common options

### Suggested Options for Patriot PA Series

	<b>Arms</b> <b>KR200 (2D Motion)</b> - list: 119.00 Height and width adjustable, removable T-arms with natural grip control.  For specs. and warranty, see page 193.		<b>KR21 (1D Motion)</b> - list: 70.00 Fixed width, turn-knob height adjustable T-arms.  For specs. and warranty, see page 192.
	<b>JR39 (2D Motion)</b> - list: 132.00 Height and width adjustable forward slanting T-arms with soft touch width adjustment trigger.  For specs. and warranty, see page 193.		

Above weights do not include optional arm kits. ; FedEx weight is calculated using FedEx dimensional standards to determine billable weight. ; Pricing and specifications subject to change without notification.

# Patriot Series (PC)

(PA | to be renamed "PAC" in 2024)

General office

Please see pages 107, 189 – 207 for arm kits, casters, and other options.

small / petite

Model	Description	Value Line	Textile Grade-In	List	Specifications
<b>PC53</b> (aka, PAC53-8b)	<i>Full Multi-Function (-8b)</i>		Grade 1 / C.O.M.	\$627.00	Overall width 25"
	Pneumatic lift		Grade 2 / Grade-in A	\$647.00	Overall height 32" - 40"
	Tilting backrest		Grade 3 / Grade-in B	\$667.00	Back 17.5" w x 16.5" h
	EZ back height adjustment		Grade 4 / Grade-in C	\$687.00	Seat 19" w x 17-20.1" d
	Seat tilting		Grade 5 / Grade-in D	\$707.00	Seat height 16" - 21"
	Seat depth adjustment		Grade 6 / Grade-in E	\$727.00	Travel range (ht.) 3" (back) / 5" (seat)
	Rocking tilt		LG1 (Evita) / C.O.L.	\$847.00	COM 1 yd.
	Infinite forward tilting		LG2 (Lena- <b>LDEL, LLUT, LORC only</b> )*	\$872.00	Carton / FedEx wt 54 lbs / 101 lbs
	Tension knob		LG3 (Vulcano- <b>LMIT, LSTG only</b> )*	\$902.00	Arms Group 1 & 4
	55mm multi-surface casters (STD)				Warranty 12 year limited
	*For NON In-Stock colors, check with OM Seating for additional pricing details.				



average / medium

Model	Description	Value Line	Textile Grade-In	List	Specifications
<b>PC55</b> (aka, PAC55-8b)	<i>Full Multi-Function (-8b)</i>		Grade 1 / C.O.M.	\$693.00	Overall width 27"
	Pneumatic lift		Grade 2 / Grade-in A	\$713.00	Overall height 38" - 46"
	Tilting backrest		Grade 3 / Grade-in B	\$733.00	Back 20" w x 21" h
	EZ back height adjustment		Grade 4 / Grade-in C	\$753.00	Seat 20.5" w x 18-21.1" d
	Seat tilting		Grade 5 / Grade-in D	\$773.00	Seat height 16.5" - 21.5"
	Seat depth adjustment		Grade 6 / Grade-in E	\$793.00	Travel range (ht.) 3" (back) / 5" (seat)
	Rocking tilt		LG1 (Evita) / C.O.L.	\$928.00	COM 1 yd.
	Infinite forward tilting		LG2 (Lena- <b>LDEL, LLUT, LORC only</b> )*	\$953.00	Carton / FedEx wt 52 lbs / 101 lbs
	Tension knob		LG3 (Vulcano- <b>LMIT, LSTG only</b> )*	\$978.00	Arms Group 1 & 4
	55mm multi-surface casters (STD)				Warranty 12 year limited
	*For NON In-Stock colors, check with OM Seating for additional pricing details.				



Model	Description	Value Line	Textile Grade-In	List	Specifications
<b>PC57D</b> (aka, PAC57-8b)	<i>Full Multi-Function (-8b)</i>		Grade 1 / C.O.M.	\$669.00	Overall width 27"
	Pneumatic lift		Grade 2 / Grade-in A	\$689.00	Overall height 37" - 45"
	Tilting backrest		Grade 3 / Grade-in B	\$709.00	Back 19" w x 19" h
	EZ back height adjustment		Grade 4 / Grade-in C	\$729.00	Seat 21" w x 17.5-20.6" d
	Seat tilting		Grade 5 / Grade-in D	\$749.00	Seat height 17" - 22"
	Seat depth adjustment		Grade 6 / Grade-in E	\$769.00	Travel range (ht.) 3" (back) / 5" (seat)
	Rocking tilt		LG1 (Evita) / C.O.L.	\$904.00	COM 1 yd.
	Infinite forward tilting		LG2 (Lena- <b>LDEL, LLUT, LORC only</b> )*	\$929.00	Carton / FedEx wt 56 lbs / 101 lbs
	Tension knob		LG3 (Vulcano- <b>LMIT, LSTG only</b> )*	\$954.00	Arms Group 1 & 4
	55mm multi-surface casters (STD)				Warranty 12 year limited
	*For NON In-Stock colors, check with OM Seating for additional pricing details.				



Model	Description	Value Line	Textile Grade-In	List	Specifications
<b>PC58</b> (aka, PAC58-8b)	<i>Full Multi-Function (-8b)</i>		Grade 1 / C.O.M.	\$695.00	Overall width 27"
	Pneumatic lift		Grade 2 / Grade-in A	\$715.00	Overall height 37" - 45"
	Tilting backrest		Grade 3 / Grade-in B	\$735.00	Back 19" w x 19" h
	EZ back height adjustment		Grade 4 / Grade-in C	\$755.00	Seat 21" w x 18-21.1" d
	Seat tilting		Grade 5 / Grade-in D	\$775.00	Seat height 17" - 22"
	Seat depth adjustment		Grade 6 / Grade-in E	\$795.00	Travel range (ht.) 3" (back) / 5" (seat)
	Rocking tilt		LG1 (Evita) / C.O.L.	\$930.00	COM 1.5 yds.
	Infinite forward tilting		LG2 (Lena- <b>LDEL, LLUT, LORC only</b> )*	\$955.00	Carton / FedEx wt 56 lbs / 101 lbs
	Tension knob		LG3 (Vulcano- <b>LMIT, LSTG only</b> )*	\$980.00	Arms Group 1 & 4
	<b>Fabric panel back</b>				Warranty 12 year limited
	55mm multi-surface casters (STD)				
*For NON In-Stock colors, check with OM Seating for additional pricing details.					



**NOTES** When upholstered in any Grade 5 patterns (Solids, Architect, and Myth) the PC58's back shell is upholstered in a high double-rub black fabric unless otherwise specified (for matching ComfortKnit back upholstery, see page 207 for pricing: DUB-K (formerly UPHDUB-T)).

Above weights do not include optional arm kits. ; FedEx weight is calculated using FedEx dimensional standards to determine billable weight. ; Pricing and specifications subject to change without notification.

# Patriot Series (PC)

(PA | to be renamed "PAC" in 2024)

General office

Please see pages 189 – 207 for arm kits, casters, and other options.

large / xtra tall

Model	Description	Value Line	Textile Grade-In	List	Specifications
<b>PC59</b> (aka, PAC59-8b)	<i>Full Multi-Function (-8b)</i>		Grade 1 / C.O.M.	\$727.00	Overall width 27"
	Pneumatic lift		Grade 2	\$747.00	Overall height 42.5" - 50"
	Tilting backrest		Grade 3 / Grade-in A	\$767.00	Back 20.5" w x 25" h
	EZ back height adjustment		Grade 4 / Grade-in B	\$787.00	Seat 21" w x 18-21.1" d
	Seat tilting		Grade 5 / Grade-in C	\$807.00	Seat height 17" - 22"
	Seat depth adjustment		Grade 6 / Grade-in D	\$827.00	Travel range (ht.) 3" (back) / 5" (seat)
	Rocking tilt		LG1 (Evita) / C.O.L.	\$997.00	COM 1.5 yds.
	Infinite forward tilting		LG2 (Lena- <b>LDEL, LLUT, LORC only</b> )*	\$1,022.00	Carton / FedEx wt 59 lbs / 101 lbs
	Tension knob		LG3 (Vulcano- <b>LMIT, LSTG only</b> )*	\$1,047.00	Arms Group 1 & 4
	55mm multi-surface casters (STD)				Warranty 12 year limited



300  
POUNDS  
CAPACITY

\*For NON In-Stock colors, check with OM Seating for additional pricing details.

common options

## Suggested Options for PC Series

### Arms



**KR100M (2D Motion)** (formerly KR240M)  
 - list: 144.00  
 Height and width adjustable, removable T-arms with natural grip control and Memosoft arm pad.  
 For specs and warranty, see page 193.



**KR100-50 (4D+ Motion)** (formerly KR540)  
 - list: 205.00  
 Height and width adjustable, removable T-arms with 6-way ultra adjustable, omni directional arm top (RP-50).  
 For specs. and warranty, see page 196.



**KR100-45 (4D Motion)** (formerly KR445)  
 - list: 185.00  
 Height and width adjustable, removable T-arms with fore-aft, side-side, and inward pivoting arm top (RP-45).  
 For specs. and warranty, see page 194.

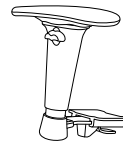

**JR39 (2D Motion)** - list: 132.00  
 Height and width adjustable forward slanting T-arms with soft touch width adjustment trigger.  
 For specs. and warranty, see page 193.

Above weights do not include optional arm kits. ; FedEx weight is calculated using FedEx dimensional standards to determine billable weight. ; Pricing and specifications subject to change without notification.



# Paramount

## Features:

- Begins @ \$688 armless / \$807 with KR200 arms (PT72N)
- PTxx - Value-oriented and fully loaded ergonomic series
- 7xxx - A more executive look (upholstered outer back shells and executive styling)
- Timeless design allows for this long-lasting series to stay current no matter the environment
- Wide range of size options within the series to fit any user "big" to "small"
- Most models standard with adjustable lumbar, seat depth & independently adjustable back/seat



# Paramount (PT)

Value Line | General Office

Please see pages 115, 189 – 207 for arm kits, casters, and other options.

small / petite

Model	Description	Value Line	Textile Grade-In	List	Specifications
PT62	<i>Full Multi-Function (-8a)</i>		Grade 1 / C.O.M.	\$714.00	Overall width 25"
	Pneumatic lift		Grade 2 / Grade-in A	\$734.00	Overall height 32.5" - 38.5"
	Tilting backrest		Grade 3 / Grade-in B	\$754.00	Back 17" w x 16" h
	EZ back height adjustment		Grade 4 / Grade-in C	\$774.00	Seat 19" w x 16-19.1" d
	Rocking tilt		Grade 5 / Grade-in D	\$794.00	Seat height 15.5" - 19.5"
	Seat tilting		Grade 6 / Grade-in E	\$814.00	Travel range (ht.) 4" (back) / 4" (seat)
	Seat depth adjustment		LG1 (Evita) / C.O.L.	\$934.00	COM 1 yd.
	Forward tilting		LG2 (Lena-LDEL, LLUT, LORC only)*	\$959.00	Carton / FedEx wt 54 lbs / 101 lbs
	Tension knob		LG3 (Vulcano-LMIT, LSTG only)*	\$989.00	Arms Group 1 & 4
	Extra-low cylinder				Warranty 12 year limited
	55mm multi-surface casters (STD)				
				*For NON In-Stock colors, check with OM Seating for additional pricing details.	



300 POUNDS CAPACITY

Model	Description	Value Line	Textile Grade-In	List	Specifications
PT69	<i>Full Multi-Function (-8a)</i>		Grade 1 / C.O.M.	\$810.00	Overall width 25"
	Pneumatic lift		Grade 2 / Grade-in A	\$830.00	Overall height 40" - 49"
	Tilting backrest		Grade 3 / Grade-in B	\$850.00	Back 17" w x 22" h
	EZ back height adjustment		Grade 4 / Grade-in C	\$870.00	Seat 19" w x 15.5-18.6" d
	Rocking tilt		Grade 5 / Grade-in D	\$890.00	Seat height 17" - 22"
	Seat tilting		Grade 6 / Grade-in E	\$910.00	Travel range (ht.) 4" (back) / 5" (seat)
	Seat depth adjustment		LG1 (Evita) / C.O.L.	\$1,045.00	COM 1 yd.
	Adjustable lumbar		LG2 (Lena-LDEL, LLUT, LORC only)*	\$1,070.00	Carton / FedEx wt 58 lbs / 101 lbs
	Forward tilting		LG3 (Vulcano-LMIT, LSTG only)*	\$1,095.00	Arms Group 1 & 4
	Tension knob				Warranty 12 year limited
	55mm multi-surface casters (STD)				
				*For NON In-Stock colors, check with OM Seating for additional pricing details.	



300 POUNDS CAPACITY

## Additional Mechanism Options for PT62 and PT69

Append -4a, -4b, -2 to PT models above. Ex. PT69-4a, PT69-4b etc.

### -4a Quick-Adjust Synchro (Simple) - list: no upcharge

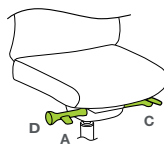

- A. Seat Height
- B. Seat Slider
- C. 5 Tilt Range Limiter Positions
- D. 7 Tilt Tension Quick Adjust Setting

### -4b Quick-Adjust Synchro (Advanced) - list: upcharge \$50.00

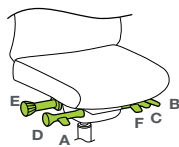

- A. Seat Height
- B. Seat Slider
- C. 5 Tilt Range Limiter Positions
- D. 7 Tilt Tension Quick Adjust Settings
- E. Independent Back Angle
- F. Forward Seat Angle (for perching & back relief)

### -2 Executive Synchro (formerly -RV) - list: upcharge \$30.00

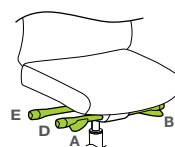

- A. Seat Height
- B. Seat Slider
- D. Side Mounted Tilt Tension (telescopes out/in)
- E. Independent Back Angle

**NOTE:** seat depth range is 0.6" less with this mechanism

Above weights do not include optional arm kits. ; FedEx weight is calculated using FedEx dimensional standards to determine billable weight. ; Pricing and specifications subject to change without notification.



# Paramount (PT)

Value Line | General Office

Please see pages 115, 189 – 207 for arm kits, casters, and other options.

average / medium

Model	Description	Value Line	Textile Grade-In	List	Specifications
PT72N	<i>Full Multi-Function (-8b)</i>		Grade 1 / C.O.M.	\$688.00	Overall width 27"
	Pneumatic lift		Grade 2 / Grade-in A	\$708.00	Overall height 35" - 44"
	Tilting backrest		Grade 3 / Grade-in B	\$728.00	Back 17" w x 18" h
	EZ back height adjustment		Grade 4 / Grade-in C	\$748.00	Seat 20" w x 17-20.1" d
	Rocking tilt		Grade 5 / Grade-in D	\$768.00	Seat height 17" - 22"
	Seat tilting		Grade 6 / Grade-in E	\$788.00	Travel range (ht.) 4" (back) / 5" (seat)
	Seat depth adjustment		LG1 (Evita) / C.O.L.	\$923.00	COM 1 yd.
	Infinite forward tilting		LG2 (Lena-LDEL, LLUT, LORC only)*	\$948.00	Carton / FedEx wt 45 lbs / 101 lbs
	Tension knob		LG3 (Vulcano-LMIT, LSTG only)*	\$973.00	Arms Group 1 & 4
	55mm multi-surface casters (STD)				Warranty 12 year limited



300 POUNDS CAPACITY

\*For NON In-Stock colors, check with OM Seating for additional pricing details.

Model	Description	Value Line	Textile Grade-In	List	Specifications
PT74	<i>Full Multi-Function (-8a)</i>		Grade 1 / C.O.M.	\$819.00	Overall width 27"
	Pneumatic lift		Grade 2 / Grade-in A	\$839.00	Overall height 35" - 44"
	Tilting backrest		Grade 3 / Grade-in B	\$859.00	Back 17" w x 18" h
	EZ back height adjustment		Grade 4 / Grade-in C	\$879.00	Seat 20" w x 17-20.1" d
	Rocking tilt		Grade 5 / Grade-in D	\$899.00	Seat height 17" - 22"
	Seat tilting		Grade 6 / Grade-in E	\$919.00	Travel range (ht.) 4" (back) / 5" (seat)
	Seat depth adjustment		LG1 (Evita) / C.O.L.	\$1,054.00	COM 1 yd.
	Adjustable lumbar		LG2 (Lena-LDEL, LLUT, LORC only)*	\$1,079.00	Carton / FedEx wt 53 lbs / 101 lbs
	Forward tilting		LG3 (Vulcano-LMIT, LSTG only)*	\$1,104.00	Arms Group 1 & 4
	Tension knob				Warranty 12 year limited
	55mm multi-surface casters (STD)				



300 POUNDS CAPACITY

\*For NON In-Stock colors, check with OM Seating for additional pricing details.

## Additional Mechanism Options for PT74

Append -4a, -4b, -2 to PT models above. Ex. PT74-4b etc.

### -4a Quick-Adjust Synchro (Simple) - list: no upcharge

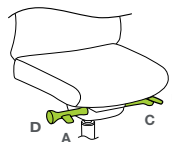

- A. Seat Height
- B. Seat Slider
- C. 5 Tilt Range Limiter Positions
- D. 7 Tilt Tension Quick Adjust Setting

### -4b Quick-Adjust Synchro (Advanced) - list: upcharge \$50.00

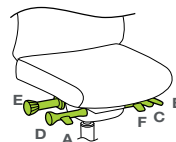

- A. Seat Height
- B. Seat Slider
- C. 5 Tilt Range Limiter Positions
- D. 7 Tilt Tension Quick Adjust Settings
- E. Independent Back Angle
- F. Forward Seat Angle (for perching & back relief)

### -2 Executive Synchro (formerly -RV) - list: upcharge \$30.00

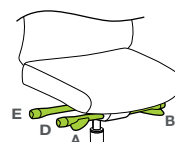

- A. Seat Height
- B. Seat Slider
- D. Side Mounted Tilt Tension (telescopes out/in)
- E. Independent Back Angle

NOTE: seat depth range is 0.6" less with this mechanism

Above weights do not include optional arm kits. ; FedEx weight is calculated using FedEx dimensional standards to determine billable weight. ; Pricing and specifications subject to change without notification.

# Paramount (PT)

Value Line | General Office

Please see pages 115, 189 – 207 for arm kits, casters, and other options.

large / xtra tall

Model	Description	Value Line	Textile Grade-In	List	Specifications
 <b>PT76N</b>	<i>Full Multi-Function (-8b)</i>		Grade 1 / C.O.M.	\$764.00	Overall width 27"
	Pneumatic lift		Grade 2 / Grade-in A	\$784.00	Overall height 37.5" - 48"
	Tilting backrest		Grade 3 / Grade-in B	\$804.00	Back 19.5" w x 22" h
	EZ back height adjustment		Grade 4 / Grade-in C	\$824.00	Seat 21" w x 18-21.1" d
	Rocking tilt		Grade 5 / Grade-in D	\$844.00	Seat height 17" - 22"
	Seat tilting		Grade 6 / Grade-in E	\$864.00	Travel range (ht.) 4" (back) / 5" (seat)
	Seat depth adjustment		LG1 (Evita) / C.O.L.	\$999.00	COM 1.5 yds.
	Infinite forward tilting		LG2 (Lena- <b>LDEL, LLUT, LORC only</b> )*	\$1024.00	Carton / FedEx wt 50 lbs / 101 lbs
	Tension knob		LG3 (Vulcano- <b>LMIT, LSTG only</b> )*	\$1,049.00	Arms Group 1 & 4
	55mm multi-surface casters (STD)				Warranty 12 year limited
	*For NON In-Stock colors, check with OM Seating for additional pricing details.				

Model	Description	Value Line	Textile Grade-In	List	Specifications
 <b>PT78</b>	<i>Full Multi-Function (-8a)</i>		Grade 1 / C.O.M.	\$895.00	Overall width 27"
	Pneumatic lift		Grade 2 / Grade-in A	\$915.00	Overall height 40" - 48"
	Tilting backrest		Grade 3 / Grade-in B	\$935.00	Back 19.5" w x 22" h
	EZ back height adjustment		Grade 4 / Grade-in C	\$955.00	Seat 21" w x 18-21.1" d
	Rocking tilt		Grade 5 / Grade-in D	\$975.00	Seat height 17" - 22"
	Seat tilting		Grade 6 / Grade-in E	\$995.00	Travel range (ht.) 4" (back) / 5" (seat)
	Seat depth adjustment		LG1 (Evita) / C.O.L.	\$1,130.00	COM 1.5 yds.
	Adjustable lumbar		LG2 (Lena- <b>LDEL, LLUT, LORC only</b> )*	\$1,155.00	Carton / FedEx wt 57 lbs / 101 lbs
	Forward tilting		LG3 (Vulcano- <b>LMIT, LSTG only</b> )*	\$1,180.00	Arms Group 1 & 4
	Tension knob				Warranty 12 year limited
	55mm multi-surface casters (STD)				
	*For NON In-Stock colors, check with OM Seating for additional pricing details.				

## Additional Mechanism Options for PT78

Append -4a, -4b, -2 to PT models above. Ex. PT78-4b etc.

### -4a Quick-Adjust Synchro (Simple) - list: no upcharge

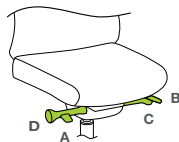

- A. Seat Height
- B. Seat Slider
- C. 5 Tilt Range Limiter Positions
- D. 7 Tilt Tension Quick Adjust Setting

### -4b Quick-Adjust Synchro (Advanced) - list: upcharge \$50.00

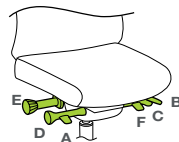

- A. Seat Height
- B. Seat Slider
- C. 5 Tilt Range Limiter Positions
- D. 7 Tilt Tension Quick Adjust Settings
- E. Independent Back Angle
- F. Forward Seat Angle (for perching & back relief)

### -2 Executive Synchro (formerly -RV) - list: upcharge \$30.00

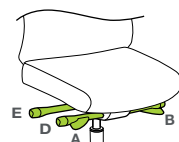

- A. Seat Height
- B. Seat Slider
- D. Side Mounted Tilt Tension (telescopes out/in)
- E. Independent Back Angle

**NOTE:** seat depth range is 0.6" less with this mechanism

Above weights do not include optional arm kits. ; FedEx weight is calculated using FedEx dimensional standards to determine billable weight. ; Pricing and specifications subject to change without notification.

# Paramount (PT)

Value Line | General Office

Please see pages 115, 189 – 207 for arm kits, casters, and other options.

large / xtra tall

Model	Description	Value Line	Textile Grade-In	List	Specifications
<b>PT79</b> 	<i>Full Multi-Function (-8a)</i>		Grade 1 / C.O.M.	\$966.00	Overall width 27"
	Pneumatic lift		Grade 2	\$991.00	Overall height 46" - 55"
	Tilting backrest		Grade 3 / Grade-in A	\$1,016.00	Back 19.5" w x 28" h
	EZ back height adjustment		Grade 4 / Grade-in B	\$1,041.00	Seat 21" w x 18-21.1" d
	Rocking tilt		Grade 5 / Grade-in C	\$1,066.00	Seat height 17" - 22"
	Seat tilting		Grade 6 / Grade-in D	\$1,091.00	Travel range (ht.) 4" (back) / 5" (seat)
	Seat depth adjustment		LG1 (Evita) / C.O.L.	\$1,251.00	COM 1.5 yds.
	Adjustable lumbar		LG2 (Lena-LDEL, LLUT, LORC only)*	\$1,276.00	Carton / FedEx wt 63 lbs / 195 lbs
	Forward tilting		LG3 (Vulcano-LMIT, LSTG only)*	\$1,311.00	Arms Group 1 & 4
	Tension knob				Warranty 12 year limited
	55mm multi-surface casters (STD)				

\*For NON In-Stock colors, check with OM Seating for additional pricing details.

Model	Description	Textile Grade-In	List	Specifications
<b>PTYM</b> 	<i>Full Multi-Function (-8a)</i>	Grade 1 / C.O.M.	\$1,329.00	Overall width 28"
	Pneumatic lift	Grade 2	\$1,354.00	Overall height 41" - 51"
	Tilting backrest	Grade 3 / Grade-in A	\$1,379.00	Back 19.5" w x 22" h
	EZ back height adjustment	Grade 4 / Grade-in B	\$1,404.00	Seat 23.5" w x 20.5-23.6" d
	Rocking tilt	Grade 5 / Grade-in C	\$1,429.00	Seat height 19" - 25"
	Seat tilting	Grade 6 / Grade-in D	\$1,454.00	Travel range (ht.) 4" (back) / 6" (seat)
	Seat depth adjustment	LG1 (Evita) / C.O.L.	\$1,614.00	COM 1.5 yds.
	Adjustable lumbar	LG2 (Lena-LDEL, LLUT, LORC only)*	\$1,639.00	Carton / FedEx wt 60 lbs / 195 lbs
	Forward tilting	LG3 (Vulcano-LMIT, LSTG only)*	\$1,674.00	Arms Group 1 & 4
	Tension knob			Warranty 12 year limited
	Memory foam in seat			
Dual-tone universal soft casters				

\*For NON In-Stock colors, check with OM Seating for additional pricing details.

Model	Description	Textile Grade-In	List	Specifications
<b>PTYM-XT</b> 	<i>Full Multi-Function (-8a)</i>	Grade 1 / C.O.M.	\$1,390.00	Overall width 28"
	Pneumatic lift	Grade 2	\$1,415.00	Overall height 47" - 58"
	<i>Tilting backrest (PT79 size)</i>	Grade 3 / Grade-in A	\$1,440.00	Back 19.5" w x 28" h
	EZ back height adjustment	Grade 4 / Grade-in B	\$1,465.00	Seat 23.5" w x 20.5-23.6" d
	Rocking tilt	Grade 5 / Grade-in C	\$1,490.00	Seat height 19" - 25"
	Seat tilting	Grade 6 / Grade-in D	\$1,515.00	Travel range (ht.) 4" (back) / 6" (seat)
	Seat depth adjustment	LG1 (Evita) / C.O.L.	\$1,700.00	COM 1.5 yds.
	Adjustable lumbar	LG2 (Lena-LDEL, LLUT, LORC only)*	\$1,725.00	Carton / FedEx wt 60 lbs / 195 lbs
	Forward tilting	LG3 (Vulcano-LMIT, LSTG only)*	\$1,760.00	Arms Group 1 & 4
	Tension knob			Warranty 12 year limited
	Memory foam in seat			
Dual-tone universal soft casters				

\*For NON In-Stock colors, check with OM Seating for additional pricing details.



Above weights do not include optional arm kits. ; FedEx weight is calculated using FedEx dimensional standards to determine billable weight. ; Pricing and specifications subject to change without notification.

# Paramount (PT)

Value Line | General Office



Please see pages 115, 189 – 207 for arm kits, casters, and other options.

guest chairs / nesting

Model	Description	Value Line	Textile Grade-In	List	Specifications
PT70N	Convenient nesting chair design		Grade 1 / C.O.M.	\$468.00	Overall width 24"
	Upholstered backrest		Grade 2 / Grade-in A	\$488.00	Overall height 39" (fixed)
 	Fixed arms standard		Grade 3 / Grade-in B	\$508.00	Back 17" w x 18" h
	Black Powdercoat frame (standard)		Grade 4 / Grade-in C	\$528.00	Seat 18.5" w x 18.5" d
	Silver Powdercoat frame (option)		Grade 5 / Grade-in D	\$548.00	Seat height 18" (fixed)
			Grade 6 / Grade-in E	\$568.00	COM 1 yd.
			LG1 (Evita) / C.O.L.	\$703.00	Carton weight 40 pounds
			LG2 (Lena-LDEL, LLUT, LORC only)*	\$728.00	FedEx weight 85 pounds
			LG3 (Vulcano-LMIT, LSTG only)*	\$753.00	Arms Included
					Warranty 12 year limited

No upcharge for Silver frame option  
Add -SLR after model #  
Ships with back detached.

\*For NON In-Stock colors, check with OM Seating for additional pricing details.

Model	Description	Value Line	Textile Grade-In	List	Specifications
PT71N	Convenient nesting chair design		Grade 1 / C.O.M.	\$462.00	Overall width 22.5"
	Upholstered backrest		Grade 2 / Grade-in A	\$482.00	Overall height 39" (fixed)
 	Armless		Grade 3 / Grade-in B	\$502.00	Back 17" w x 18" h
	Black Powdercoat frame (standard)		Grade 4 / Grade-in C	\$522.00	Seat 18.5" w x 18.5" d
	Silver Powdercoat frame (option)		Grade 5 / Grade-in D	\$542.00	Seat height 18" (fixed)
			Grade 6 / Grade-in E	\$562.00	COM 1 yd.
			LG1 (Evita) / C.O.L.	\$697.00	Carton weight 40 pounds
			LG2 (Lena-LDEL, LLUT, LORC only)*	\$722.00	FedEx weight 85 pounds
			LG3 (Vulcano-LMIT, LSTG only)*	\$747.00	Arms none
					Warranty 12 year limited

No upcharge for Silver frame option  
Add -SLR after model #  
Ships with back detached.

\*For NON In-Stock colors, check with OM Seating for additional pricing details.

Model	Description	Value Line	Textile Grade-In	List	Specifications
PT74S	Cantilever Sled base		Grade 1 / C.O.M.	\$368.00	Overall width 20"
	Armless		Grade 2 / Grade-in A	\$388.00	Overall height 38" (fixed)
			Grade 3 / Grade-in B	\$408.00	Back 17" w x 18" h
			Grade 4 / Grade-in C	\$428.00	Seat 19" w x 19" d
			Grade 5 / Grade-in D	\$448.00	Seat height 18" (fixed)
			Grade 6 / Grade-in E	\$468.00	COM 1 yd.
			LG1 (Evita) / C.O.L.	\$603.00	Carton weight 35 pounds
			LG2 (Lena-LDEL, LLUT, LORC only)*	\$628.00	FedEx weight 68 pounds
			LG3 (Vulcano-LMIT, LSTG only)*	\$653.00	Arms Group 1 & 4
					Warranty 12 year limited

\*For NON In-Stock colors, check with OM Seating for additional pricing details.

Model	Description	Value Line	Textile Grade-In	List	Specifications
PT76S	Cantilever Sled base		Grade 1 / C.O.M.	\$349.00	Overall width 24"
	Armless		Grade 2 / Grade-in A	\$369.00	Overall height 41" (fixed)
			Grade 3 / Grade-in B	\$389.00	Back 19" w x 21" h
			Grade 4 / Grade-in C	\$409.00	Seat 20" w x 20" d
			Grade 5 / Grade-in D	\$429.00	Seat height 18" (fixed)
			Grade 6 / Grade-in E	\$449.00	COM 1.5 yds.
			LG1 (Evita) / C.O.L.	\$584.00	Carton weight 41 pounds
			LG2 (Lena-LDEL, LLUT, LORC only)*	\$609.00	FedEx weight 100 pounds
			LG3 (Vulcano-LMIT, LSTG only)*	\$634.00	Arms Group 1 & 4
					Warranty 12 year limited

\*For NON In-Stock colors, check with OM Seating for additional pricing details.

Above weights do not include optional arm kits. ; FedEx weight is calculated using FedEx dimensional standards to determine billable weight. ; Pricing and specifications subject to change without notification.

# Paramount (PT)

Value Line | General Office

Please see pages 115, 189 – 207 for arm kits, casters, and other options.

guest chairs / nesting

Model	Description	Value Line	Textile Grade-In	List	Specifications
PT78S	Cantilever Sled base		Grade 1 / C.O.M.	\$404.00	Overall width 24"
	Standard closed loop arms		Grade 2 / Grade-in A	\$424.00	Overall height 41" (fixed)
			Grade 3 / Grade-in B	\$444.00	Back 19" w x 21" h
			Grade 4 / Grade-in C	\$464.00	Seat 20" w x 20" d
			Grade 5 / Grade-in D	\$484.00	Seat height 18" (fixed)
			Grade 6 / Grade-in E	\$504.00	COM 1.5 yds.
			LG1 (Evita) / C.O.L.	\$639.00	Carton weight 41 pounds
			LG2 (Lena-LDEL, LLUT, LORC only)*	\$664.00	FedEx weight 100 pounds
			LG3 (Vulcano-LMIT, LSTG only)*	\$689.00	Arms Included
	Warranty			12 year limited	







300 POUNDS CAPACITY

Note: Arms cannot be removed.

\*For NON In-Stock colors, check with OM Seating for additional pricing details.

common options

## Suggested Options for Paramount Series (PT)

Arms	Description	List
	<b>KR200 (2D Motion)</b> - list: 119.00 Height and width adjustable, removable T-arms with natural grip control. For specs. and warranty, see page 193.	
	<b>KR300 (2D Motion)</b> - list: 144.00 Height and width adjustable, removable T-arms with natural grip control. For specs. and warranty, see page 193.	
	<b>KR100-45 (4D Motion)</b> (formerly KR445) - list: 185.00 Height and width adjustable, removable T-arms with fore-aft, side-side, and inward pivoting arm top (RP-45). For specs. and warranty, see page 194.	
	<b>JR69 (4D Motion)</b> - list: 196.00 Height and width adjustable, forward slanting T-arm with soft touch width adjustment trigger, lockable arm top, fore-aft, side-side, pivoting arm top (RP-65). For specs. and warranty, see page 194.	
	<b>KR25 (1D Motion)</b> - list: 70.00 Fixed width, height adjustable T-arms featuring natural grip control. For specs. and warranty, see page 192.	



Above weights do not include optional arm kits. ; FedEx weight is calculated using FedEx dimensional standards to determine billable weight. ; Pricing and specifications subject to change without notification.



# Paramount (7xxx)

General Office

Please see pages 117, 189 – 207 for arm kits, casters, and other options.

average / medium

Model	Description	Textile Grade-In	List	Specifications	
 	7770	<i>Full Multi-Function (-8a)</i>	Grade 1 / C.O.M.	\$789.00	Overall width 27"
	Pneumatic lift	Grade 2	\$809.00	Overall height 39" - 48"	
	EZ back height adjustment	Grade 3 / Grade-in A	\$829.00	Back 18" w x 21" h	
	Tilting backrest	Grade 4 / Grade-in B	\$849.00	Seat 20" w x 17.5-20.6" d	
	Tilting seat	Grade 5 / Grade-in C	\$869.00	Seat height 17" - 22"	
	Seat depth adjustment	Grade 6 / Grade-in D	\$889.00	Travel range (ht.) 4" (back) / 5" (seat)	
	Swivel/rocking tilt	LG1 (Evita) / C.O.L.	\$1,059.00	COM 1.5 yds.	
	Tension knob	LG2 (Lena-LDEL, LLUT, LORC only)*	\$1,084.00	Carton / FedEx wt 45 lbs / 101 lbs	
	Fabric panel back	LG3 (Vulcano-LMIT, LSTG only)*	\$1,109.00	Arms Group 1 & 4	
	Tilt lock at any angle			Warranty 12 year limited	
	55mm multi-surface casters (STD)				
	*For NON In-Stock colors, check with OM Seating for additional pricing details.				

Model	Description	Textile Grade-In	List	Specifications	
 	7780	<i>Full Multi-Function (-8a)</i>	Grade 1 / C.O.M.	\$872.00	Overall width 27"
	Pneumatic lift	Grade 2	\$892.00	Overall height 39" - 48"	
	EZ back height adjustment	Grade 3 / Grade-in A	\$912.00	Back 18" w x 21" h	
	Tilting backrest	Grade 4 / Grade-in B	\$932.00	Seat 20" w x 17.5-20.6" d	
	Tilting seat	Grade 5 / Grade-in C	\$952.00	Seat height 17" - 22"	
	Seat depth adjustment	Grade 6 / Grade-in D	\$972.00	Travel range (ht.) 4" (back) / 5" (seat)	
	Swivel/rocking tilt	LG1 (Evita) / C.O.L.	\$1,142.00	COM 1.5 yds.	
	Tension knob	LG2 (Lena-LDEL, LLUT, LORC only)*	\$1,167.00	Carton / FedEx wt 48 lbs / 101 lbs	
	Fabric panel back	LG3 (Vulcano-LMIT, LSTG only)*	\$1,192.00	Arms Group 1 & 4	
	Tilt lock at any angle			Warranty 12 year limited	
	Adjustable lumbar				
	55mm multi-surface casters (STD)				
	*For NON In-Stock colors, check with OM Seating for additional pricing details.				

**NOTES** When upholstered in any Grade 5 patterns (Solids, Architext, and Myth) Paramount Series back shells are upholstered in a high double-rub black fabric unless otherwise specified (for matching ComfortKnit backshell upholstery see page 207 for pricing: DUB-K (formerly UPHDUB-T).

Above weights do not include optional arm kits. ; FedEx weight is calculated using FedEx dimensional standards to determine billable weight. ; Pricing and specifications subject to change without notification.

# Paramount (7xxx)

## General Office

Please see pages 189 – 207 for arm kits, casters, and other options.

large / xtra tall

### Model

7878



300  
POUNDS  
CAPACITY

### Description

*Full Multi-Function (-8a)*  
Pneumatic lift  
EZ back height adjustment  
Tilting backrest  
Tilting seat  
Seat depth adjustment  
Adjustable lumbar  
Swivel/rocking tilt  
Forward tilting  
Tension knob  
TLC seat  
55mm multi-surface casters (STD)

### Textile Grade-In

Grade 1 / C.O.M. \$998.00  
Grade 2 \$1,018.00  
Grade 3 / Grade-in A \$1,038.00  
Grade 4 / Grade-in B \$1,058.00  
Grade 5 / Grade-in C \$1,078.00  
Grade 6 / Grade-in D \$1,098.00  
LG1 (Evita) / C.O.L. \$1,283.00  
LG2 (Lena-LDEL, LLUT, LORC only)\* \$1,308.00  
LG3 (Vulcano-LMIT, LSTG only)\* \$1,343.00

### List

\*For NON In-Stock colors, check with OM Seating for additional pricing details.

### Specifications

Overall width 27"  
Overall height 40" - 49"  
Back 18" w x 23" h  
Seat 21" w x 18-21.1" d  
Seat height 17" - 22"  
Travel range (ht.) 4" (back) / 5" (seat)  
COM 1.5 yds.  
Carton / FedEx wt 55 lbs / 101 lbs  
Arms Group 1 & 4  
Warranty 12 year limited

TLC TECHNOLOGY  
TWO LAYER COMFORT

common options

### Suggested Options for Paramount Series

#### Arms



**JR39M (2D Motion)** - list: 169.00  
Height and width adjustable forward slanting T-arms with soft touch width adjustment trigger and Memosoft arm pads.

For specs. and warranty, see page 193.



**JR49 (4D Motion)** - list: 196.00  
Height and width adjustable, forward slanting T-arms with soft touch width adjustment trigger, fore-aft, side-side and inward pivoting arm top (RP-45).

For specs. and warranty, see page 194.



**KR100-45 (4D Motion)** (formerly KR445)  
- list: 185.00  
Height and width adjustable, removable T-arms with fore-aft, side-side, and inward pivoting arm top (RP-45).

For specs. and warranty, see page 194.



**JR69 (4D Motion)** - list: 196.00  
Height and width adjustable, forward slanting T-arm with soft touch width adjustment trigger, lockable arm top, fore-aft, side-side, pivoting arm top (RP-65).

For specs. and warranty, see page 194.

Above weights do not include optional arm kits. ; FedEx weight is calculated using FedEx dimensional standards to determine billable weight. ; Pricing and specifications subject to change without notification.





# Plot Twist™

## Features:

- Upholstered Swivel Seat
- User in Seat: Weight Rating = 300 lbs.
- Objects on Tablet: Weight Rating = 100 lbs.
- 12-year Limited Warranty



Gold Seating Stools



Innovation Seating Stools



Innovation Collections for Collaborations



Business Innovation Award



Best in Show EDspaces Product Innovation



HiP Finalist



Healthcare Design



Chicago Athenaeum Museum of Art & Design





# Plot Twist™ Pouf (PLT-)

Collaborative seating

### Plot Twist Core Features:

- Upholstered Swivel Seat
- 300 lb. Weight Capacity
- 12-year Limited Warranty

**Note:** Green font color indicates default build for "most popular" configuration of this spread.

1. Model	
Code	List
<b>PLT-</b>	<b>\$899</b>

2. Seat Top Upholstery Option Fabric Application Testing Required	
Code	List
• <b>Grade 1 / C.O.M.</b>	<b>\$0</b>
• <b>Grade 2 / Grade-in A</b>	<b>+\$10</b>
• <b>Grade 3 / Grade-in B</b>	<b>+\$20</b>
• <b>Grade 4 / Grade-in C</b>	<b>+\$30</b>
• <b>Grade 5 / Grade-in D</b>	<b>+\$40</b>
• <b>Grade 6 / Grade-in E</b>	<b>+\$50</b>
• <b>Wersy Quilt</b>	<b>+\$45</b>
• <b>LG1 Evita / C.O.L.</b>	<b>+\$22</b>
• <b>LG2 Lena - LDEL, LLUT, LORC only*</b>	<b>+\$25</b>
• <b>LG3 Vulcano - LMIT, LSTG only*</b>	<b>+\$27</b>

Note: Fabric application testing is required for Grade-in and COM materials. Due to trilobe seat shape, patterns will not align. We recommend Solid and Solid Texture textiles.

\*For NON In-Stock colors, check with OM Seating for additional pricing details.

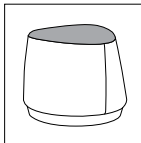

3. Side Panel Upholstery Option Fabric Application Testing Required	
Code	List
• <b>Grade 1 / C.O.M.</b>	<b>\$0</b>
• <b>Grade 2 / Grade-in A</b>	<b>+\$20</b>
• <b>Grade 3 / Grade-in B</b>	<b>+\$40</b>
• <b>Grade 4 / Grade-in C</b>	<b>+\$60</b>
• <b>Grade 5 / Grade-in D</b>	<b>+\$80</b>
• <b>Grade 6 / Grade-in E</b>	<b>+\$100</b>
• <b>LG1 Evita / C.O.L.</b>	<b>+\$67</b>
• <b>LG2 Lena - LDEL, LLUT, LORC only*</b>	<b>+\$75</b>
• <b>LG3 Vulcano - LMIT, LSTG only*</b>	<b>+\$82</b>

Note: Fabric application testing is required for Grade-in and COM materials. Due to trilobe seat shape, patterns will not align. We recommend Solid and Solid Texture textiles.

\*For NON In-Stock colors, check with OM Seating for additional pricing details.

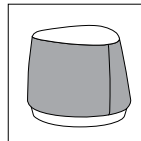

4. Retractable Rope Pull Handle Color	List
<b>-NR</b> No Rope	<b>+\$0</b>
<b>Standard Rope Colors</b>	
<b>-GR09</b> Stone Grey (matches GR01 Finish)	<b>+\$45</b>
<b>-GR10</b> Space Grey (matches GR04 Finish)	<b>+\$45</b>
<b>Premium Colors</b>	
<b>-BK03</b> Onyx Black	<b>+\$55</b>
<b>-GR11</b> Silver	<b>+\$55</b>
<b>-BR02</b> Khaki	<b>+\$55</b>
<b>-OR02</b> Bright Orange	<b>+\$55</b>
<b>-RD05</b> Bright Red	<b>+\$55</b>
<b>-RD06</b> Burnt Cherry	<b>+\$55</b>
<b>-VT01</b> Violet	<b>+\$55</b>
<b>-BL05</b> Ash Blue	<b>+\$55</b>
<b>-BL06</b> Regal Blue	<b>+\$55</b>
<b>-GN05</b> Hunter Green	<b>+\$55</b>
<b>-GN06</b> Kelly Green	<b>+\$55</b>

Note: Add "F-" for the Fixed rope version.

### OTHER OPTIONS (append to above nomenclature to add to, or override existing options)

Casters		
Code		List
 <b>-55C</b> 55mm Carpet Caster		<b>\$24</b>
 <b>-50SS</b> 50mm Safety Soft caster, minimizes chair movement when <b>NOT</b> in use		<b>\$30</b>
 <b>-50R</b> 50mm Reverse Brak- ing caster, restricts chair movement when chair <b>IS</b> in use		<b>\$42</b>

## ORDER NOMENCLATURE

Example: **PLT** — **3104** — **3104** — **NR** — **GR01** — **55MS**

Model #    Seat    Side    Rope    Base    Casters/  
              Uph    Uph    Handle    Finish    Glide

5. Base Finishes		6. Casters / Glide	
Code	List	Code	List
<b>-GR01</b> Palladium Grey	<b>+\$0</b>	<b>-55MS</b> 55mm Multi-Surface Casters	<b>+\$0</b>
<b>-GR04</b> Graphite	<b>+\$0</b>	<b>-GLD</b> Glide Base	<b>+\$52</b>

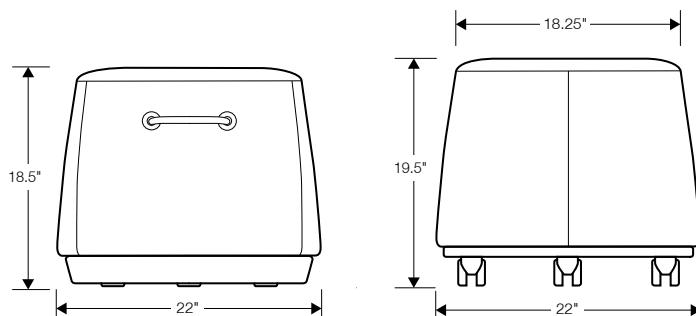

Dimensions	W	D	H
Overall (w/ glide base)	22"	22"	18.5"
Overall (w/ casters)	22"	22"	19.5"
Seat	18.25"	18.25"	18.25"
Back	N/A	N/A	N/A

Upholstery	Back	Pouf
COM*	N/A	1.5 yd.
Shipping	Carton Wt.	FedEx Wt.
	48 lbs.	101 lbs.

\*For big pattern repeats, check with OM



# Plot Twist™ with Tablet (PLT-T)

Collaborative seating

### Plot Twist Core Features:

- Upholstered Swivel Seat
- User in Seat: Weight Rating = 300 lbs.max
- Objects on Tablet: Weight Rating = 100 lbs. max
- 12-year Limited Warranty

**Note:** Green font color indicates default build for "most popular" configuration of this spread.

1. Model		2. Seat Top Upholstery Option Fabric Application Testing Required		3. Side Panel Upholstery Option Fabric Application Testing Required	
Code	List	Code	List	Code	List
<b>PLT-T</b> Plot Twist with Adjustable Height Tablet	<b>\$1,687</b>	• <b>Grade 1 / C.O.M.</b>	<b>\$0</b>	• <b>Grade 1 / C.O.M.</b>	<b>\$0</b>
<b>PLT-TF</b> Plot Twist with Fixed Height Tablet	<b>\$1,559</b>	• <b>Grade 2 / Grade-in A</b>	<b>+\$10</b>	• <b>Grade 2 / Grade-in A</b>	<b>+\$20</b>
		• <b>Grade 3 / Grade-in B</b>	<b>+\$20</b>	• <b>Grade 3 / Grade-in B</b>	<b>+\$40</b>
		• <b>Grade 4 / Grade-in C</b>	<b>+\$30</b>	• <b>Grade 4 / Grade-in C</b>	<b>+\$60</b>
		• <b>Grade 5 / Grade-in D</b>	<b>+\$40</b>	• <b>Grade 5 / Grade-in D</b>	<b>+\$80</b>
		• <b>Grade 6 / Grade-in E</b>	<b>+\$50</b>	• <b>Grade 6 / Grade-in E</b>	<b>+\$100</b>
		• <b>Weksy Quilt</b>	<b>+\$45</b>	• <b>LG1 Evita / C.O.L.</b>	<b>+\$67</b>
		• <b>LG1 Evita / C.O.L.</b>	<b>+\$22</b>	• <b>LG2 Lena - LDEL, LLUT, LORC only*</b>	<b>+\$75</b>
		• <b>LG2 Lena - LDEL, LLUT, LORC only*</b>	<b>+\$25</b>	• <b>LG3 Vulcano - LMIT, LSTG only*</b>	<b>+\$82</b>
		• <b>LG3 Vulcano - LMIT, LSTG only*</b>	<b>+\$27</b>		

Note: Fabric application testing is required for Grade-in and COM materials. Due to trilobe seat shape, patterns will not align. We recommend Solid and Solid Texture textiles.



Note: Fabric application testing is required for Grade-in and COM materials. Due to trilobe seat shape, patterns will not align. We recommend Solid and Solid Texture textiles.

\*For NON In-Stock colors, check with OM Seating for additional pricing details.

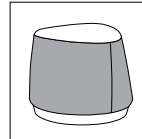
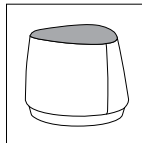
\*For NON In-Stock colors, check with OM Seating for additional pricing details.





### OTHER OPTIONS (append to above nomenclature to add to, or override existing options)

Casters		
Code		List
 <b>-55C</b> 55mm Carpet Caster		<b>\$28</b>
 <b>-50SS</b> 50mm Safety Soft caster, minimizes chair movement when <b>NOT</b> in use		<b>\$35</b>
 <b>-50R</b> 50mm Reverse Brak- ing caster, restricts chair movement when chair <b>IS</b> in use		<b>\$49</b>



## ORDER NOMENCLATURE



Example: **PLT-T** — **3104** — **3104** — **RND** — **J0030** — **GR01** — **55MS**

Model #    Seat Uph    Side Uph    Tablet Shape    Tablet Finish    Base Package    Casters/Glide

4. Tablet Shapes		
Code		List
	<b>-RND</b> Round 18" diameter	<b>-\$15</b>
	<b>-REC</b> Rectangle 22" x 14"	<b>+\$0</b>

Note: Tablet surface will not have a button for Fixed Height (-TF) version.

5. Tablet Finishes		
Code		List
	<b>-J0030</b> FENIX® Blanco Alaska with natural finish polished edge MDF*	<b>+\$0</b>
	<b>-J0724</b> FENIX® Grigio Bromo with natural finish polished edge MDF	<b>+\$0</b>
	<b>-BAMB</b> Solid Bamboo Wood	<b>+\$49</b>

6. Base Packages (includes height adjustable button, column and base)		
Code		List
	<b>-GR01</b> Palladium Grey	<b>+\$0</b>
	<b>-GR04</b> Graphite	<b>+\$0</b>

7. Casters / Glide	
Code	List
<b>55MS</b> 55mm Multi-Surface Casters	<b>+\$0</b>
<b>GLD</b> Glide Base	<b>+\$52</b>

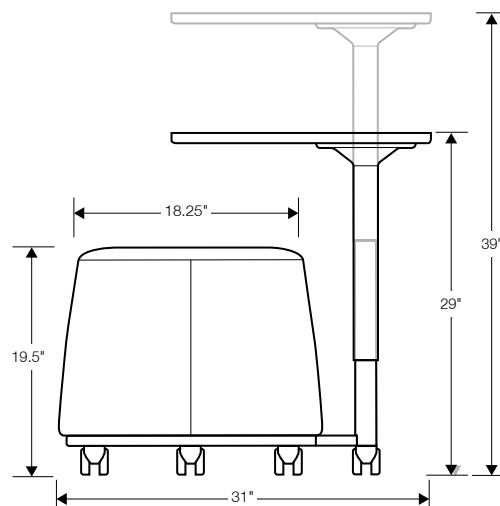

Dimensions	W	D	H
Overall	31"	22"	29" - 39"
Seat	18.25"	18.25"	N/A
Back	N/A	N/A	N/A

Upholstery	Back	Pouf
COM*	N/A	1.5 yd.
Shipping	Carton Wt.	FedEx Wt.
	67 lbs.	101 lbs.

\*For big pattern repeats, check with OM



# Plot Twist™ Pouf with Backrest (PLT-B)

Collaborative seating

## Plot Twist Core Features:

- Upholstered Swivel Seat
- 300 lb. Weight Capacity
- 12-year Limited Warranty

**Note:** Green font color indicates default build for "most popular" configuration of this spread.

1. Model		2. Back Upholstery Fabric Application Testing Required		2. Seat Top Upholstery Option Fabric Application Testing Required	
Code	List	Code	List	Code	List
<b>PLT-B</b> Plot Twist with Backrest	<b>\$1,040</b>	• <b>Grade 1 / C.O.M.</b>	<b>\$0</b>	• <b>Grade 1 / C.O.M.</b>	<b>\$0</b>
		• <b>Grade 2 / Grade-in A</b>	<b>+\$30</b>	• <b>Grade 2 / Grade-in A</b>	<b>+\$10</b>
		• <b>Grade 3 / Grade-in B</b>	<b>+\$50</b>	• <b>Grade 3 / Grade-in B</b>	<b>+\$20</b>
		• <b>Grade 4 / Grade-in C</b>	<b>+\$70</b>	• <b>Grade 4 / Grade-in C</b>	<b>+\$30</b>
		• <b>Grade 5 / Grade-in D</b>	<b>+\$90</b>	• <b>Grade 5 / Grade-in D</b>	<b>+\$40</b>
		• <b>Grade 6 / Grade-in E</b>	<b>+\$110</b>	• <b>Grade 6 / Grade-in E</b>	<b>+\$50</b>
		• <b>LG1 Evita / C.O.L.</b>	<b>+\$31</b>	• <b>Wersy Quilt</b>	<b>+\$45</b>
		• <b>LG2 Lena - LDEL, LLUT, LORC only**</b>	<b>+\$41</b>	• <b>LG1 Evita / C.O.L.</b>	<b>+\$22</b>
		• <b>LG3 Vulcano - LMIT, LSTG only**</b>	<b>+\$51</b>	• <b>LG2 Lena - LDEL, LLUT, LORC only*</b>	<b>+\$25</b>
				• <b>LG3 Vulcano - LMIT, LSTG only*</b>	<b>+\$27</b>

\* Grade 5 knit patterns will not have a back center vertical line stitch detail.

\*\* For NON In-Stock colors, check with OM Seating for additional pricing details.

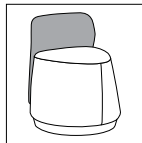

Note: Fabric application testing is required for Grade-in and COM materials. Due to trilobe seat shape, patterns will not align. We recommend Solid and Solid Texture textiles.

\*For NON In-Stock colors, check with OM Seating for additional pricing details.

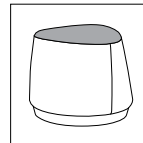

## OTHER OPTIONS (append to above nomenclature to add to, or override existing options)

Casters		
Code		List
 <b>-55C</b> 55mm Carpet Caster		<b>\$24</b>
 <b>-50SS</b> 50mm Safety Soft caster, minimizes chair movement when <b>NOT</b> in use		<b>\$30</b>
 <b>-50R</b> 50mm Reverse Brak- ing caster, restricts chair movement when chair <b>IS</b> in use		<b>\$42</b>

## ORDER NOMENCLATURE

Example: **PLT-B** — **3104** — **3104** — **3104** — **GR01** — **55MS**

Model #    Back Uph    Seat Uph    Side Uph    Base Finish    Casters/ Glide

3. Side Panel Upholstery Option Fabric Application Testing Required	
Code	List
• <b>Grade 1 / C.O.M.</b>	<b>\$0</b>
• <b>Grade 2 / Grade-in A</b>	<b>+\$20</b>
• <b>Grade 3 / Grade-in B</b>	<b>+\$40</b>
• <b>Grade 4 / Grade-in C</b>	<b>+\$60</b>
• <b>Grade 5 / Grade-in D</b>	<b>+\$80</b>
• <b>Grade 6 / Grade-in E</b>	<b>+\$100</b>
• <b>LG1 Evita / C.O.L.</b>	<b>+\$67</b>
• <b>LG2 Lena - LDEL, LLUT, LORC only*</b>	<b>+\$75</b>
• <b>LG3 Vulcano - LMIT, LSTG only*</b>	<b>+\$82</b>

Note: Fabric application testing is required for Grade-in and COM materials. Due to trilobe seat shape, patterns will not align. We recommend Solid and Solid Texture textiles.

\*For NON In-Stock colors, check with OM Seating for additional pricing details.

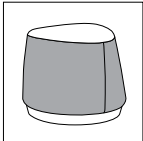

5. Base Finishes	
Code	List
<b>-GR01</b> Palladium Grey	<b>+\$0</b>
<b>-GR04</b> Graphite	<b>+\$0</b>

6. Casters / Glide	
Code	List
<b>55MS</b> 55mm Multi-Surface Casters	<b>\$0</b>
<b>GLD</b> Glide Base	<b>+\$52</b>

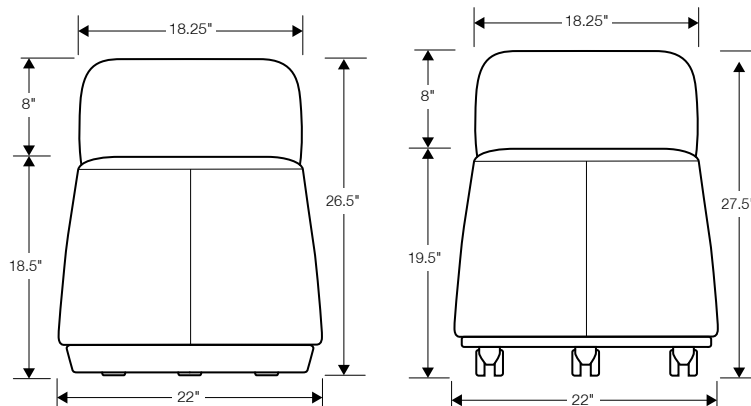

Dimensions	W	D	H
Overall (w/ glide base)	22"	24"	26.5"
Overall (w/ casters)	22"	24"	27.5"
Seat	18.25"	18.25"	18.5"
Back	N/A	N/A	8"

Upholstery	Back	Pouf
COM*	1.0 yd.	1.5 yd.
Shipping	Carton Wt.	FedEx Wt.
	53 lbs.	101 lbs.

\*For big pattern repeats, check with OM



# Plot Twist™ with Backrest & Tablet (PLT-BT)

Collaborative seating

### Plot Twist Core Features:

- Upholstered Swivel Seat
- User in Seat: Weight Rating = 300 lbs. max
- Objects on Tablet: Weight Rating = 100 lbs. max
- 12-year Limited Warranty

**Note:** Green font color indicates default build for "most popular" configuration of this spread.

1. Model		2. Back Upholstery		3. Seat Top Upholstery Option Fabric Application Testing Required		4. Side Panel Upholstery Option Fabric Application Testing Required	
Code	List	Code	List	Code	List	Code	List
<b>PLT-BT</b> Plot Twist with Backrest and Adjustable Height Tablet	<b>\$1,828</b>	• <b>Grade 1 / C.O.M.</b>	<b>\$0</b>	• <b>Grade 1 / C.O.M.</b>	<b>\$0</b>	• <b>Grade 1 / C.O.M.</b>	<b>\$0</b>
<b>PLT-BTF</b> Plot Twist with Backrest and Fixed Height Tablet	<b>\$1,700</b>	• <b>Grade 2 / Grade-in A</b>	<b>+\$30</b>	• <b>Grade 2 / Grade-in A</b>	<b>+\$10</b>	• <b>Grade 2 / Grade-in A</b>	<b>+\$20</b>
		• <b>Grade 3 / Grade-in B</b>	<b>+\$50</b>	• <b>Grade 3 / Grade-in B</b>	<b>+\$20</b>	• <b>Grade 3 / Grade-in B</b>	<b>+\$40</b>
		• <b>Grade 4 / Grade-in C</b>	<b>+\$70</b>	• <b>Grade 4 / Grade-in C</b>	<b>+\$30</b>	• <b>Grade 4 / Grade-in C</b>	<b>+\$60</b>
		• <b>Grade 5* / Grade-in D</b>	<b>+\$90</b>	• <b>Grade 5* / Grade-in D</b>	<b>+\$40</b>	• <b>Grade 5* / Grade-in D</b>	<b>+\$80</b>
		• <b>Grade 6 / Grade-in E</b>	<b>+\$110</b>	• <b>Grade 6 / Grade-in E</b>	<b>+\$50</b>	• <b>Grade 6 / Grade-in E</b>	<b>+\$100</b>
		• <b>LG1 Evita / C.O.L.</b>	<b>+\$31</b>	• <b>Werksy Quilt</b>	<b>+\$45</b>	• <b>LG1 Evita / C.O.L.</b>	<b>+\$67</b>
		• <b>LG2 Lena</b> - LDEL, LLUT, LORC only**	<b>+\$41</b>	• <b>LG1 Evita / C.O.L.</b>	<b>+\$22</b>	• <b>LG2 Lena</b> - LDEL, LLUT, LORC only*	<b>+\$75</b>
• <b>LG3 Vulcano</b> - LMIT, LSTG only**	<b>+\$51</b>	• <b>LG2 Lena</b> - LDEL, LLUT, LORC only*	<b>+\$25</b>	• <b>LG3 Vulcano</b> - LMIT, LSTG only*	<b>+\$82</b>		
		• <b>LG3 Vulcano</b> - LMIT, LSTG only*	<b>+\$27</b>				

\* Grade 5 knit patterns will not have a back center vertical line stitch detail.

\*\* For NON In-Stock colors, check with OM Seating for additional pricing details.

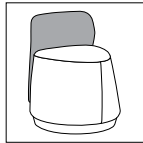

Note: Fabric application testing is required for Grade-in and COM materials. Due to trilobe seat shape, patterns will not align. We recommend Solid and Solid Texture textiles.

\*For NON In-Stock colors, check with OM Seating for additional pricing details.

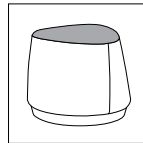

Note: Fabric application testing is required for Grade-in and COM materials. Due to trilobe seat shape, patterns will not align. We recommend Solid and Solid Texture textiles.

\*For NON In-Stock colors, check with OM Seating for additional pricing details.

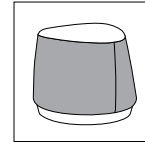

### OTHER OPTIONS (append to above nomenclature to add to, or override existing options)



Casters		
Code		List
 <b>-55C</b> 55mm Carpet Caster		<b>\$28</b>
 <b>-50SS</b> 50mm Safety Soft caster, minimizes chair movement when <b>NOT</b> in use		<b>\$35</b>
 <b>-50R</b> 50mm Reverse Braking caster, restricts chair movement when chair <b>IS</b> in use		<b>\$49</b>





## ORDER NOMENCLATURE



Example: **PLT-BT** — **3104** — **3104** — **3104** — **REC** — **J0030** — **GR01** — **55MS**



Model #    Back Uph    Seat Uph    Side Uph    Tablet Shape    Tablet Finish    Base Package    Casters/ Glide

5. Tablet Shapes		
Code		List
	<b>-RND</b> Round 18" diameter	<b>-\$15</b>
	<b>-REC</b> Rectangle 22" x 14"	<b>+\$0</b>

Note: Tablet surface will not have a button for Fixed Height (-BTF) version.

6. Tablet Finishes		
Code		List
	<b>-J0030</b> FENIX® Blanco Alaska with natural finish polished edge MDF	<b>+\$0</b>
	<b>-J0724</b> FENIX® Grigio Bromo with natural finish polished edge MDF	<b>+\$0</b>
	<b>-BAMB</b> Solid Bamboo Wood	<b>+\$49</b>

7. Base Packages (includes height adjustable button, column and base)		
Code		List
	<b>-GR01</b> Palladium Grey	<b>+\$0</b>
	<b>-GR04</b> Graphite	<b>+\$0</b>

8. Casters / Glide		
Code		List
	<b>55MS</b> 55mm Multi-Surface Casters	<b>+\$0</b>
	<b>GLD</b> Glide Base	<b>+\$52</b>

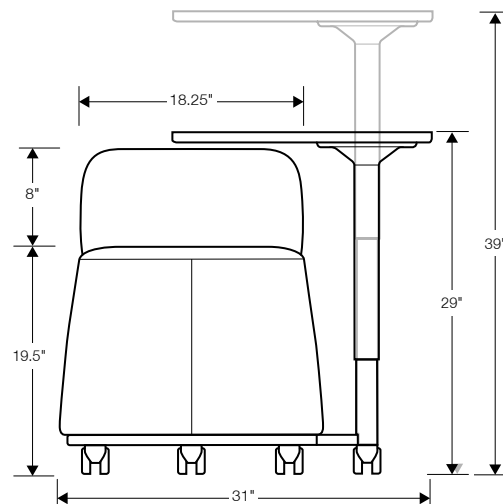

Dimensions	W	D	H
Overall	31"	24"	29" - 39"
Seat	18.25"	18.25"	N/A
Back	18.25"	N/A	8"

Upholstery	Back	Pouf
COM*	1.0	1.5 yd.
Shipping	Carton Wt.	FedEx Wt.
	74 lbs.	101 lbs.

\*For big pattern repeats, check with OM



# SG

**Features:**

- Begins @ \$213 armless (SG300) / \$239 with arms (SG3A)
- Contemporary design stackable guest seating ideal for any occasional use environment
- Tapered legs with self-leveling glides (SG3\_)



# SG

Stackable | Guest Seating

perforated plastic back

## New Backrest

Model	Description	Textile Grade-In	List	Specifications
SG1K	Cushion seat	Grade 1 / C.O.M.	\$239.00	Overall width 25"
	Perforated black plastic back	Grade 2 / Grade-in A	\$254.00	Overall height 33.75" (fixed)
	Armless	Grade 3 / Grade-in B	\$269.00	Back 20" w x 15.25" h
	Carpet casters on all 4 legs (default)	Grade 4 / Grade-in C	\$284.00	Seat 19" w x 20" d
		Grade 5 / Grade-in D	\$299.00	Seat height 18" (fixed)
		Grade 6 / Grade-in E	\$314.00	COM .80 yd./per 2 chairs
	Stack up to 4 without dolly <b>(No dolly available for SG1K)</b> <b>Ships 2 in a box**</b> (back detached)			Carton weight 19 pounds FedEx weight 104 pounds Arms (armless) Warranty 7 year limited



*Ships with back detached when more than 1, up to 3 per carton, but may vary. Call OM for details.*

## New Backrest

Model	Description	Textile Grade-In	List	Specifications
SG2K	Cushion seat	Grade 1 / C.O.M.	\$265.00	Overall width 25"
	Perforated black plastic back	Grade 2 / Grade-in A	\$280.00	Overall height 33.75" (fixed)
	Neo-classic arm design	Grade 3 / Grade-in B	\$295.00	Back 20" w x 15.25" h
	Rear casters/front glides	Grade 4 / Grade-in C	\$310.00	Seat 19" w x 20" d
		Grade 5 / Grade-in D	\$325.00	Seat height 18" (fixed)
		Grade 6 / Grade-in E	\$340.00	COM .80 yd./per 2 chairs
	Stack up to 4 without dolly <b>(No dolly available for SG2K)</b> <b>Ships 2 in a box**</b> (back detached)			Carton weight 20 pounds FedEx weight 104 pounds Arms Included Warranty 7 year limited



*Ships with back detached when more than 1, up to 3 per carton, but may vary. Call OM for details.*

**SPLIT CARTON FEE \$20 NET (i.e., 3 chairs shipping in 3 cartons).**

\*SG2K and SG1K, no ganging device available.

\*\*OM Seating reserves the right to change quantity shipped per a carton

Upholstery option for meeting CA-Technical Bulletin-133 NOT available on ST/SG Series stacking chairs. ; FedEx weight is calculated using FedEx dimensional standards to determine billable weight. ; Pricing and specifications subject to change without notification.

contoured plastic back

Model	Description	Textile Grade-In	List	Specifications
SG300	Graphite-color seat/back	Black polypropylene	\$213.00	Overall width 21"
	Silver-color tapered legs			Overall height 32" (fixed)
	Wall-saving design			Back 19" w x 16" h
	Contoured molded seat			Seat 18" w x 19" d
	Self-leveling glides			Seat height 17" (fixed)
				COM N/A
	Stack up to 5 without dolly			Carton weight 16 pounds
	<b>Ships 2 in a box</b>			FedEx weight 104 pounds
				Arms N/A
				Warranty 7 year limited

Model	Description	Textile Grade-In	List	Specifications
SG3A	Graphite-color seat/back	Black polypropylene	\$239.00	Overall width 23"
	Silver-color tapered legs			Overall height 32" (fixed)
	Wall-saving design			Back 19" w x 16" h
	Contoured molded seat			Seat 18" w x 19" d
	Outboard arm design			Seat height 17" (fixed)
	Self-leveling glides			COM N/A
	Stack up to 5 without dolly			Carton weight 19 pounds
	<b>Ships 2 in a box</b>			FedEx weight 104 pounds
				Arms Included
				Warranty 7 year limited

Model	Description	Textile Grade-In	List	Specifications
SG3B	Graphite-color seat/back	Grade 1 / C.O.M.	\$291.00	Overall width 23"
	Silver-color tapered legs	Grade 2 / Grade-in A	\$306.00	Overall height 32" (fixed)
	Wall-saving design	Grade 3 / Grade-in B	\$321.00	Back 19" w x 16" h
	Contoured molded seat	Grade 4 / Grade-in C	\$336.00	Seat 18" w x 19" d
	Cushion seat/back	Grade 5 / Grade-in D	\$351.00	Seat height 18" (fixed)
	Outboard arm design	Grade 6 / Grade-in E	\$366.00	COM .75 yd.
	Self-leveling glides			Carton weight 22 pounds
	Stack up to 4 without dolly			FedEx weight 104 pounds
	<b>Ships 2 in a box</b>			Arms Included
				Warranty 7 year limited

Model	Description	Textile Grade-In	List	Specifications
SG3C	Graphite-color seat/back	Grade 1 / C.O.M.	\$265.00	Overall width 21"
	Silver-color tapered legs	Grade 2 / Grade-in A	\$280.00	Overall height 32" (fixed)
	Wall-saving design	Grade 3 / Grade-in B	\$295.00	Back 19" w x 16" h
	Contoured molded seat	Grade 4 / Grade-in C	\$310.00	Seat 18" w x 19" d
	Cushion seat/back	Grade 5 / Grade-in D	\$325.00	Seat height 18" (fixed)
	Self-leveling glides	Grade 6 / Grade-in E	\$340.00	COM .75 yd.
	Stack up to 4 without dolly			Carton weight 21 pounds
	<b>Ships 2 in a box</b>			FedEx weight 104 pounds
				Arms N/A
				Warranty 7 year limited

**SPLIT CARTON FEE \$20 NET (i.e., 2 chairs shipping in 2 cartons).**

Upholstery option for meeting CA-Technical Bulletin-133 NOT available on ST/SG Series stacking chairs. ; FedEx weight is calculated using FedEx dimensional standards to determine billable weight. ; Pricing and specifications subject to change without notification.

# SG

Stackable | Guest Seating

contoured plastic back

## Model

# SG3W



## Description

Graphite-color back  
 Graphite-color arms  
 Silver-color tapered legs  
 Wall-saving design  
 Molded seat cushion  
 Molded back cushion  
 Self-leveling glides

Stack up to 3 without dolly

**Ships 2 in a box**

## Textile Grade-In

Grade 1 / C.O.M.	\$320.00
Grade 2 / Grade-in A	\$335.00
Grade 3 / Grade-in B	\$350.00
Grade 4 / Grade-in C	\$365.00
Grade 5 / Grade-in D	\$380.00
Grade 6 / Grade-in E	\$395.00

## List

## Specifications

Overall width	23"
Overall height	32" (fixed)
Back	19" w x 16" h
Seat	18" w x 19" d
Seat height	18" (fixed)
COM	1 yd.
Carton weight	23 pounds
FedEx weight	104 pounds
Arms	Included
Warranty	7 year limited

mesh back

## Model

# SG5K



## Description

Graphite-color seat/back  
 Silver-color tapered legs  
 Wall-saving design  
 Contoured molded seat  
 Outboard arm design  
 Carpet casters on all 4 legs (default)

Stack up to 4 without dolly

**(No dolly available for SG5K)**

**Ships 2 in a box** (back detached)

## Textile Grade-In

Grade 1 / C.O.M.	\$395.00
Grade 2 / Grade-in A	\$410.00
Grade 3 / Grade-in B	\$425.00
Grade 4 / Grade-in C	\$440.00
Grade 5 / Grade-in D	\$455.00
Grade 6 / Grade-in E	\$470.00

## List

## Specifications

Overall width	25.5"
Overall height	36.5" (fixed)
Back	21" w x 19" h
Seat	18" w x 18" d
Seat height	18" (fixed)
COM	0.80 yd./per 2 chairs
Carton weight	20 pounds
FedEx weight	28 pounds
Arms	Included
Warranty	7 year limited

common options

## Suggested Options

### Dolly

**STDLY3N** - list: 198.00

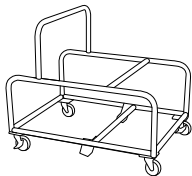

## Description

Storage Dolly

Lockable casters  
 Steel frame  
 Stacks up to 10 upholstered SG3x chairs  
 Stacks up to 12 non-upholstered SG3 Series chairs (e.g. SG300 & SG3A but **excluding SG1K, SG2K, & SG5K**)

*Also sold at discount in near new condition*

## Specifications

Overall length	31"
Overall width	22.5"
Overall height	27"
FedEx weight	20 pounds*
Warranty	5 year limited

### Ganging

**GANGING-SG**

list: 12.00 (per set of 2)



## Description

Ganging Device

Sold in pairs  
 One pair required to gang two chairs  
 Feature for SG3x Chairs only

## Specifications

Overall length	6.25"
Overall width	1.5"
Overall height	1"

**SPLIT CARTON FEE \$20 NET (i.e., 2 chairs shipping in 2 cartons).**

\*Consult with an OM representative for weights and questions related to shipping storage dollies.

Upholstery option for meeting CA-Technical Bulletin-133 NOT available on ST/SG Series stacking chairs. ; FedEx weight is calculated using FedEx dimensional standards to determine billable weight. ; Pricing and specifications subject to change without notification.

# ST

## Features:

- Begins @ \$166 armless / \$220 with SRS40 arms (ST400)
- Sled-base higher density stacking chairs for any occasional use environment
- Simple, budget-oriented design and appeal
- Easy to set up and store away



# Stacking Chair Series (ST)

Stackable | Guest Seating

contoured plastic back

Model	Description	Textile Grade-In	List	Specifications
ST400	Black plastic seat	Black Plastic	\$166.00	Overall width 21"
	Black plastic back			Overall height 32" (fixed)
	Silver powder coat frame			Back 19" w x 16" h
	Stack up to 5 without dolly	<i>Order in multiples of 3 chairs, otherwise additional carton charge will be applied.</i>  <i>Ships up to 3 per carton, but may vary. Call OM for details.</i>		Seat 18" w x 18" d
	Stack up to 30 with dolly			Seat height 17.5" (fixed)
	74.5" tall			COM N/A
	48" deep			Carton weight 10 pounds
	25" wide			FedEx weight 104 pounds/per carton
	<b>Ships 2 in a box**</b>			Arms SR-40 (see page 135)
				Warranty 7 year limited

Model	Description	Textile Grade-In	List	Specifications
ST400F	Upholstered seat	Grade 1 / C.O.M.	\$271.00	Overall width 21"
	Upholstered back	Grade 2 / Grade-in A	\$286.00	Overall height 32" (fixed)
	Silver powder coat frame	Grade 3 / Grade-in B	\$301.00	Back 19" w x 16" h
	Stack up to 4 without dolly	Grade 4 / Grade-in C	\$316.00	Seat 18" w x 18" d
	Stack up to 15 with dolly	Grade 5 / Grade-in D	\$331.00	Seat height 18" (fixed)
	<b>Ships 2 in a box**</b>	Grade 6 / Grade-in E	\$346.00	COM .75 yd./per 2 chairs
		<i>Order in multiples of 2 chairs, otherwise additional carton charge will be applied.</i>  <i>Ships up to 2 per carton, but may vary. Call OM for details.</i>		Carton weight 11 pounds
				FedEx weight 104 pounds/per carton
				Arms SR-40 (see page 135)
				Warranty 7 year limited

\*\*OM Seating reserves the right to change quantity shipped per a carton

**SPLIT CARTON FEE \$20 NET (i.e., 3 chairs shipping in 3 cartons).**

**NOTE** When ordering an ST400 with the upholstery option, select a fabric color first and then use that fabric's color number to fill in the space after "ST-\_\_\_" (example: ST-1004 is an ST400 chair upholstered with Basic no. 1004 Navy).

**DESIGN STATEMENT** Very easy to set up and so convenient to store away. A wide range of stacking chair lines makes OM a one-stop provider for all your seating needs.

• Upholstery option for meeting CA-Technical Bulletin-133 NOT available on ST400's Series stacking chair.  
 FedEx weight is calculated using FedEx dimensional standards to determine billable weight. ; Pricing and specifications subject to change without notification.





# Stacking Chair Series (ST)

Stackable | Guest Seating

common options

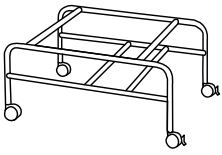
## Suggested Options

Dolly	STDLY4N - list: \$110.00	Description	Storage Dolly	Specifications
		Lockable casters Steel frame Stacks up to 15 ST400F chairs Stacks up to 30 ST400 chairs		Overall length 34" Overall width 23.5" Overall height 15" FedEx weight 15 pounds* Warranty 5 year limited
<i>Also sold at discount in near new condition</i>				
Arm	SR40 - list: \$54.00 (a pair)	Description	Arms	Specifications
		Sold in pairs (black arm pad, silver frame) Each pair contains one left arm and one right arm Feature for ST400 Series chairs only Adds approximately 1.75" to each side on overall width for ST400 Series		Overall length 11"
Ganging	GANGING-ST4 list: \$10.00 per set (2)	Description	Ganging Device	Specifications
		Sold in pairs One pair required to gang two chairs Feature for ST400 and ST400F Series chairs only Works universally for ganging ST400 Series chairs with or without arms		Overall length 6.3" Overall width 1.2" Overall height 0.8"

\*Consult with an OM representative for weights and questions related to shipping storage dollies.

• Upholstery option for meeting CA-Technical Bulletin-133 NOT available on ST400's Series stacking chair.  
 FedEx weight is calculated using FedEx dimensional standards to determine billable weight. ; Pricing and specifications subject to change without notification.



# Tibidi®

## Features:

- Begins @\$275 armless / \$345 with arms
- High density stacker, stacks 45 high on a dolly, stacks 25 for upholstered versions
- Slim and minimalist design for multipurpose environments, cafés and private offices
- TD2 - color-matched polycolor on seat, back and arm caps
- TD2-S and TD2-F - seat and full upholstery available for added comfort

















# Tibidi (TD2-)

Stacking | Guest | Multi-use

- Tibidi Core Features:**
- HD Stacker
  - Stacks 45 High on Dolly
  - 275 lb. Weight Capacity
  - 7 Year Limited Warranty



**Note:** Green font color indicates default build for "most popular" configuration of this spread.

1. Model		2. Arms		3. Polycolor (Arms, Back and Seat match)		4. Frame Finish	
Code	List	Code	List	Code	List	Code	List
<b>TD2</b>	<b>\$275</b>	 <b>-N</b> (No arms)	<b>+\$0</b>	 <b>-BK01</b> Modern Black	<b>+\$0</b>	 <b>-CHM*</b> Chrome	<b>\$0</b>
		 <b>-A</b> (With arms)	<b>+\$70</b>	 <b>-GN04</b> Moss	<b>+\$0</b>	 <b>-BLK</b> Black	<b>+\$0</b>
				 <b>-BR01</b> Sand	<b>+\$0</b>	 <b>-WHT</b> White	<b>+\$0</b>
				 <b>-WT03</b> Snow White	<b>+\$0</b>	*Most durable option for frequent stacking / unstacking.	
				 <b>-BL04</b> Glacier	<b>+\$0</b>		
				 <b>-GR05</b> Fog	<b>+\$0</b>		
				 <b>-BL02</b> Navy	<b>+\$0</b>		
				 <b>-RD03</b> Brick	<b>+\$0</b>		

**Note:** Ganging Glides available and standard on armless version only.

**Note:** Bottom cover matches seat polycolor.

**OTHER OPTIONS** (append to above nomenclature to add to, or override existing options)

Polycolor	List	Glides	List	Dolly	List
<b>-A-polycolor #</b> Arm polycolor	<b>+\$5</b>	<b>-NGLD</b> Glideless option	<b>-\$5</b>	<b>-TD2DLY</b> Dolly	<b>+\$306</b>
<b>-B-polycolor #</b> Back polycolor	<b>+\$5</b>				
<b>-S-polycolor #</b> Seat polycolor	<b>+\$5</b>				

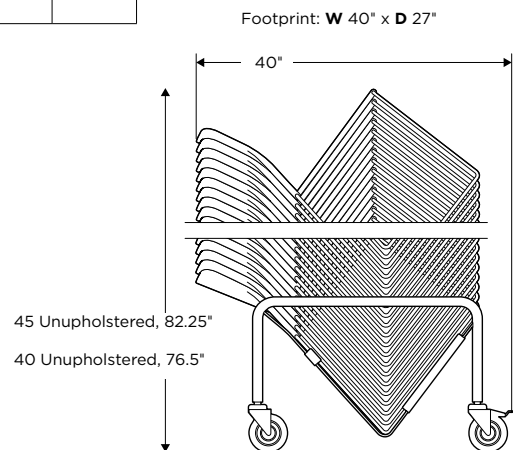





# Tibidi w/ Upholstered Seat (TD2-S)

Stacking | Guest | Multi-use



### Tibidi Core Features:

- HD Stacker with Upholstered Seat
- Stacks 25 High on Dolly
- 275 lb. Weight Capacity
- 7 Year Limited Warranty



**Note:** Green font color indicates default build for "most popular" configuration of this spread.

1. Model	
Code	List
TD2-S	\$275

2. Arms		
Code		List
 -N (No arms)		+\$0
 -A (With arms)		\$70

**Note:** Ganging Glides available and standard on armless version only.

3. Polycolor (Arms, Back and Seat match)		
Code		List
 -BK01 Modern Black		+\$0
 -GN04 Moss		+\$0
 -BR01 Sand		+\$0
 -WT03 Snow White		+\$0
 -BL04 Glacier		+\$0
 -GR05 Fog		+\$0
 -BL02 Navy		+\$0
 -RD03 Brick		+\$0

**Note:** Bottom cover matches seat polycolor.

4. Upholstery	
Currently Approved OM In-Stock Fabrics	
Code	List
• Grade 2 / SoftSit	+\$30
• Grade 3 / Wanderlust	+\$35
• Grade 3 / Cinema	+\$35
• Grade 3 / Illusion	+\$35

Fabric Application Testing is required for non-approved materials. Check with OM Seating for approved materials. [Click here](#) for Fabric Application Testing policy.

### OTHER OPTIONS (append to above nomenclature to add to, or override existing options)

Polycolor	List
-A-polycolor # Arm polycolor	+\$5
-B-polycolor # Back polycolor	+\$5

Glides	List
-NGLD Glideless option	-\$5

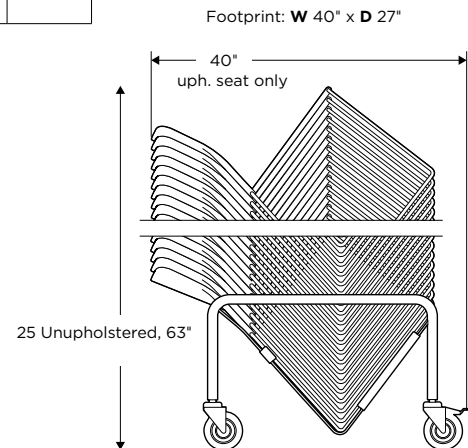

Dolly	List
-TD2DLY Dolly	+\$306



## MODEL CODE

Example: TD2-S -- N - BK01 - 3104 - CHM (new format)

Model #    Arm    Poly color    Seat uph.    Frame

4. Frame Finish		
	Code	List
	<b>-CHM*</b> Chrome	<b>\$0</b>
	<b>-BLK</b> Black	<b>+\$0</b>
	<b>-WHT</b> White	<b>+\$0</b>

\*Most durable option for frequent stacking / unstacking.

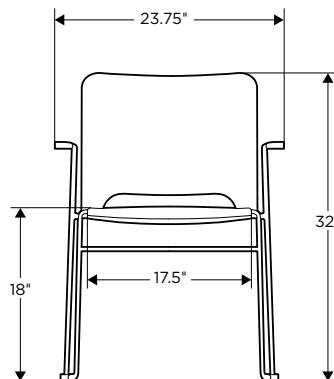
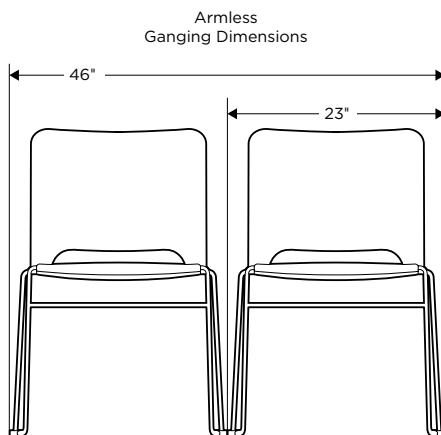

Dimensions	W	D	H
Overall	23.75"	23.75"	32"
Seat	17.5"	16.75"	18"
Back	17.5"	N/A	14"

Upholstery	Back	Seat	Backshell
COM	N/A	N/A	N/A
Shipping	Carton Wt.	FedEx Wt.	
	14 lbs.	121 lbs.	



# Tibidi Fully Upholstered (TD2-F)

Stacking | Guest | Multi-use

### Tibidi Core Features:

- HD Stacker Fully Upholstered
- Stacks 25 High on Dolly
- 275 lb. Weight Capacity
- 7 Year Limited Warranty



**Note:** Green font color indicates default build for "most popular" configuration of this spread.

1. Model	
Code	List
TD2-F	\$275

2. Arms		
Code		List
 -N No arm		+\$0
 -A (With arms)		
Choose a Polycolor for the arms		
 A-BK01 Modern Black		+\$70
 A-GN04 Moss		+\$0
 A-BR01 Sand		+\$70
 A-WT03 Snow White		+\$70
 A-BL04 Glacier		+\$70
 A-GR05 Fog		+\$70
 A-BL02 Navy		+\$70
 A-RD03 Brick		+\$70



**Note:** Ganging Glides available and standard on armless version only.

3. Upholstery	
Currently Approved OM In-Stock Fabrics	
Code	List
• Grade 2 / SoftSit	+\$55
• Grade 3 / Wanderlust	+\$65
• Grade 3 / Cinema	+\$65
• Grade 3 / Illusion	+\$65

Fabric Application Testing is required for non-approved materials. Check with OM Seating for approved materials. [Click here](#) for Fabric Application Testing policy.

**Note:**

- Bottom cover polycolor:
- Black on CHM and BLK frames
  - White on WHT frames

4. Frame Finish		
	Code	List
 -CHM* Chrome		\$0
 -BLK Black		+\$0
 -WHT White		+\$0

\*Most durable option for frequent stacking / unstacking.

### OTHER OPTIONS (append to above nomenclature to add to, or override existing options)

Glides	List
-NGLD Glideless option	-\$5

Mix and Match Seat and Back Upholstery	List
-S Fabric Code Seat upholstery	+\$10
-B Fabric Code Back upholstery	+\$10

Dolly	List
-TD2DLY Dolly	+\$306

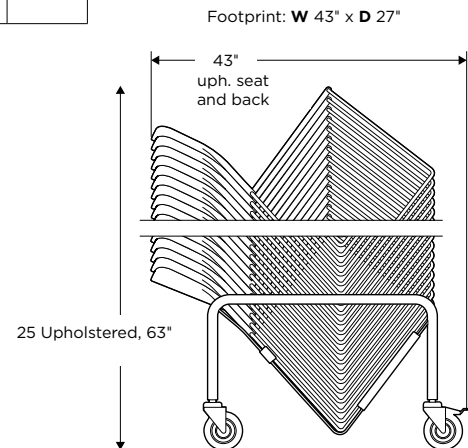







## Features:

- Begins @ \$837 armless (TY608) / \$956 with KR200 arms (TY608-KR200- . . .)
- Truly. a unique design to fit any work, conference or executive environment
- Patented, award-winning design offers a range of aesthetic and functional choices
- Multiple ergonomic mechanisms, 3 seat sizes, and 6 different polyback colors to make Truly. yours
- Designed by Francisco Romero of Phidesign





Truly.®

Task | Conference | Executive | Stools



about Truly.®

## TruFit™ Back System

- 1. Back height adjustment.**  
Click it all the way up, Then, all the way down to reset. Position the height where you want.
- 2. Adjustable lumbar.**  
Loosen to the left. Tighten to the right. Adjust the back arch as you like.
- 3. Lively "working support".** Truly's back is a next generation polymer blend that allows the back to flex as you move, work, & create!



Integrated ratchet tuned for a smooth vertical adjustment and sophisticated clicking timbre

Truly.® Jacket & Wrap

## Jacket & Wrap

Back Upholstery Compatibility Guide\*

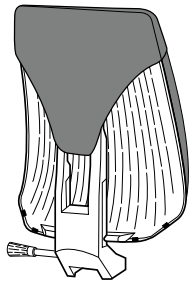

### JACKET | Pre-approved in-stock options

Great choice for environments that could use the added visual flexibility and warmth afforded by our user-removable / replaceable Truly. "jacket".

Grade 1: Basic, Celestial, Spice	\$ 86.00
Grade 2: Arcade, Clue, Drift, Soft Sit, Track	\$126.00
Grade 3: Cinema, Dart, Free, Illusion, Stage xox, Beau, Bliss, Wanderlust	\$166.00
Grade 4: Cover Cloth, Rocket, Hopsack	\$186.00
Grade 5: Architect, Myth	\$206.00
LG1: (none)	N/A
LG2: Lena	\$239.00
LG3: Vulcano	\$249.00

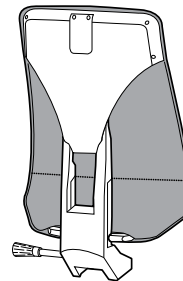

### WRAP | Pre-approved in-stock options

Great choice for performance / healthcare environments

Grade 1: (none)	N/A
Grade 2: Drift, Soft Sit	\$ 69.00
Grade 3: Cinema, Illusion, Stage, Beau, Bliss, Wanderlust	\$119.00
Grade 4: Zodiac Mesh, Hopsack	\$129.00
Grade 5: Architect, Myth, Solids	\$139.00
LG1: (none)	N/A
LG2: Lena	\$229.00
LG3: Vulcano	\$239.00

Please enter Fabric choice on the Truly. Order Worksheet, Item #6 on page 149 or 151 (stools).

#### \*Notes & Special Considerations:

- Truly. is uniquely designed with a backrest that bends & flexes considerably. Great for your back and lumbar support. Not as great for upholstery with stiffer or relatively thicker construction.
- Besides OM's pre-approved Truly. Jacket & Wrap options (as noted above) other material may be eligible. Application testing required with a fee. Check with OM for details.
- For Truly. back upholstery Jackets & Wraps – especially with OM in-stock leathers – natural folds, wrinkles, and gather will occur depending on the material chosen. OM will not warrant natural signs of use/wear.

# Truly® Mechanisms

SYNCHRONIZED MOTION

## Executive Synchro (MODEL TY628)

- A. Seat Height
- B. Seat Slider
- C. 5 position Tilt Lock\*
- D. Tilt Tension (telescopes out / in)
- E. Independent Back Angle

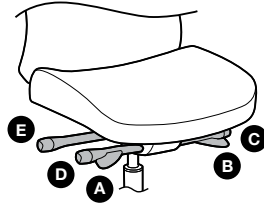

## Management Synchro (MODEL TY618)

- A. Seat Height
- B. Seat Slider
- C. 3 position Tilt Lock\*
- D. Tilt Tension

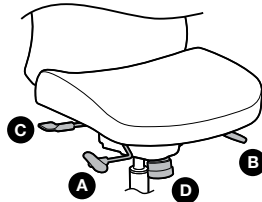

### \*Positive Back Release

After unlocking the (C.)Tilt Lock lever, lean into the backrest to release the tilt lock & resume normal tilt recline motion.

## Simple Synchro (MODEL TY608)

- A. Seat Height
- B. Seat Slider
- C. 1 position Tilt Lock (push in to engage)
- D. Tilt Tension

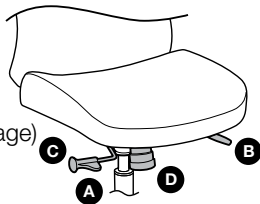

## Quick-Adjust Synchro (Advanced) (MODEL TY64b8)

- A. Seat Height
- B. Seat Slider
- C. 5-Tilt Range Limiter Positions
- D. 7-Tilt Tension Quick Adjust Settings
- E. Independent Back Angle
- F. Forward Seat Angle (for perching & back relief)

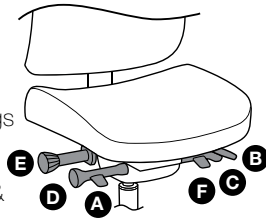

## Quick-Adjust Synchro (Simple) (MODEL TY64a8)

- A. Seat Height
- B. Seat Slider
- C. 5-Tilt Range Limiter Positions
- D. 7-Tilt Tension Quick Adjust Settings

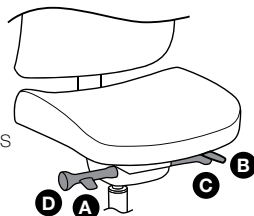

SELF-WEIGHING MOTION

## Body-Activated Motion (MODEL TY668)

- A. Seat Height
- B. Seat Slider
- C. 3 position Tilt Lock\*

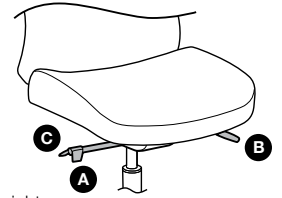

### Note

This model operates based on user body weight. (No Tilt Tension Adjustment)

### \*Positive Back Release

After unlocking the (C.)Tilt Lock lever, lean into the backrest to release the tilt lock & resume normal tilt recline motion.

BEST

INDEPENDENT MOTION

## Full Multi-Function (MODEL TY688)

- A. Seat Height
- B. Seat Slider
- C. Seat/Back Tilt and Lock
- D. Independent Back Angle
- E. Tilt Tension
- F. Forward Seat Angle (for perching & back relief)

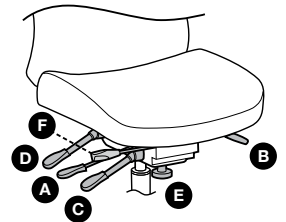

## Simple Multi-Function (MODEL TY678, TY673 & TY675)

- A. Seat Height
- B. Seat Slider
- C. Seat/BackTilt and Lock
- D. Independent Back Angle

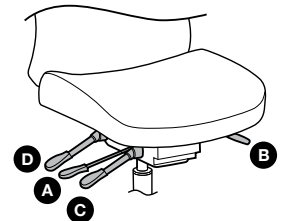

GOOD

## Guest Swivel (MODEL TY60gs8)

- A. Seat Height

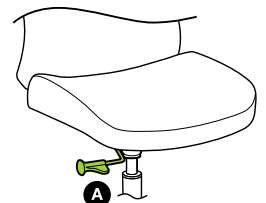



# Truly.® (TY6-)

Task | Conference | Executive

- Truly. Core Features:**
- TruFit™ System (self-conforming back)
  - EZ-back height adjustment
  - Lumbar depth adjustment
  - 300 lb. Weight Capacity
  - Lifetime Limited Warranty



Note: Green font color indicates default build for "most popular" configuration of this spread.

1. Model & Mechanism		2. Seat Size		3. Arms		4. Polyback Color		5. Truly.* Nameplate Color		
Code	List	Code	List	Code	List	Code	List		List	
<b>TY608</b> <b>Simple Synchro (-0)</b> • 1 Position tilt lock • Tilt tension	<b>+\$837</b>	<b>-TYP</b> • Seat: 18"w	<b>+\$0</b>		<b>-N</b> (No arms) <b>+\$0</b>		<b>-BK02*</b> Nitro Black (formerly -TB Modern Black)	<b>+\$0</b>	<b>-BK02*</b> Nitro Black (formerly -NB Modern Black)	<b>+\$0</b>
<b>TY618</b> <b>Management Synchro (-1)</b> • 3 Position tilt lock • Tilt tension	<b>+\$878</b>	<b>-TYS</b> • Seat: 19"w	<b>+\$0</b>		<b>-AR81</b> <b>Polished Aluminum Loop Top Arm</b> • Fixed height • Width adjustable <b>+\$205</b>		<b>-GR07*</b> Ash Grey (formerly -TG Palladium Grey)	<b>+\$0</b>	<b>-GR07*</b> Ash Grey (formerly -NG Palladium Grey)	<b>+\$0</b>
<b>TY628</b> <b>Executive Synchro (-2)</b> • 5 position tilt lock • Side-mounted tilt tension • Independent back angle	<b>+\$1,046</b>	<b>-TYF</b> • Seat: 20.75"w	<b>+\$0</b>		<b>-AR485</b> (3D motion) <b>Polished Aluminum Loop Top Arm</b> • Height and width adjustable • Pivoting motion <b>+\$349</b>		<b>-WT05*</b> Frost White (formerly -TW Arctic White)	<b>+\$0</b>	<b>-WT05*</b> Frost White (formerly -NW Arctic White)	<b>+\$0</b>
<b>TY64a8</b> <b>Quick-Adjust Synchro (Simple) (-4a)</b> -5 Tilt Range Limiter Positions -7 Tilt Tension Quick Adjust	<b>+\$938</b>				<b>Other Group 1 or Group 4 Arms</b> Write in choice		<b>-BL03</b> Bay Marine (formerly -TM)	<b>+\$25</b>	<b>-BL03</b> Bay Marine (formerly -NM)	<b>+\$0</b>
<b>TY64b8</b> <b>Quick-Adjust Synchro (Advanced) (-4b)</b> -5 Tilt Range Limiter Positions -7 Tilt Tension Quick Adjust -Independent Back Angle -Forward Seat Angle	<b>+\$1,000</b>						<b>-GN02</b> Lemongrass (formerly -TL)	<b>+\$25</b>	<b>-GN02</b> Lemongrass (formerly -NL)	<b>+\$0</b>
<b>TY668</b> <b>Body-Activated Motion (-6)</b> • 3 Position tilt lock	<b>+\$878</b>						<b>-GR02</b> Warm Slate (formerly -TS)	<b>+\$25</b>	<b>-GR02</b> Warm Slate (formerly -NS)	<b>+\$0</b>
<b>TY67b8</b> <b>Simple Multi-Function (-7b)</b> • Infinite seat tilt/lock (free-float) • Infinite back tilt/Lock	<b>+\$898</b>						nameplate		<b>-THR</b> Headrest <sup>2</sup>	<b>+\$236</b>
<b>TY68b8</b> <b>Full Multi-Function (-8b)</b> • Seat/back tilt and lock • Rocking seat tilt (free-float) • Tilt tension • Infinite forward-tilt seat angle	<b>+\$949</b>									

\*Color code/name change only. There is no color change to the Polyback Color.

\*Color code/name change only. There is no color change to the Nameplate Color.

<sup>2</sup> Polished aluminum headrest frame with laser-etched Truly. logo. Upholstered in Grade 3 leather-like material.

Note: Headrest not available with Jacket

**OTHER OPTIONS** (append to above nomenclature to add to, or override existing options)

Memory Foam		Casters		Yoke Color		Fire Barrier	
Code	List	Code	List	Code	List	Code	List
<b>-CFT</b> Memory foam sub-layer (enhanced padding)	<b>\$66</b>	<b>-65MS</b> (formerly -SC) 65mm Grey two-tone multi-surface soft caster	<b>\$25</b>	<b>-BLK</b> Black Powdercoat	<b>+\$0</b>	<b>-TB133-1</b> Fire barrier for TB133 (without backrest upholstery; seat only.)	<b>+\$80</b>
		<b>-50R</b> (formerly -REV) 50mm reverse braking caster, restricts chair movement when chair IS in use	<b>\$35</b>	<b>-PLH</b> Polished Aluminum	<b>+\$0</b>	<b>-TB133-3</b> Fire barrier for the FULL seat and Jacket/Wrap to be made using TB133.	<b>+\$158</b>
		<b>-GLDR</b> Glides	<b>\$0</b>				
<b>Cylinder</b>							
Code	List						
<b>-5AF</b> Black 5" cylinder raises seat height to (19" - 24")	<b>+\$0</b>						



Note: TB133 is an option only in select States where it is not banned due to potentially health-adverse reasons. Verify with your state, and client, to ensure this option is truly needed and permitted before ordering.

## MODEL CODE

Example: **TY618 - TYS - N - BK02 - BK02 - PBK - 2570 - STDB** (new format) = **TY618 - TYS - N - TB - NB - etc.** (original format)

Model #	Seat size	Arm	Polyback	Name-plate	Back uph.	Seat uph.	Package	Model & mech.	Seat size	Arm	PB	NP
---------	-----------	-----	----------	------------	-----------	-----------	---------	---------------	-----------	-----	----	----

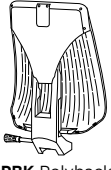
6. Back Upholstery Options Fabric Application Testing Required		
Code	List	
<b>-PBK</b> Polyback, not upholstered	<b>+\$0</b>	
Choose <b>-J</b> for Jacket or <b>-W</b> for wrap, then <b>-Color #</b>	Jacket List	Wrap List
• <b>Grade 1 / C.O.M.</b>	<b>+\$86</b>	<b>N/A</b>
• <b>Grade 2 / Grade-in A</b>	<b>+\$126</b>	<b>+\$69</b>
• <b>Grade 3 / Grade-in B</b>	<b>+\$166</b>	<b>+\$119</b>
• <b>Grade 4 / Grade-in C</b>	<b>+\$186</b>	<b>+\$129</b>
• <b>Grade 5 / Grade-in D</b>	<b>+\$206</b>	<b>+\$139</b>
• <b>Grade 6 / Grade-in E</b>	<b>+\$226</b>	<b>+\$189</b>
• <b>LG1 Evita</b>	<b>N/A</b>	<b>N/A</b>
• <b>LG2 Lena - LDEL, LLUT, LORC only*</b>	<b>+\$239</b>	<b>+\$229</b>
• <b>LG3 Vulcano - LMIT, LSTG only*</b>	<b>+\$249</b>	<b>+\$239</b>

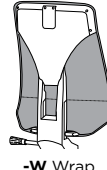
Note: not all patterns are available for J- and W-. Please check page 146 (or with factory) for availability list.

\*For NON In-Stock colors, check with OM Seating for additional pricing details.

7. Seat Upholstery Options	
Code	List
• <b>Grade 1 / C.O.M.</b>	<b>\$0</b>
• <b>Grade 2 / Grade-in A</b>	<b>+\$15</b>
• <b>Grade 3 / Grade-in B</b>	<b>+\$30</b>
• <b>Grade 4 / Grade-in C</b>	<b>+\$45</b>
• <b>Grade 5* / Grade-in D</b>	<b>+\$60</b>
• <b>Grade 6 / Grade-in E</b>	<b>+\$75</b>
• <b>LG1 Evita / C.O.L.</b>	<b>+\$135</b>
• <b>LG2 Lena - LDEL, LLUT, LORC only**</b>	<b>+\$150</b>
• <b>LG3 Vulcano - LMIT, LSTG only**</b>	<b>+\$155</b>

\* Grade 5 knit patterns will not have standard Truly.\* stitching detail.

\*\*For NON In-Stock colors, check with OM Seating for additional pricing details.

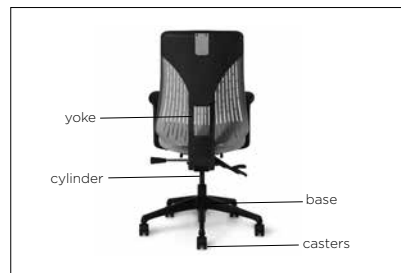

8. Base Packages (includes cylinder, base, and casters)	
Code	List
Black Packages	
<b>-XSB (NEW!) Low Seat Height Package</b> (Seat height: 15.5" - 19.5") • <b>Yoke:</b> Black powdercoat • <b>Cylinder:</b> 4" Black (4HD) • <b>Base:</b> 27" Black powdercoated aluminum (27BYS) • <b>Casters:</b> 55mm Truly. multi-surface soft casters (55MSTY)	<b>\$0</b>
<b>-STDB Standard Seat Height Package</b> (Seat height: 17" - 22") • <b>Yoke:</b> Black powdercoat • <b>Cylinder:</b> 5" Black (5BTY) • <b>Base:</b> 27" Black nylon (27BTY) • <b>Casters:</b> 55mm Truly. multi-surface soft casters (55MSTY)	<b>+\$0</b>
Polished Packages	
<b>-XSP (NEW!) Low Seat Height Package</b> (Seat height: 15.5" - 19.5") • <b>Yoke:</b> Polished aluminum • <b>Cylinder:</b> 4" Black (4HD) • <b>Base:</b> 27" Polished aluminum (27PYS) • <b>Casters:</b> 55mm Truly. multi-surface soft casters (55MSTY)	<b>+\$55.56</b>
<b>-STDP Standard Seat Height Package</b> (Seat height: 17" - 22") • <b>Yoke:</b> Polished aluminum • <b>Cylinder:</b> 5" Chrome (5CTY) • <b>Base:</b> 27" Polished aluminum (27PTY) • <b>Casters:</b> 55mm Truly. multi-surface soft casters (55MSTY)	<b>+\$20</b>



Dimensions	W	D	H
Overall	27"	27"	38.25".47.5"
Seat (standard)	19"	17.5"-20.6"	24"
Seat (petite)	18"	16.5"-19.6"	24"
Seat (full)	20.75"	18"-21.1"	24"
Back	20"	N/A	24"

Travel Range (height)		4.25" back	5" seat
Upholstery	Back	Seat	Backshell
COM*	N/A	1 yd.	N/A
Shipping	Carton Wt.	FedEx Wt.	
	70 lbs.	101 lbs.	

\*for big pattern repeats, check with OM



# Truely.® Task Stool (TY6-TS)



Workstations | Lab

### Truely. Core Features:

- TruFit™ System (self-conforming back)
- EZ-back height adjustment
- Lumbar depth adjustment
- 300 lb. Weight Capacity
- Lifetime Limited Warranty



Note: Green font color indicates default build for "most popular" configuration of this spread.



1. Model		2. Seat Size		3. Arms		4. Polyback Color		5. Truely.® Nameplate Color		
Code	List	Code	List	Code	List	Code	List		List	
<b>TY60gs8-TS</b> <b>Guest Swivel</b> • Seat height adjustment only	<b>\$954</b>	<b>-TYP</b> • Seat: 18"w	<b>+\$0</b>		<b>-N</b> (No arms) <b>\$0</b>		<b>-BK02*</b> Nitro Black <i>(formerly -TB Modern Black)</i>	<b>+\$0</b>	<b>-BK02*</b> Nitro Black <i>(formerly -NB Modern Black)</i>	<b>+\$0</b>
<b>TY67b8-TS</b> <b>Simple multi-function</b> • Infinite seat tilt/lock (free-float) • Infinite back tilt/lock	<b>\$1,031</b>	<b>-TYS</b> • Seat: 19"w	<b>+\$0</b>		<b>-AR81</b> <b>Polished Aluminum Loop Top Arm</b> • Fixed height • Width adjustable <b>+\$205</b>		<b>-GR07*</b> Ash Grey <i>(formerly -TG Palladium Grey)</i>	<b>+\$0</b>	<b>-GR07*</b> Ash Grey <i>(formerly -NG Palladium Grey)</i>	<b>+\$0</b>
		<b>-TYF</b> • Seat: 20.75"w	<b>+\$0</b>		<b>-AR485</b> (3D motion) <b>Polished Aluminum Loop Top Arm</b> • Height adjustable • Width adjustable • Pivoting motion <b>+\$349</b>		<b>-WT05*</b> Frost White <i>(formerly -TW Arctic White)</i>	<b>+\$0</b>	<b>-WT05*</b> Frost White <i>(formerly -NW Arctic White)</i>	<b>+\$0</b>
					<b>Other Group 1 or Group 4 Arms</b> Write in choice		<b>-BL03</b> Bay Marine <i>(formerly -TM)</i>	<b>+\$25</b>	<b>-BL03</b> Bay Marine <i>(formerly -NM)</i>	<b>+\$0</b>
							<b>-GN02</b> Lemongrass <i>(formerly -TL)</i>	<b>+\$25</b>	<b>-GN02</b> Lemongrass <i>(formerly -NL)</i>	<b>+\$0</b>
							<b>-GR02</b> Warm Slate <i>(formerly -TS)</i>	<b>+\$25</b>	<b>-GR02</b> Warm Slate <i>(formerly -NS)</i>	<b>+\$0</b>



\*Color code/name change only. There is no color change to the Nameplate Color.

<sup>2</sup> Polished aluminum headrest frame with laser-etched Truely. logo. Upholstered in Grade 3 leather-like material.

### OTHER OPTIONS (append to above nomenclature to add to, or override existing options)

Memory Foam		Casters		Yoke Color		Fire Barrier	
Code	List	Code	List	Code	List	Code	List
<b>-CFT</b> Memory foam sub-layer (enhanced padding)	<b>+\$66</b>		<b>-65MS</b> <i>(formerly -SC)</i> 65mm Grey two-tone multi-surface soft caster <b>+\$25</b>	<b>-BLK</b> Black Powdercoat	<b>+\$0</b>	<b>-TB133-1</b> Fire barrier for TB133 (without backrest upholstery; seat only.)	<b>+\$80</b>
			<b>-50R</b> <i>(formerly -REV)</i> 50mm reverse braking caster, restricts chair movement when chair IS in use <b>+\$35</b>	<b>-PLH</b> Polished Aluminum	<b>+\$0</b>	<b>-TB133-3</b> Fire barrier for the FULL seat and Jacket/ Wrap to be made using TB133.	<b>+\$158</b>
			<b>-GLDR</b> Glides <b>+\$0</b>				

Note: TB133 is an option only in select States where it is not banned due to potentially health-adverse reasons. Verify with your state, and client, to ensure this option is truly needed and permitted before ordering.



## MODEL CODE

Example: **TY67b8-TS - TYS - N - BK02 - BK02 - PBK - 2570 - STDB** (new format) = **TY673 - TYS - N - TB - etc.** (original format)

Model #	Seat size	Arm	Polyback	Name-plate	Back uph.	Seat uph.	Package	Model & mech.	Seat size	Arm	PB
---------	-----------	-----	----------	------------	-----------	-----------	---------	---------------	-----------	-----	----

6. Back Upholstery Options Fabric Application Testing Required		
Code	List	
<b>-PBK</b> Polyback, not upholstered	<b>+\$0</b>	
Choose <b>-J</b> for Jacket or <b>-W</b> for wrap, then <b>-Color #</b>	Jacket List	Wrap List
• Grade 1 / C.O.M.	<b>+\$86</b>	<b>N/A</b>
• Grade 2 / Grade-in A	<b>+\$126</b>	<b>+\$69</b>
• Grade 3 / Grade-in B	<b>+\$166</b>	<b>+\$119</b>
• Grade 4 / Grade-in C	<b>+\$186</b>	<b>+\$129</b>
• Grade 5 / Grade-in D	<b>+\$206</b>	<b>+\$139</b>
• Grade 6 / Grade-in E	<b>+\$226</b>	<b>+\$189</b>
• LG1 Evita	<b>N/A</b>	<b>N/A</b>
• LG2 Lena - LDEL, LLUT, LORC only*	<b>+\$239</b>	<b>+\$229</b>
• LG3 Vulcano - LMIT, LSTG only*	<b>+\$249</b>	<b>+\$239</b>

		
<b>-PBK Polyback</b>	<b>-J Jacket</b>	<b>-W Wrap</b>

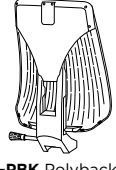
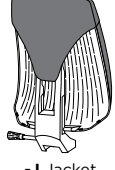
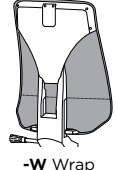
Note: not all patterns are available for J- and W-. Please check page 146 (or with factory) for availability list.

\*For NON In-Stock colors, check with OM Seating for additional pricing details.

7. Seat Upholstery Options Fabric Application Testing Required	
Code	List
• Grade 1 / C.O.M.	<b>\$0</b>
• Grade 2 / Grade-in A	<b>+\$15</b>
• Grade 3 / Grade-in B	<b>+\$30</b>
• Grade 4 / Grade-in C	<b>+\$45</b>
• Grade 5* / Grade-in D	<b>+\$60</b>
• Grade 6 / Grade-in E	<b>+\$75</b>
• LG1 Evita / C.O.L.	<b>+\$135</b>
• LG2 Lena - LDEL, LLUT, LORC only**	<b>+\$150</b>
• LG3 Vulcano - LMIT, LSTG only**	<b>+\$155</b>

\*Grade 5 knit patterns will not have standard Truly.\* stitching detail.

\*\*For NON In-Stock colors, check with OM Seating for additional pricing details.

8. Base Packages (includes cylinder, base, and casters)	
Code	List
<b>-8TLB</b> <b>Standard Stool Height with Adjustable Footring (Black)</b> (Seat height: 23" - 31") • Yoke: Black powdercoat • Cylinder: 8" Black (8BAT) • Footring: 20" Turn-lock (20TLP) • Base: 27" Black nylon (27BTY) • Casters: 55mm Truly. multi-surface soft casters (55MSTY)	<b>\$0</b>
<b>-8TLP</b> <b>Standard Stool Height with Adjustable Footring (Polished)</b> (Seat height: 23" - 31") • Yoke: Polished aluminum • Cylinder: 8" Chrome (8CHD) • Footring: 20" Turn-lock (20TL) • Base: 27" Polished aluminum (27PTY) • Casters: 55mm Truly. multi-surface soft casters (55MSTY)	<b>+\$0</b>
<b>-8GSPC</b> <b>Standard Stool Height with Fixed Footring</b> (Seat height: 26.5" - 33.5") • Yoke: Polished aluminum • Cylinder: 8" Chrome (8CHD) • Base/Footing: 22" Chrome fixed footring (22GSP) • Casters: 65mm Grey two-tone multi-surface (65MS)	<b>-\$75</b>

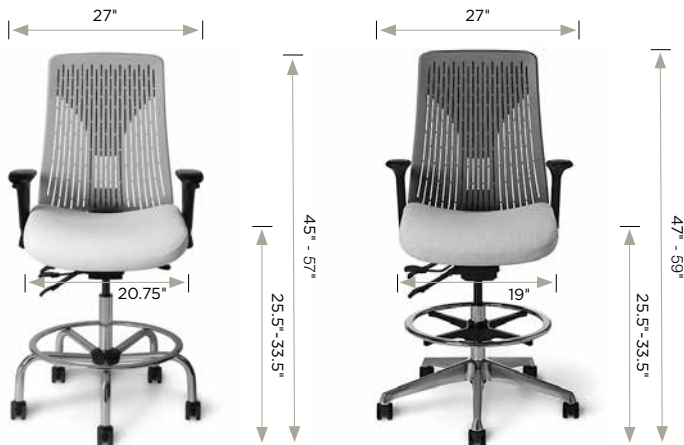

Dimensions are the same for TY673 (GSP base) and TY675 (Turnlock base) except the overall height and seat height.

Dimensions (TY673 & TY675)	W	D	H (TY673 w/GSP)	H (TY675 w/ Turnlock)
Overall	27"	27"	45" - 57"	47" - 59"
Seat (standard)	19"	17.5" - 20.6"	25.5" - 33.5"	23" - 31"
Seat (petite)	18"	16.5" - 19.6"	25.5" - 33.5"	23" - 31"
Seat (full)	20.75"	18" - 21.1"	25.5" - 33.5"	23" - 31"
Back	20"	N/A	24"	

Travel Range (height)	4.25" back	8" seat	
Upholstery	Back	Seat	Backshell
COM*	N/A	1 yd	N/A
Shipping	Carton Wt.	FedEx Wt.	
	70 lbs.	101 lbs.	

\*for big pattern repeats, check with OM



# Werksy®

## Features:

- Begins @ \$504 (WY2-G)
- Multi-faceted shell chair that features 3 different modes to fit the way you work!
- Visitor: Not your average guest chair – elegant lines to dress up any waiting/guest area
- Tasker: Simple tasking with flair – tilt motion seat for training & hoteling stations
- Rocker: Add a little play to your day – Height adjustable rocker with an auto-return cylinder!
- Designed by Henner Jahns of Gecco Vision







# Werksy® Guest (WY2-G)

Visitor | Guest seating

### Werksy Guest Core Features:

- One piece shell chair
- Standard with glides
- Floor stacks 4 high (underseat cover protects seats)
- 300 lb. Weight Capacity
- Lifetime Limited Warranty

**Note:** Green font color indicates default build for "most popular" configuration of this spread.

1. Model		2. Polyshell Color		3. Upholstery <i>NOT available without upholstery</i>			4. Frame Finish		
Code	List	Code		List	Code	Seat (S-) List	Full (F-)** List	Code	List
<b>WY2-G</b>	<b>\$504</b>		<b>-BK01</b> Modern Black (formerly -PSB)*	<b>+\$0</b>	<b>• Grade 1 / C.O.M.</b>	<b>+\$0</b>	<b>+\$33</b>	<b>-BLK</b> Black powdercoat	<b>+\$0</b>
			<b>-GR08</b> Noble Grey (formerly -PSG Palladium Grey)*	<b>+\$25</b>	<b>• Grade 2 / Grade-in A</b>	<b>+\$10</b>	<b>+\$53</b>	<b>-GRY</b> Grey powdercoat	<b>+\$0</b>
			<b>-WT06</b> Silk White (formerly -PSW Arctic White)*	<b>+\$25</b>	<b>• Grade 3 / Grade-in B</b>	<b>+\$20</b>	<b>+\$73</b>	<b>-CHM</b> Chrome	<b>+\$30</b>
Please contact an OM representative for color chips.					<b>• Grade 4 / Grade-in C</b>	<b>+\$30</b>	<b>+\$93</b>		
* Color code/name change only. There is NO change to actual color of the original polyshell.					<b>• Grade 5 / Grade-in D</b>	<b>+\$40</b>	<b>+\$113</b>		
					<b>• Grade-in E</b>	<b>+\$50</b>	<b>+\$133</b>		
					<b>• Werksy Quilt</b>	<b>+\$69</b>	<b>+\$135</b>		
					<b>• LG1 Evita / C.O.L.</b>	<b>+\$110</b>	<b>+\$210</b>		
					<b>• LG2 Lena - LDEL, LLUT, LORC only*</b>	<b>+\$120</b>	<b>+\$220</b>		
					<b>• LG3 Vulcano - LMIT, LSTG only*</b>	<b>+\$130</b>	<b>+\$240</b>		
					<b>Seat Upholstery</b>	<b>Full Upholstery</b>			
									

\*For NON In-Stock colors, check with OM Seating for additional pricing details.

\*\*Note: Fabric: Application Testing Required on non-approved materials for full (-F) upholstery option.

**MODEL CODE**

Example: WY2-G - BK01 - S-2570 - BLK (new format) = WY2G - PSB - S-2570 - BLK - GLD (original formula)

Model #	Polyshell finish	Uph.	Frame finish	Model #	Polyshell	Full uph.	Frame finish	Other options
---------	---------------------	------	-----------------	---------	-----------	--------------	-----------------	------------------

\* For even more options, please refer to penultimate page of this price guide.

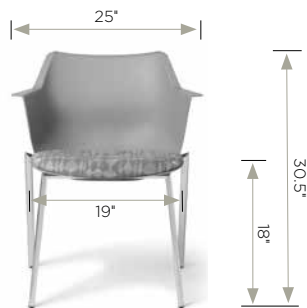

Dimensions	W	D	H
Overall	25"	25"	30.5"
Seat	19"	18.5"	18"
Back	14"	N/A	15"

Upholstery	Seat	Full
COM	0.75 yd.	1.5 yds.
Shipping	Carton Wt.	FedEx Wt.
	35 lbs.	195 lbs.



# Werksy® 4-Star (WY2-4S)

NEW model code

### Werksy 4-Star Core Features:

- One piece shell chair
- Simple, Rocking-tilt mechanism
- 300 lb. Weight Capacity
- Lifetime Limited Warranty

**Note:** Green font color indicates default build for "most popular" configuration of this spread.

1. Model		2. Mechanism		3. Polyshell Color	
Code	List	Code	List	Code	List
<b>WY2-4S</b> NEW model code	<b>\$527</b>	<b>-GSb</b> (formerly WY1GL) <b>Guest Swivel</b> • Height Adjustable	<b>+\$0</b>	<b>-BK01</b> Modern Black (formerly -PSB)*	<b>+\$0</b>
		<b>-T1a</b> (formerly WY2GL) <b>Tilt Mechanism</b> • Height Adjustable • Light tilt motion	<b>+\$28</b>	<b>-GR08</b> Noble Grey (formerly -PSG Palladium Grey)*	<b>+\$25</b>
				<b>-WT06</b> Silk White (formerly -PSW Arctic White)*	<b>+\$25</b>

Please contact an OM representative for color chips.

\* Color code/name change only. There is NO change to actual color of the original polyshell.

## MODEL CODE

Example: **WY2-4S - T1a - BK01 - S-2570 - STDB** (new format) = **WY2GL - PSB - S-2570 - WB5 - SP-B** (original format)

Model #    Mech.    Polyshell    Uph.    Base pkg.    Model #    Polyshell    Uph.    Cylinder    Base pkg.

4. Upholstery <i>NOT available without upholstery</i>		
Code	Seat (S-) List	Full (F-) List
• Grade 1 / C.O.M.	+\$0	+\$33
• Grade 2 / Grade-in A	+\$10	+\$53
• Grade 3 / Grade-in B	+\$20	+\$73
• Grade 4 / Grade-in C	+\$30	+\$93
• Grade 5 / Grade-in D	+\$40	+\$113
• Grade-in E	+\$50	+\$133
• Werksy Quilt	+\$69	+\$135
• LG1 Evita / C.O.L.	+\$110	+\$210
• LG2 Lena - LDEL, LLUT, LORC only*	+\$120	+\$220
• LG3 Vulcano - LMIT, LSTG only*	+\$130	+\$240
Seat Upholstery		Full Upholstery
		

\*For NON In-Stock colors, check with OM Seating for additional pricing details.

Note: Fabric Application Testing Required on non-approved materials for full (-F) upholstery option.

5. Base Packages (includes cylinder, base, and casters)	
Code	List
-STDB (formerly -SP-B) <b>Standard Seat Height Package (Black)</b> (Seat height: 16.5" - 20.5") • Cylinder: 4" Black (4BCE) • Base: 4-star black (27BL4)	+\$0
-STDP (formerly -SP-P) <b>Standard Seat Height Package (Polished)</b> (Seat height: 16.5" - 20.5") • Cylinder: 4" Chrome (4CCE) • Base: 4-star Polished (27PL4)	+\$20
Fixed Height Base Packages	
-FHB <b>Fixed Height Package (Black)</b> (Seat height: 18.5") • Cylinder: 5" Black (5BCE) • Base: 4-star Black (27BL4)	+\$20
-FHP <b>Fixed Height Package (Polished)</b> (Seat height: 18.5") • Cylinder: 5" Chrome (5PCE) • Base: 4-star Polished (27PL4)	+\$40

\* For even more options, please refer to penultimate page of this price guide.

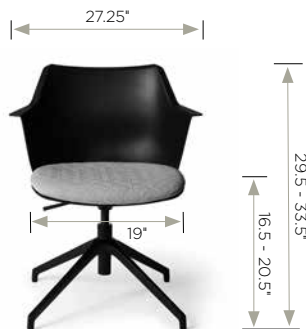

Dimensions	W	D	H
Overall	27.25"	27.25"	29.5" - 33.5"
Seat	19"	18.5"	16.5"-20.5"
Back	14"	N/A	15"

Upholstery	Seat	Full
COM	0.75 yd.	1.5 yds.
Shipping	Carton Wt.	FedEx Wt.
	36 lbs.	101 lbs.



# Werksy® Multi-tasker (WY2-T)

Hoteling | Light Multi-tasking

## Werksy Multi-tasker Core Features:

- One piece shell chair
- Simple, Rocking-tilt mechanism
- 300 lb. Weight Capacity
- Lifetime Limited Warranty



**Note:** Green font color indicates default build for "most popular" configuration of this spread.

1. Model		2. Mechanism		2. Polyshell Color	
Code	List	Code	List	Code	List
<b>WY2-T</b>	<b>\$504</b>	<b>-GSb</b> (formerly WY1T) <b>Guest Swivel</b> • Height Adjustable	<b>+\$0</b>	<b>-BK01</b> Modern Black (formerly -PSB)*	<b>+\$0</b>
		<b>-T1a</b> (formerly WY2T) <b>Tilt Mechanism</b> • Height Adjustable • Light tilt motion	<b>+\$28</b>	<b>-GR08</b> Noble Grey (formerly -PSG Palladium Grey)*	<b>+\$25</b>
				<b>-WT06</b> Silk White (formerly -PSW Arctic White)*	<b>+\$25</b>

Please contact an OM representative for color chips.

\* Color code/name change only. There is NO change to actual color of the original polyshell.

## OTHER OPTIONS (append to above nomenclature to add to, or override existing options)

Casters and Glides		List
	<b>-50SS</b> (formerly -SS) 50mm safety soft casters (minimizes chair movement when <b>NOT</b> in use.)	<b>+\$25</b>
	<b>-50R</b> (formerly -REV) 50mm reverse braking caster (restricts chair movement when chair <b>IS</b> in use.)	<b>+\$35</b>
	<b>-GLDR</b> (formerly -G) Glides	<b>+\$0</b>



## MODEL CODE

Example: **WY2-T - T1a - BK01 - S-2570 - SPDB** (new format) = **WY2T - PSB - S-2570 - WB5 - WB25 - 55MSB** (original format)

Model #   Mech.   Polyshell   Uph.   Base pkg.   Model #   Polyshell   Uph.   Cylinder   Base   Caster

4. Upholstery <i>NOT available without upholstery</i>		
Code	Seat (S-) List	Full (F-) List
• Grade 1 / C.O.M.	+\$0	+\$33
• Grade 2 / Grade-in A	+\$10	+\$53
• Grade 3 / Grade-in B	+\$20	+\$73
• Grade 4 / Grade-in C	+\$30	+\$93
• Grade 5 / Grade-in D	+\$40	+\$113
• Grade-in E	+\$50	+\$133
• Werksy Quilt	+\$69	+\$135
• LG1 Evita / C.O.L.	+\$110	+\$210
• LG2 Lena - LDEL, LLUT, LORC only*	+\$120	+\$220
• LG3 Vulcano - LMIT, LSTG only*	+\$130	+\$240
<div style="display: flex; justify-content: space-around;"> <div style="text-align: center;"> <p>Seat Upholstery</p>  </div> <div style="text-align: center;"> <p>Full Upholstery</p>  </div> </div>		

\*For NON In-Stock colors, check with OM Seating for additional pricing details.

Note: Fabric Application Testing Required on non-approved materials for full (-F) upholstery option.

5. Base Packages (includes cylinder, base, and casters)	
Code	List
<b>-STDB</b> <b>Standard Seat Height Package (Black)</b> (Seat height: 16" - 21") <ul style="list-style-type: none"> <li>• Cylinder: 5" Black (5BWY)</li> <li>• Base: 25" Black powdercoat (25BWY)</li> <li>• Casters: 55mm Black two-tone multi-surface (55MSB)</li> </ul>	+\$0
<b>-STDP</b> <b>Standard Seat Height Package (Polished)</b> (Seat height: 16" - 21") <ul style="list-style-type: none"> <li>• Cylinder: 5" Black (5BWY)</li> <li>• Base: 25" Two-tone polished aluminum (25PWY)</li> <li>• Casters: 55mm Black two-tone multi-surface (55MSB)</li> </ul>	+\$30
<b>-STDW</b> <b>Standard Seat Height Package (White)</b> (Seat height: 16" - 21") <ul style="list-style-type: none"> <li>• Cylinder: 5" White (5WWY)</li> <li>• Base: 25" White powdercoat (25WWY)</li> <li>• Casters: 55mm White two-tone multi-surface (55MSW)</li> </ul>	+\$40

\* For even more options, please refer to penultimate page of this price guide.

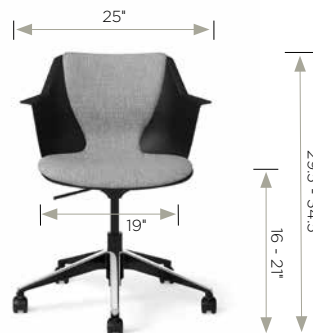

Dimensions	W	D	H
Overall	25"	25"	29.5 - 34.5"
Seat	19"	18.5"	16-21"
Back	14"	N/A	15"

Upholstery	Seat	Full
COM	0.75 yd.	1.5 yds.
Shipping	Carton Wt.	FedEx Wt.
	36 lbs.	101 lbs.



# Werksy® Stool (WY2-TS)

## Light Multi-tasker Stool

### Werksy Stool Core Features:

- One piece shell chair
- Simple, light multi-tasker stool
- 300 lb. Weight Capacity
- Lifetime Limited Warranty



**Note:** Green font color indicates default build for "most popular" configuration of this spread.

1. Model		2. Mechanism		2. Polyshell Color	
Code	List	Code	List	Code	List
WY2-TS	\$622	-GSb <b>Fixed Mechanism</b> • Height Adjustable	+\$0	-BK01 Modern Black (formerly -PSB)*	+\$0
				-GR08 Noble Grey (formerly -PSG Palladium Grey)*	+\$25
				-WT06 Silk White (formerly -PSW Arctic White)*	+\$25

Please contact an OM representative for color chips.

\* Color code/name change only. There is NO change to actual color of the original polyshell.

### OTHER OPTIONS (append to above nomenclature to add to, or override existing options)

Casters and Glides		List
	-50SS (formerly -SS) 50mm safety soft casters (minimizes chair movement when <b>NOT</b> in use.)	+\$25
	-50R (formerly -REV) 50mm reverse braking casters (restricts chair movement when chair <b>IS</b> in use.)	+\$35
	-GLDR (formerly -G) Glides	+\$0

## MODEL CODE

Example: **WY2-TS - GSb - BK01 - F-2570 - 10TLB** (new format) = **WY1T - PSB - F-2570 - OC10 - B27TL - SC** (original format)

Model #    Mech.    Polyshell    Uph.    Base pkg.    Model #    Polyshell    Uph.    Cylinder    Base    Caster

4. Upholstery <i>NOT available without upholstery</i>		
Code	Seat (S-) List	Full (F-) List
• Grade 1 / C.O.M.	+\$0	+\$33
• Grade 2 / Grade-in A	+\$10	+\$53
• Grade 3 / Grade-in B	+\$20	+\$73
• Grade 4 / Grade-in C	+\$30	+\$93
• Grade 5 / Grade-in D	+\$40	+\$113
• Grade-in E	+\$50	+\$133
• Werksy Quilt	+\$69	+\$135
• LG1 Evita / C.O.L.	+\$110	+\$210
• LG2 Lena - LDEL, LLUT, LORC only*	+\$120	+\$220
• LG3 Vulcano - LMIT, LSTG only*	+\$130	+\$240
<div style="display: flex; justify-content: space-around;"> <div style="text-align: center;"> <p>Seat Upholstery</p>  </div> <div style="text-align: center;"> <p>Full Upholstery</p>  </div> </div>		

\*For NON In-Stock colors, check with OM Seating for additional pricing details.

Note: Fabric Application Testing Required on non-approved materials for full (-F) upholstery option.

5. Base Packages (includes cylinder, base, and casters)	
Code	List
<b>Black Base Packages:</b>	
<b>-8TLB</b> <b>Low Stool Height Package (Black)</b> (Seat height: 21" - 29") <ul style="list-style-type: none"> <li>• <b>Cylinder:</b> 8" Black (8BAT)</li> <li>• <b>Footring:</b> 20" Turn-lock footring (20TL)</li> <li>• <b>Base:</b> 27" Black nylon (27BM)</li> <li>• <b>Casters:</b> 65mm Grey two-tone multi-surface (65MS)</li> </ul>	+\$0
<b>-10TLB</b> <b>Standard Stool Height Package (Black)</b> (Seat height: 25" - 35") <ul style="list-style-type: none"> <li>• <b>Cylinder:</b> 10" Chrome (10CHD)</li> <li>• <b>Footring:</b> 20" Turn-lock footring (20TL)</li> <li>• <b>Base:</b> 27" Black nylon (27BM)</li> <li>• <b>Casters:</b> 65mm Grey two-tone multi-surface (65MS)</li> </ul>	+\$0
<b>Polished Base Packages:</b>	
<b>-8TLP</b> <b>Low Stool Height Package (Polished)</b> (Seat height: 21" - 29") <ul style="list-style-type: none"> <li>• <b>Cylinder:</b> 8" Chrome (8CHD)</li> <li>• <b>Footring:</b> 20" Turn-lock footring (20TL)</li> <li>• <b>Base:</b> 27" Polished aluminum (27PM)</li> <li>• <b>Casters:</b> 65mm Grey two-tone multi-surface (65MS)</li> </ul>	+\$40
<b>-10TLP</b> <b>Standard Stool Height Package (Polished)</b> (Seat height: 25" - 35") <ul style="list-style-type: none"> <li>• <b>Cylinder:</b> 10" Chrome (10CHD)</li> <li>• <b>Footring:</b> 20" Turn-lock footring (20TL)</li> <li>• <b>Base:</b> 27" Polished aluminum (27PM)</li> <li>• <b>Casters:</b> 65mm Grey two-tone multi-surface (65MS)</li> </ul>	+\$40

\* For even more options, please refer to penultimate page of this price guide.



Dimensions	W	D	H
Overall	27"	27"	38.5 - 48.5"
Seat	19"	18.5"	25-35"
Back	14"	N/A	15"

Upholstery	Seat	Full
COM	0.75 yd.	1.5 yds.
Shipping	Carton Wt.	FedEx Wt.
	36 lbs.	101 lbs.





# Werksy® Rocker (WY2-R)

Rocker | Hoteling | Guest seating

### Werksy Rocker Core Features:

- One piece shell rocking chair
- Auto-return rocker
- 300 lb. Weight Capacity
- 12 Year Warranty

**Note:** Green font color indicates default build for "most popular" configuration of this spread.

1. Model		2. Mechanism		2. Polysell Color	
Code	List	Code	List	Code	List
<b>WY2-R</b>	<b>\$836</b>	<b>-GSb</b> <b>Fixed Mechanism</b> • Height Adjustable	<b>+\$0</b>	 <b>-BK01</b> Modern Black (formerly -PSB)*	<b>+\$0</b>
				 <b>-GR08</b> Noble Grey (formerly -PSG Palladium Grey)*	<b>+\$25</b>
				 <b>-WT06</b> Silk White (formerly -PSW Arctic White)*	<b>+\$25</b>

Please contact an OM Representative for color chips.

\* Color code/name change only. There is NO change to actual color of the original polysell.

## MODEL CODE

Example: **WY2-R - GSb - BK01 - S-2570 - RKB** (new format) = **WY2R - PSB - S-2570 - WBA5 - BLK** (original format)

Model #    Mech.    Polyshell    Uph.    Base pkg.                      Model #    Polyshell    Uph.    Cylinder    Rocker pkg.

3. Upholstery <i>NOT available without upholstery</i>		
Code	Seat (S-) List	Full (F-) List
• Grade 1 / C.O.M.	+\$0	+\$33
• Grade 2 / Grade-in A	+\$10	+\$53
• Grade 3 / Grade-in B	+\$20	+\$73
• Grade 4 / Grade-in C	+\$30	+\$93
• Grade 5 / Grade-in D	+\$40	+\$113
• Grade-in E	+\$50	+\$133
• Werksy Quilt	+\$69	+\$135
• LG1 Evita / C.O.L.	+\$110	+\$210
• LG2 Lena - LDEL, LLUT, LORC only*	+\$120	+\$220
• LG3 Vulcano - LMIT, LSTG only*	+\$130	+\$240
Seat Upholstery		Full Upholstery
		

\*For NON In-Stock colors, check with OM Seating for additional pricing details.

Note: Fabric Application Testing Required on non-approved materials for full (-F) upholstery option.

4. Base Packages (includes cylinder, base, and casters)	
Code	List
-RKB <b>Rocker Package (Black)</b> (Seat height: 16" - 21") • Cylinder: 5" Black auto-return (5BAR) • Base: 27" Black powdercoat (27BR)	+\$0
-RKC <b>Rocker Package (Chrome)</b> (Seat height: 16" - 21") • Cylinder: 5" Black auto-return (5BAR) • Base: 27" Chrome rocker (27CR)	+\$45

\* For even more options, please refer to penultimate page of this price guide.

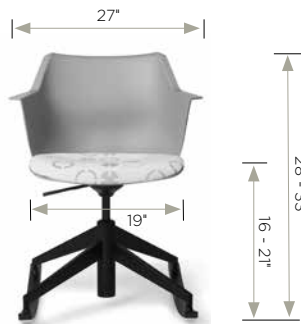

Dimensions	W	D	H
Overall	27"	27"	28 - 33"
Seat	19"	18.5"	16-21"
Back	14"	N/A	15"

Upholstery	Seat	Full
COM	0.75 yd.	1.5 yds.
Shipping	Carton Wt.	FedEx Wt.
	48 lbs.	195 lbs.



## Features:

- Begins @ \$273 armless (WS10)
- Low-maintenance and straightforward seating for shop and dirtier environments
- Self-skinned polyurethane seat/back makes for easy cleaning
- Variety of optional styles, including “Sit-Stand” stools





# WS

Specialty | Industrial | Utility Seating

Please see page 169 for options.

utility seats

Model	Description	Textile Grade-In	List	Specifications
WS10	Pneumatic lift	Black polyurethane	\$273.00	Overall width 25"
	<b>Ships 2 in a box</b>			Overall height 21" - 26"
				Back N/A
				Seat 15" w x 13" d
				Seat height 16" - 21"
				COM N/A
				Carton weight 25 pounds
				FedEx weight 33 pounds
				Arms N/A
				Warranty 7 year limited

Model	Description	Textile Grade-In	List	Specifications
WS12	Pneumatic lift	Black polyurethane	\$309.00	Overall width 25"
	Tilting seat			Overall height 22" - 27"
	<b>Ships 2 in a box</b>			Back N/A
				Seat 15" w x 13" d
				Seat height 17" - 22"
				COM N/A
				Carton weight 25 pounds
				FedEx weight 33 pounds
				Arms N/A
				Warranty 7 year limited

**SPLIT CARTON FEE \$20 NET (i.e., 2 chairs shipping in 2 cartons).**

Above weights do not include optional arm kits. ; FedEx weight is calculated using FedEx dimensional standards to determine billable weight. ; Pricing and specifications subject to change without notification.



Model	Description	Textile Grade-In	List	Specifications
 <p><b>WS15VS</b></p>	Pneumatic lift	Grade 1 / C.O.M.	\$403.00	Overall width 23"
	Tilting seat	Grade 2 / Grade-in A	\$418.00	Overall height 24" - 34"
	Unibody ring base	Grade 3 / Grade-in B	\$433.00	Back N/A
	Glides	Grade 4 / Grade-in C	\$448.00	Seat 19.5" w x 19" d
	Upholstered seat	Grade 5 / Grade-in D	\$463.00	Seat height 24" - 34"
		Grade 6 / Grade-in E	\$478.00	COM 1 yd.
	Optional 8" chrome cylinder available (approx. 19-27")	LG1 (Evita) / C.O.L.	\$538.00	Carton weight 31 pounds
		LG2 (Lena-LDEL, LLUT, LORC only)*	\$553.00	FedEx weight 33 pounds
		LG3 (Vulcano-LMIT, LSTG only)*	\$558.00	Arms N/A
	<b>Ships 2 in a box</b>			Warranty 7 year limited

\*For NON In-Stock colors, check with OM Seating for additional pricing details.

Model	Description	Textile Grade-In	List	Specifications
 <p><b>WS16</b></p>	Pneumatic lift	Black polyurethane	\$361.00	Overall width 23"
	Extra wide tilting seat			Overall height 26" - 36"
	Unibody ring base			Back N/A
	Glides			Seat 17" w x 16" d
	Convenient carry handle			Seat height 22.5" - 32.5"
				COM N/A
	Optional 8" chrome cylinder available (approx. 19-27")			Carton weight 31 pounds
				FedEx weight 33 pounds
				Arms N/A
	<b>Ships 2 in a box</b>			Warranty 7 year limited

**SPLIT CARTON FEE \$20 NET (i.e., 2 WS15 or WS16 shipping in 2 cartons).**

**NOTE** For customers who prefer an upholstered seat cushion on the basic frame of the WS16, the seat of the CLVS is available in model WS15VS.

WS15VS & WS16 can be upgraded to any size standard cylinder see page 205.

Above weights do not include optional arm kits. ; FedEx weight is calculated using FedEx dimensional standards to determine billable weight. ; Pricing and specifications subject to change without notification.

# Workstools (WS)

Specialty | Industrial | Utility Seating

Please see pages 169 and 204 for options.

utility chairs & stools

Model	Description	Textile Grade-In	List	Specifications
WS22	Pneumatic lift	Black polyurethane (armless)	\$327.00	Overall width 25"
	Pivot backrest	With BR-2 arms	\$2 N/A 0	Overall height 29" - 34"
	Back height adjustment	with BR-5 arms	\$2 N/A 0	Back 15.5" w x 12.5" h
	Back depth adjustment			Seat 17" w x 16" d
				Seat height 16" - 21"
				COM N/A
				Carton weight 34 pounds
				FedEx weight 34 pounds
				Arms BR2, BR5
				Warranty 7 year limited



Model	Description	Textile Grade-In	List	Specifications
WS23	Pneumatic lift	Black polyurethane (armless)	\$396.00	Overall width 25"
	Pivot backrest	With BR-2 arms	\$3 N/A 0	Overall height 35" - 45"
	Back height adjustment	with BR-5 arms	\$3 N/A 0	Back 15.5" w x 12.5" h
	Back depth adjustment			Seat 17" w x 16" d
	20" black footring			Seat height 21" - 31"
				COM N/A
				Carton weight 40 pounds
				FedEx weight 40 pounds
				Arms BR2, BR5
				Warranty 7 year limited



Model	Description	Textile Grade-In	List	Specifications
WS24	Pneumatic lift	Black polyurethane (armless)	\$379.00	Overall width 25"
	Pivot backrest	With BR-2 arms	\$3 N/A 0	Overall height 30" - 35"
	Back height adjustment	with BR-5 arms	\$3 N/A 0	Back 15.5" w x 12.5" h
	Tilting backrest			Seat 17" w x 16" d
	Tilting seat			Seat height 16" - 21"
				COM N/A
				Carton weight 35 pounds
				FedEx weight 35 pounds
				Arms BR2, BR5
				Warranty 7 year limited



Model	Description	Textile Grade-In	List	Specifications
WS25	Pneumatic lift	Black polyurethane (armless)	\$449.00	Overall width 26"
	Pivot backrest	With BR-2 arms	\$3 N/A 0	Overall height 36" - 49"
	Back height adjustment	with BR-5 arms	\$3 N/A 0	Back 15.5" w x 12.5" h
	Tilting backrest			Seat 17" w x 16" d
	20" black footring			Seat height 22" - 32"
	Tilting seat			COM N/A
				Carton weight 42 pounds
				FedEx weight 42 pounds
				Arms BR2, BR5
				Warranty 7 year limited









**SPLIT CARTON FEE \$20 NET.**

Above weights do not include optional arm kits. ; FedEx weight is calculated using FedEx dimensional standards to determine billable weight . ; Pricing and specifications subject to change without notification.

# Workstools (WS)

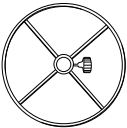
Specialty | Industrial | Utility Seating

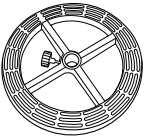
Please see page 170 for caster options.

common options	<b>Suggested Options for Workstools WS22-WS25</b>	
	<p><b>Arms</b></p>  <p><b>BR-2</b> - list: 48.00                  Width adjustable on arms                  of 2.5"                  WS Series only                  warranty</p> <p><b>discontinued on WS Series only</b></p>	 <p><b>BR-5</b> - list: 58.00                  Height &amp; width adjustable T-arms                  of 2.5"                  WS Series only                  warranty*</p> <p>Note: Version for BC85 is available upon request</p> <p><b>discontinued on WS Series only</b></p>
	<p><b>Option</b></p>  <p><b>18CR</b> (formerly FTGBC41)                  - list: 16.00 (upcharge), 59.00 (buy)                  18" chrome footring for BC, CL and WS                  (or exchange with black plastic footring)</p>	<p><b>4M</b> (formerly CYL-4M)                  - list: 13.00 (upcharge), 88.00 (buy)                  4" cylinder for BC chairs (minimum height lowered by 1", changes range to 4")</p> 
	 <p><b>20PL</b> (formerly FTG20PL)                  - list: 16.00 (upcharge), 59.00 (buy)                  20" black plastic footring for BC and WS                  (or exchange with chrome footring)</p>	<p><b>5M</b> (formerly CYL-5M)                  - list: 13.00 (upcharge), 73.00 (buy)                  5" cylinder for most of BC task and executive chairs</p> 
		<p><b>10M</b> (formerly CYL-10M)                  - list: N/A (upcharge), 102.00 (buy)                  10" cylinder: standard cylinder for BC drafting stools (range of 23-33")</p> 

Above weights do not include optional arm kits. ; FedEx weight is calculated using FedEx dimensional standards to determine billable weight. ; Pricing and specifications subject to change without notification.



# Yes

## Features:

- Begins @ \$622 armless / \$741 with KR200 arms (YS72)
- Mesh-backed chairs with upholstered seats for a wide range of work environments
- Sigh-producing soft cushions with a comfortable, mild saddle contour
- A full suite of available mechanisms to achieve any level of adjustability desired
- Timeless traditional mesh aesthetic in one of our most proven choices!



# Yes Series (YS)

Conference | Boardroom | Executive

Please see pages 176, 189 – 207 for arm kits, casters, and other options.

average / medium back

Model	Description	Textile Grade-In	List	Specifications
<b>YS72</b> 	<i>Simple Multi-Function (-7a)</i>	Grade 1 / C.O.M.	\$622.00	Overall width 27"
	Pneumatic lift	Grade 2 / Grade-in A	\$637.00	Overall height 33" - 41"
	EZ back height adjustment	Grade 3 / Grade-in B	\$652.00	Back 19" w x 20" h
	Infinitely locking seat tilt	Grade 4 / Grade-in C	\$667.00	Seat 20.5" w x 18-21.1" d
	Infinitely locking back tilt	Grade 5 / Grade-in D	\$682.00	Seat height 17" - 22"
	Mesh back (mid)	Grade 6 / Grade-in E	\$697.00	Travel range (ht.) 3" (back) / 5" (seat)
	Seat depth adjustment	LG1 (Evita) / C.O.L.	\$757.00	COM 1 yd.
	55mm multi-surface casters (STD)	LG2 (Lena- <b>LDEL, LLUT, LORC</b> only)*	\$772.00	Carton / FedEx wt 52 lbs / 101 lbs
		LG3 (Vulcano- <b>LMIT, LSTG</b> only)*	\$777.00	Arms Group 1 & 4
				Warranty 12 year limited

\*For NON In-Stock colors, check with OM Seating for additional pricing details.

Model	Description	Textile Grade-In	List	Specifications
<b>YS74</b> 	<i>Management Synchro (-1)</i>	Grade 1 / C.O.M.	\$636.00	Overall width 27"
	Pneumatic lift	Grade 2 / Grade-in A	\$651.00	Overall height 35.5" - 43.5"
	EZ back height adjustment	Grade 3 / Grade-in B	\$666.00	Back 19" w x 20" h
	<b>3-stage locking tilt</b>	Grade 4 / Grade-in C	\$681.00	Seat 20.5" w x 18-21.1" d
	Synchronous seat/back tilt	Grade 5 / Grade-in D	\$696.00	Seat height 17.5" - 22.5"
	Mesh back (mid)	Grade 6 / Grade-in E	\$711.00	Travel range (ht.) 3" (back) / 5" (seat)
	Seat depth adjustment	LG1 (Evita) / C.O.L.	\$771.00	COM 1 yd.
	Tension knob	LG2 (Lena- <b>LDEL, LLUT, LORC</b> only)*	\$786.00	Carton / FedEx wt 52 lbs / 101 lbs
	55mm multi-surface casters (STD)	LG3 (Vulcano- <b>LMIT, LSTG</b> only)*	\$791.00	Arms Group 1 & 4
				Warranty 12 year limited

\*For NON In-Stock colors, check with OM Seating for additional pricing details.

Model	Description	Textile Grade-In	List	Specifications
<b>YS84</b> 	<i>Full Multi-Function (-8b)</i>	Grade 1 / C.O.M.	\$711.00	Overall width 27"
	Pneumatic lift	Grade 2 / Grade-in A	\$726.00	Overall height 36" - 44"
	EZ back height adjustment	Grade 3 / Grade-in B	\$741.00	Back 19" w x 20" h
	Tilting backrest	Grade 4 / Grade-in C	\$756.00	Seat 21" w x 18-21.1" d
	Rocking tilt	Grade 5 / Grade-in D	\$771.00	Seat height 17" - 22"
	Tension knob	Grade 6 / Grade-in E	\$786.00	Travel range (ht.) 3" (back) / 5" (seat)
	Mesh back (mid)	LG1 (Evita) / C.O.L.	\$846.00	COM 1 yd.
	Seat depth adjustment	LG2 (Lena- <b>LDEL, LLUT, LORC</b> only)*	\$861.00	Carton / FedEx wt 54 lbs / 101 lbs
	Infinite forward tilting	LG3 (Vulcano- <b>LMIT, LSTG</b> only)*	\$866.00	Arms Group 1 & 4
	55mm multi-surface casters (STD)			Warranty 12 year limited

\*For NON In-Stock colors, check with OM Seating for additional pricing details.

high back / high back with headrest

Model	Description	Textile Grade-In	List	Specifications
<b>YS78</b> 	<i>Management Synchro (-1)</i>	Grade 1 / C.O.M.	\$675.00	Overall width 27"
	Pneumatic lift	Grade 2 / Grade-in A	\$690.00	Overall height 41.5" - 49.5"
	<b>3-stage locking tilt</b>	Grade 3 / Grade-in B	\$705.00	Back 20" w x 24" h
	NEW Aluminum base in matte black	Grade 4 / Grade-in C	\$720.00	Seat 20.5" w x 18-20" d
	Synchronous seat/back tilt	Grade 5 / Grade-in D	\$735.00	Seat height 17.5" - 22.5"
	Mesh back (high)	Grade 6 / Grade-in E	\$750.00	Travel range (ht.) 5" (seat)
	Seat depth adjustment	LG1 (Evita) / C.O.L.	\$810.00	COM 1 yd.
	55mm black universal soft casters	LG2 (Lena- <b>LDEL, LLUT, LORC</b> only)*	\$825.00	Carton / FedEx wt 53 lbs / 101 lbs
	Tension knob	LG3 (Vulcano- <b>LMIT, LSTG</b> only)*	\$830.00	Arms Group 1 & 4
				Warranty 12 year limited

\*For NON In-Stock colors, check with OM Seating for additional pricing details.

Above weights do not include optional arm kits ; FedEx weight is calculated using FedEx dimensional standards to determine billable weight. ; Pricing and specifications subject to change without notification.

# Yes Series (YS)

Conference | Boardroom | Executive

Please see pages 176, 189 – 207 for arm kits, casters, and other options.

high back / high back with headrest

Model	Description	Textile Grade-In	List	Specifications
<b>YS79</b> 	<i>Management Synchro (-1)</i>	Grade 1 / C.O.M.	\$797.00	Overall width 27"
	Pneumatic lift	Grade 2 / Grade-in A	\$812.00	Overall height 46" - 55"
	3-stage locking tilt	Grade 3 / Grade-in B	\$827.00	Back 20" w x 24" h
	NEW Aluminum base in matte black	Grade 4 / Grade-in C	\$842.00	Seat 20.5" w x 18-20" d
	Synchronous seat/back tilt	Grade 5 / Grade-in D	\$857.00	Seat height 17.5" - 22.5"
	Mesh back (high)	Grade 6 / Grade-in E	\$872.00	Travel range (ht.) 5" (seat)
	Seat depth adjustment	LG1 (Evita) / C.O.L.	\$932.00	COM 1 yd.
	55mm black universal soft casters	LG2 (Lena- <b>LDEL, LLUT, LORC</b> only)*	\$947.00	Carton / FedEx wt 63 lbs / 101 lbs
	Tension knob	LG3 (Vulcano- <b>LMIT, LSTG</b> only)*	\$952.00	Arms Group 1 & 4
	Adjustable headrest*			Warranty 12 year limited
			*For NON In-Stock colors, check with OM Seating for additional pricing details.	

Model	Description	Textile Grade-In	List	Specifications
<b>YS88</b> 	<i>Full Multi-Function (-8b)</i>	Grade 1 / C.O.M.	\$750.00	Overall width 27"
	Pneumatic lift	Grade 2 / Grade-in A	\$765.00	Overall height 40" - 48"
	EZ back height adjustment	Grade 3 / Grade-in B	\$780.00	Back 19" w x 24" h
	Tilting backrest	Grade 4 / Grade-in C	\$795.00	Seat 21" w x 18-21.1" d
	Rocking tilt	Grade 5 / Grade-in D	\$810.00	Seat height 17 - 22"
	Tension knob	Grade 6 / Grade-in E	\$825.00	Travel range (ht.) 3" (back) / 5" (seat)
	Mesh back (high)	LG1 (Evita) / C.O.L.	\$885.00	COM 1 yd.
	Seat depth adjustment	LG2 (Lena- <b>LDEL, LLUT, LORC</b> only)*	\$900.00	Carton / FedEx wt 55 lbs / 101 lbs
	Infinite forward tilting	LG3 (Vulcano- <b>LMIT, LSTG</b> only)*	\$905.00	Arms Group 1 & 4
	55mm multi-surface casters (STD)			Warranty 12 year limited
			*For NON In-Stock colors, check with OM Seating for additional pricing details.	

Model	Description	Textile Grade-In	List	Specifications
<b>YS89</b> 	<i>Full Multi-Function (-8b)</i>	Grade 1 / C.O.M.	\$872.00	Overall width 27"
	Pneumatic lift	Grade 2 / Grade-in A	\$887.00	Overall height 44.5" - 54"
	EZ back height adjustment	Grade 3 / Grade-in B	\$902.00	Back 19" w x 24" h
	Tilting backrest	Grade 4 / Grade-in C	\$917.00	Seat 21" w x 18-21.1" d
	Rocking tilt	Grade 5 / Grade-in D	\$932.00	Seat height 17" - 22"
	Tension knob	Grade 6 / Grade-in E	\$947.00	Travel range (ht.) 3" (back) / 5" (seat)
	Mesh back (high)	LG1 (Evita) / C.O.L.	\$1,007.00	COM 1 yd.
	Seat depth adjustment	LG2 (Lena- <b>LDEL, LLUT, LORC</b> only)*	\$1,022.00	Carton / FedEx wt 58 lbs / 101 lbs
	Adjustable headrest*	LG3 (Vulcano- <b>LMIT, LSTG</b> only)*	\$1,027.00	Arms Group 1 & 4
	Infinite forward tilting			Warranty 12 year limited
	55mm multi-surface casters (STD)			
		*For NON In-Stock colors, check with OM Seating for additional pricing details.		

Model	Description	Textile Grade-In	List	Specifications
<b>YS98</b> 	<i>Management Synchro (-1)</i>	Grade 1 / C.O.M.	\$696.00	Overall width 27"
	Pneumatic lift	Grade 2 / Grade-in A	\$711.00	Overall height 40" - 48"
	EZ back height adjustment	Grade 3 / Grade-in B	\$726.00	Back 19" w x 24" h
	<b>3-stage locking tilt</b>	Grade 4 / Grade-in C	\$741.00	Seat 21" w x 18-21.1" d
	NEW Aluminum base in matte black	Grade 5 / Grade-in D	\$756.00	Seat height 17" - 22"
	Synchronous seat/back tilt	Grade 6 / Grade-in E	\$771.00	Travel range (ht.) 3" (back) / 5" (seat)
	Mesh back (high)	LG1 (Evita) / C.O.L.	\$831.00	COM 1 yd.
	Seat depth adjustment	LG2 (Lena- <b>LDEL, LLUT, LORC</b> only)*	\$846.00	Carton / FedEx wt 58 lbs / 101 lbs
	55mm black universal soft casters	LG3 (Vulcano- <b>LMIT, LSTG</b> only)*	\$851.00	Arms Group 1 & 4
	Tension knob			Warranty 12 year limited
			*For NON In-Stock colors, check with OM Seating for additional pricing details.	

**\*YES SERIES HEADREST NOTES:**

- YS79 and YS89 are upholstered (by default unless otherwise specified) with a black, leather-like material such as G3 Cinema.
- Optional mesh (unupholstered) headrest option HR-YSM - Subtract \$44 from list.

Above weights do not include optional arm kits. ; FedEx weight is calculated using FedEx dimensional standards to determine billable weight. ; Pricing and specifications subject to change without notification.

# Yes Series (YS)

Conference | Boardroom | Executive

Please see pages 176, 189 – 207 for arm kits, casters, and other options.

stools

Model	Description	Textile Grade-In	List	Specifications
<b>YS73</b> 	<i>Simple Multi-Function (-7aCLS)</i>	Grade 1 / C.O.M.	\$677.00	Overall width 27"
	Pneumatic lift	Grade 2 / Grade-in A	\$692.00	Overall height 46" - 57"
	Infinitely locking back tilt	Grade 3 / Grade-in B	\$707.00	Back 19" w x 20" h
	EZ back height adjustment	Grade 4 / Grade-in C	\$722.00	Seat 20.5" w x 18-21.1" d
	Mesh back (mid)	Grade 5 / Grade-in D	\$737.00	Seat height 25" - 33"
	Seat depth adjustment	Grade 6 / Grade-in E	\$752.00	Travel range (ht.) 3" (back) / 8" (seat)
	Grande Spider Package	LG1 (Evita) / C.O.L.	\$812.00	COM 1 yd.
	Dual-tone universal soft casters	LG2 (Lena- <b>LDEL, LLUT, LORC</b> only)*	\$827.00	Carton / FedEx wt 56 lbs / 101 lbs
		LG3 (Vulcano- <b>LMIT, LSTG</b> only)*	\$832.00	Arms Group 1 & 4
				Warranty 12 year limited

\*For NON In-Stock colors, check with OM Seating for additional pricing details.

Model	Description	Textile Grade-In	List	Specifications
<b>YS75</b> 	<i>Simple Multi-Function (-7aCLS)</i>	Grade 1 / C.O.M.	\$795.00	Overall width 27"
	Pneumatic lift	Grade 2 / Grade-in A	\$810.00	Overall height 43" - 57"
	EZ back height adjustment	Grade 3 / Grade-in B	\$825.00	Back 19" w x 20" h
	Infinitely locking back tilt	Grade 4 / Grade-in C	\$840.00	Seat 20.5" w x 18-21.1" d
	NEW Aluminum base in matte black	Grade 5 / Grade-in D	\$855.00	Seat height 26" - 36"
	Mesh back (mid)	Grade 6 / Grade-in E	\$870.00	Travel range (ht.) 3" (back) / 10" (seat)
	Seat depth adjustment	LG1 (Evita) / C.O.L.	\$930.00	COM 1 yd.
	Turn-lock footring	LG2 (Lena- <b>LDEL, LLUT, LORC</b> only)*	\$945.00	Carton / FedEx wt 58 lbs / 101 lbs
	55mm black universal soft casters	LG3 (Vulcano- <b>LMIT, LSTG</b> only)*	\$950.00	Arms Group 1 & 4
				Warranty 12 year limited

\*For NON In-Stock colors, check with OM Seating for additional pricing details.

large / xtra tall

Model	Description	Textile Grade-In	List	Specifications
<b>YSYM</b> 	<i>Full Multi-Function (-8b)</i>	Grade 1 / C.O.M.	\$1,310.00	Overall width 28"
	Pneumatic lift	Grade 2 / Grade-in A	\$1,325.00	Overall height 42" - 52"
	EZ back height adjustment	Grade 3 / Grade-in B	\$1,340.00	Back 19" w x 24" h
	Tilting backrest	Grade 4 / Grade-in C	\$1,355.00	Seat 23.5" w x 20.5-23.6" d
	Rocking tilt	Grade 5 / Grade-in D	\$1,370.00	Seat height 19" - 25"
	Tension knob	Grade 6 / Grade-in E	\$1,385.00	Travel range (ht.) 3" (back) / 6" (seat)
	Mesh back (high)	LG1 (Evita) / C.O.L.	\$1,470.00	COM 1 yd.
	Seat depth adjustment	LG2 (Lena- <b>LDEL, LLUT, LORC</b> only)*	\$1,485.00	Carton / FedEx wt 55 lbs / 195 lbs
	Forward tilting	LG3 (Vulcano- <b>LMIT, LSTG</b> only)*	\$1,495.00	Arms Group 1 & 4
	Dual-tone universal soft casters			Warranty 12 year limited

\*For NON In-Stock colors, check with OM Seating for additional pricing details.

Above weights do not include optional arm kits. ; FedEx weight is calculated using FedEx dimensional standards to determine billable weight. ; Pricing and specifications subject to change without notification.





# Yes Series (YS)

Conference | Boardroom | Executive

Please see pages 176, 189 – 207 for arm kits, casters, and other options.



side and nesting chairs

Model	Description	Textile Grade-In	List	Specifications
<b>YS70N</b> 	Convenient nesting chair design	Grade 1 / C.O.M.	\$478.00	Overall width 24"
	Mesh back	Grade 2 / Grade-in A	\$493.00	Overall height 37" (fixed)
	Fixed arms standard	Grade 3 / Grade-in B	\$508.00	Back 20" w x 20" h
	Black Powdercoat frame (standard)	Grade 4 / Grade-in C	\$523.00	Seat 18.5" w x 18.5" d
	Silver Powdercoat frame (option)	Grade 5 / Grade-in D	\$538.00	Seat height 18" (fixed)
		Grade 6 / Grade-in E	\$553.00	COM 1 yd.
		LG1 (Evita) / C.O.L.	\$613.00	Carton weight 38 pounds
		LG2 (Lena-LDEL, LLUT, LORC only)*	\$628.00	FedEx weight 85 pounds
		LG3 (Vulcano-LMIT, LSTG only)*	\$633.00	Arms Included
				Warranty 12 year limited



 No upcharge for Silver frame option  
 Add -SLR after model #  
 Ships with back detached.

\*For NON In-Stock colors, check with OM Seating for additional pricing details.

Model	Description	Textile Grade-In	List	Specifications
<b>YS71N</b> 	Convenient nesting chair design	Grade 1 / C.O.M.	\$471.00	Overall width 22.5"
	Mesh back	Grade 2 / Grade-in A	\$486.00	Overall height 37" (fixed)
	Armless	Grade 3 / Grade-in B	\$501.00	Back 20" w x 20" h
	Black Powdercoat frame (standard)	Grade 4 / Grade-in C	\$516.00	Seat 18.5" w x 18.5" d
	Silver Powdercoat frame (option)	Grade 5 / Grade-in D	\$531.00	Seat height 18" (fixed)
		Grade 6 / Grade-in E	\$546.00	COM 1 yd.
		LG1 (Evita) / C.O.L.	\$606.00	Carton weight 37 pounds
		LG2 (Lena-LDEL, LLUT, LORC only)*	\$621.00	FedEx weight 85 pounds
		LG3 (Vulcano-LMIT, LSTG only)*	\$626.00	Arms none
				Warranty 12 year limited



 No upcharge for Silver frame option  
 Add -SLR after model #  
 Ships with back detached.

\*For NON In-Stock colors, check with OM Seating for additional pricing details.

Model	Description	Textile Grade-In	List	Specifications
<b>YS71S</b> 	Mesh back (mid)	Grade 1 / C.O.M.	\$371.00	Overall width 21"
	Cantilever sled base	Grade 2 / Grade-in A	\$386.00	Overall height 39.5" (fixed)
	Optional arms available	Grade 3 / Grade-in B	\$401.00	Back 19" w x 20" h
		Grade 4 / Grade-in C	\$416.00	Seat 20.5" w x 18" d
		Grade 5 / Grade-in D	\$431.00	Seat height 19" (fixed)
		Grade 6 / Grade-in E	\$446.00	COM 1 yd.
		LG1 (Evita) / C.O.L.	\$506.00	Carton weight 41 pounds
		LG2 (Lena-LDEL, LLUT, LORC only)*	\$521.00	FedEx weight 62 pounds
		LG3 (Vulcano-LMIT, LSTG only)*	\$526.00	Arms Group 1 & 4
				Warranty 12 year limited

Ships with back detached.

\*For NON In-Stock colors, check with OM Seating for additional pricing details.

Model	Description	Textile Grade-In	List	Specifications
<b>YS76S</b> 	Mesh back (high)	Grade 1 / C.O.M.	\$415.00	Overall width 21"
	Cantilever sled base	Grade 2 / Grade-in A	\$430.00	Overall height 41.5" (fixed)
	Optional arms available	Grade 3 / Grade-in B	\$445.00	Back 20" w x 24" h
		Grade 4 / Grade-in C	\$460.00	Seat 20.5" w x 18" d
		Grade 5 / Grade-in D	\$475.00	Seat height 18.5" (fixed)
		Grade 6 / Grade-in E	\$490.00	COM 1 yd.
		LG1 (Evita) / C.O.L.	\$550.00	Carton weight 41 pounds
		LG2 (Lena-LDEL, LLUT, LORC only)*	\$565.00	FedEx weight 100 pounds
		LG3 (Vulcano-LMIT, LSTG only)*	\$570.00	Arms Group 1 & 4
				Warranty 12 year limited

\*For NON In-Stock colors, check with OM Seating for additional pricing details.

Above weights do not include optional arm kits. ; FedEx weight is calculated using FedEx dimensional standards to determine billable weight. ; Pricing and specifications subject to change without notification.







# Yes Series (YS)

Conference | Boardroom | Executive

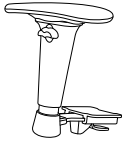
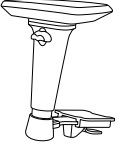
Please see pages 189 – 207 for some relevant options.

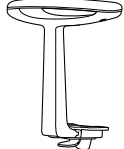
common options

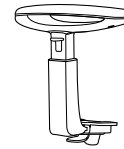
## Common Options for Yes Series

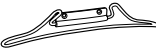
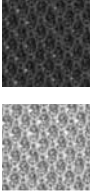
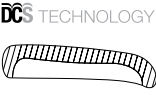
<p><b>Arms</b></p>  <p><b>JR39 (2D Motion)</b> - list: 132.00 Height and width adjustable forward slanting T-arms with soft touch width adjustment trigger.</p> <p>For specs. and warranty, see page 193.</p>	 <p><b>JR49 (4D Motion)</b> - list: 196.00 Height and width adjustable, forward slanting T-arms with soft touch width adjustment trigger, fore-aft, side-side and inward pivoting arm top (RP-45).</p> <p>For specs. and warranty, see page 194.</p>
 <p><b>KR100-50 (4D+ Motion)</b> (formerly KR540) - list: 205.00 Height and width adjustable, removable T-arms with 6-way ultra adjustable, omni directional arms top (RP-50).</p> <p>For specs. and warranty, see page 196.</p>	 <p><b>AR81 (1D Motion)</b> - list: 205.00 Width adjustable, fixed height polished aluminum loop top arm.</p> <p>For specs. and warranty, see page 191.</p>
 <p><b>KR100-65 (4D Motion)</b> (formerly KR465) - list: 195.00 Height and width adjustable, removable T-arms with lockable arm top, fore-aft, side-side, pivoting arm top (RP-65).</p> <p>For specs. and warranty, see page 195.</p>	 <p><b>AR485 (3D Motion)</b> - list: 349.00 Height and width adjustable polished aluminum loop top arms with pivoting motion.</p> <p>For specs. and warranty, see page 194.</p>
<p><b>Options</b></p>  <p><b>HRD (Deluxe 3D Headrest)</b> - list: 138.00 3-way adjustable headrest with 2 pivot points, and an upholstered head/neck-rest pad that slides to accommodate different height users.</p> <p>Note: Available on high back models only. Coat rack and Headrest combination available with this headrest only. Default in Grade 3 leather-like material.</p>	 <p><b>CTR (Coat Rack)</b> - list: 105.00 Black powdercoated, wire road coat hanger with collar support. Available on Yes series (high-back models only).</p> <p>Note: Coat Rack and Headrest combination available with Deluxe 3D Headrest only.</p>
 <p><b>“Neighborhood Collection” Backrest Upholstery</b> - list: 68.00 A breathable, knit overlay with 9 lively color choices. Please refer to the OM5 + Affirm Backrest Upholstery card.</p> <p>Note: Neighborhood Collection fabric is not suitable for seat fabrics</p>	 <p><b>DCS TECHNOLOGY DCSZA</b> - list: 98.00 OM's unique double molded memory foam seat. Designed for maximum comfort and long-lasting durability.</p> <p>Note: Must be specified when ordering.</p>

Above weights do not include optional arm kits. ; FedEx weight is calculated using FedEx dimensional standards to determine billable weight. ; Pricing and specifications subject to change without notification.

# OM company information



## Features:

About OM

OM Terms & conditions

Warranty

GSA Terms & conditions

“Sustainable environmentalism”

BIFMA Test for fit



# About OM

---

## **The Company**

OM is known for excellence in function. With a single focus on seating, and only seating, OM offers a broad and deep understanding of what makes a chair work. Whatever the environment, and whatever the purpose, an OM chair will suit your needs. By focusing exclusively on ergonomic and well-thought-out seating, OM is able to offer a range of choices that are both situation-appropriate and value-oriented. With a myriad of adjustments, ranges of scale, and abundant design features, OM chairs perform. From the innovative and exclusive “body activated motion” to the more traditional option of multiple independent adjustments, an OM chair responds to your needs for dynamic motion, support, and comfort. Since 1986 OM has been building reliable, high quality, ergonomic seating – and has striven to uphold our reputation as the source for smart seating.

## **Local Needs, Global Sourcing**

OM never compromises on quality; whether in its seating, representatives, suppliers, or components. Through successful, long-established global sourcing relationships OM has developed tight-knit vendor-manufacturer partnerships that allow it to incorporate better quality components at a more cost-effective price, thereby creating high value for everyone.

## **Lead Times, Delivery & Distribution**

OM seating is made-to-order and available for shipping from Ontario, California with normal lead-times of around 7-10 working days. OM’s portfolio of end-users includes nationwide- seating standards for many large to small corporate, healthcare, education, institutional and other customers. OM’s seating products are available for national distribution and installation through customers’ respective servicing dealer networks of choice. OM’s authorized dealer distribution strategy affords users the choices they need to source better, more flexible dealer services to meet their specific needs. OM dealers comprise a broad network of supply chain contract furniture dealers, stationary supply chains, medical supply & ergonomic specialty dealers. To find out if a specific dealer is an authorized OM partner, please contact OM toll-free at 877.766.5678.

## **Production Capabilities**

OM routinely leverages its strong supplier relationships, seating design expertise, and quick turnaround capabilities to customize solutions for specific customer needs. As a committed partner/ manufacturer for multiple national accounts, OM has developed a strong reputation for its ability to meet customer requirements with purpose-appropriate and value-oriented seating solutions.

## **Upholstery Options**

OM offers thousands of in-stock and grade-in fabrics, special health-care-oriented polyurethanes, vinyls, cryptons, TB-133, premium leather, and ESD options. We offer a broad range of selections with graded-in pricing from such partners as Designtex, Momentum Textiles, Mayer Fabrics, C.F. Stinson, and more. OM also offers a variety of environmentally-friendly upholstery options from both its in-stock, and graded-in choices. Production lead times on all graded-in upholstery and customer-owned materials may vary based on receipt of all material(s).

## **Warranty**

OM chair parts are warranted for lifetime, 12- and 7-year periods (varies by series). Every chair carries a “born-on” production label showing all pertinent information to support follow-up warranty claims. To view a full warranty, please contact OM or turn to page 180 of this price book.

## **Product Selection**

OM offers a broad selection of seating, arms, and other options for a wide array of uses including Ergonomic, Corporate Standards, Medical/Healthcare, Schools, Production, Labs, ESD, Conference, Stacker, Lunchroom, 24-Hour-Use or Call Centers, and Big/Tall. For example, numerous options and styles are available to address all aspects of Healthcare requirements; included are models suited for Nurses’ stations, Exam rooms, Doctors’ Offices, Labs, Counter Height, Administration, Conference, Side chairs, Workstools, Waiting Rooms, Inventory & Executive Ergonomic.

# Terms & Conditions

These terms and conditions apply to authorized OM dealers.

For additional company or product information, visit us at our online home: [omseating.com](http://omseating.com)

**Prices** Published prices and specifications are approximate and are subject to change without notice. All prices shown in this book are shown at List and F.O.B. OM unless otherwise noted. Prices do not include delivery charges, installations, special handling or any applicable sales, use, excise or other similar taxes. For example, California tax laws require that in cases where an order originates from a dealer outside of CA, but ships to a destination within the state, OM must collect an appropriate sales or use tax. If a customer claims exemption from such taxes, an exemption or CA resale certificate must be furnished to OM upon or before placement of the order.

**Terms** Terms are net 30 days (on approved credit only) from the date of invoice issuance. A late payment finance charge of 1.5% per month (18% annual percentage rate) will be assessed on all open invoices not paid within terms. Paying within terms will preserve your competitive pricing schedule and payment terms. A processing fee of 3% may be charged for payments made via credit card. OM can accept Visa, Mastercard and AMEX.

**Customer's own Material (C.O.M.)** If a customer desires to use a fabric or leather not supplied by OM, it is considered C.O.M. or C.O.L. Refer to the C.O.M. specifications section in this price book (p. 186) for detailed information on the use of such materials. Any C.O.M. and/or C.O.L. rolls, samples, hides, etc. that are being sent to OM for application testing or use on an order should be delivered to:

## OM Seating

C/O - C.O.M. and Fabrics Dept  
1110 South Mildred Avenue  
Ontario, CA 91761

A shipping date will not be scheduled until all the C.O.M./C.O.L. materials for an order are received completely by OM. Any request for the return of unused fabrics must be made clearly on the Purchase Order and with specific instructions. Return freight and a handling fee will be charged. Customers should ask their fabrics vendors to side-mark all shipping labels for material(s) sent to OM with their company names, fabric colors & patterns, and the purchase order number(s) used with their order at OM.

**Changes and Cancellations** All changes and cancellations will be subject to approval by OM and must be requested within 24 hours after OM receives the order. Changes and cancellations may only be approved for orders that have not entered any stage of production. A minimum of 25% change order fee, but can be more, will apply to any changed orders. Cancellations, if approved, are subject to a penalty up to the entire amount of the order. Because we make our chairs to order and make every effort to ship as quickly as possible, we strongly discourage making any changes or amendments to your purchase orders whenever possible.

**Returns** Returns will not be accepted without an accompanying, written Return Merchandise Authorization Number (RMA). Please contact customer service to obtain an RMA. Returns must be received within 30 calendar days from the date of RMA# issuance. Authorized returned merchandise shall only be delivered to OM on prepaid freight. OM reserves the right to inspect all returned goods before issuing any appropriate credit. A minimum restocking fee of 25% applies to returned merchandise received in good resalable condition. C.O.M. orders may not be eligible for return.

**Warranty** The warranty period is listed with each model for the original purchaser only. Full warranty information can be found on the hangtag attached to each chair shipped, as well as on p. 180. OM's sales representatives or customer service will ship appropriate replacement parts when deemed reasonable. Labor, field service or delivery charges are not covered. Unless otherwise specified all OM products are manufactured in accordance with normal commercial usage - for a single 8-hour shift, a total of 40 hours or less per week, and by persons weighing 275 pounds or less. OM shall not be liable for loss or damage resulting from use beyond the approved range or by any cause beyond reasonable control such as abuse, misuse, neglect, alteration, or act of God. Special terms may apply on certain series; please see the relevant product page in this price book for details.

**Shipping** (see EZ Freight Program for more information) Most items can be shipped boxed and/or shipped via FedEx, except models marked with 'non-FedExable' in this price book. In the absence of specific shipping instructions on purchase orders, OM will select the carrier and the method of shipment based on delivery area, freight cost and quality of service. All freight costs incurred by OM will be charged to the customer except when subsidized under the terms of the EZ Freight Program or other agreement with OM. Please notify the freight company directly in case of any shortage or damages and advise OM immediately of the damages incurred during shipping.

For items shipped in California, please specify the packing preference, whether "Product in Box" or "Assembled" on all purchase orders. There is a minimum charge for blanket-wrap delivery service. Not all areas in California can be shipped assembled or under normal shipping lead times. Please call OM for detailed information. Fully assembled chairs may be an option for other destinations as well, but usually require a full truckload quantity of at least 330 full scale task chairs to qualify. Additional charge(s) will likely apply. Contact OM for details, limitations and quote.

If you select your own carrier, please clearly state the carrier's name, phone number, your account# with them, the name of a contact person and any special shipping and freight billing instructions on your purchase order to OM.

In all cases—whether landed or FOB Factory discounting was applied—OM reserves the sole right to determine carriers and packaging/shipping methods (such as: chair count per carton, carton type/size, assembled vs. semi- or k.d. in a box). These decisions will be made with strong consideration for balancing best practices, cost-discipline, and known customer preference(s).

**Order Acknowledgement** An order acknowledgement will be faxed or emailed to you upon receipt and entry of your PO within 48 hours. Please review all order acknowledgement details for any items and/or pricing and/or quantity discrepancies, and notify the factory within 24 hours of any necessary revisions, or additions.

**Additional Charges and Notes** In cases where non-warranty re-work or other shop time is needed, a charge of \$45 per hour will apply for in-house labor and processing. OM reserves the right to charge a \$25 storage fee per business day for any orders that have not been picked up after 3 pickup readiness notifications by OM or 7 business days. All fees mentioned in this section are NET and are not subject to any other discounts. If a Credit Card is used for payment, relevant fees will apply.

# Limited Warranty

---

Office Master, Inc. (OM Seating) warrants to the original purchaser that its products are free from defects in materials and workmanship for the applicable warranty period, as indicated below.

Should any item fail, OM Seating will – at its sole discretion – repair or replace, with a comparable product or part, any item found to be defective as a result of normal commercial use (i.e., a single 8-hour shift, 5 days per week).

This warranty does not apply to items subjected to abuse, misuse, neglect, alteration, or damage caused by shipment, storage, accident, fire, flood, or act of God.

## **Lifetime Limited Warranty**

The OM5 Series® (including the OM5 Active sub-series), Truly,\* Series, and Ginny are covered by a lifetime limited warranty on all structural components as defined below.

## **12-year Limited Warranty**

Unless otherwise specified, all models not classified as budget or 24/7 or heavy-duty are covered under a 12-year limited warranty on all structural components as defined below.

## **7-year Limited Warranty**

Unless otherwise specified, all models classified as budget or 24/7 or heavy-duty or bariatric are covered under a 7-year limited warranty on all structural components as defined below. Budget series include: BC, SG, ST, and WS. Bariatric series includes: GY4B-26 and GY4B-30.

## **Warranty Terms**

Within a given model's applicable warranty period, all structural components, including gas cylinders, wood, metal and plastic parts (i.e., chair frames, bases and control handles) are guaranteed against structural failure when under normal commercial use. All OM seating comes with a default 275 lbs. weight capacity limit unless otherwise specified by OM Seating.

For all models, consumable items (i.e., casters, glides, etc.) are covered by a 5-year normal commercial use warranty with the exception of Rubber Casters which will be a 1-Year Limited Warranty.

## **Fabrics and Foam**

OM Seating in-stock upholstery & foam cushions are covered by a 5-year normal commercial use warranty. Normal wear and tear on fabrics such as wrinkling, dirt accumulation or gathering is not covered. This includes Truly,\* Series "Jackets" and "Wraps". Natural, minor variations may exist in color, surface, grain or texture of upholstery materials. As a result, any such variations are not warranted. COM/COL and graded-in fabrics are not covered.

## **Claims Procedure**

Should any item fail, contact the Dealer from whom it was purchased. A photograph of the damage(s)/issue(s) and of the "born-on" label underneath the seat will be required to help OM determine the cause and extent of any issues. If it is determined that a return is necessary, return that item and its product proof of purchase to the Dealer, whereupon that Dealer will send both to OM Seating, freight prepaid. OM will repair or replace the defective part at its sole discretion and return it to the Dealer, freight prepaid.

**Please email related photos and details for any warranty claims to [warranty@omseating.com](mailto:warranty@omseating.com).**

For claims to be approved and covered, please inspect for any damages or missing items within 10 days after receiving the order.

## **Returns**

Written authorization from OM Seating is required prior to a Dealer returning any failed or defective parts to OM Seating. Any returned defective part(s) will NOT be accepted without this prior written authorization, or a "Returned Materials Authorization" (RMA) # assigned to it.

## **Warranty Labor**

This warranty exclusively covers the repair or replacement of OM Seating parts as determined by OM Seating and does NOT cover any portion of field labor or service. For information regarding OM Seating's non-warranty shop time and related charges, please reference a current copy of OM Seating's pricebook, in the Terms and Conditions section.

**GSA-Contract No. GS-28F-0007W**  
**C.A.G.E Code 3HYL1; Fed ID# 33-0151691**  
**Schedule MAS 33721**  
**Contract Period: 10/26/2024 - 10/25/2029**  
**\*minority business enterprise and small business**  
**Office Master, Inc.**  
**1110 South Mildred Avenue, Ontario, CA 91761**  
**877.776.5678**  
**omseating.com/company/federal-contracts**

- 1a. **Special Item Numbers (SIN)** 33721 Office Furniture
- 1b. **Lowest Priced Model Number** SIN # 33721 Office Furniture, SG300 \$102.24
- 1c. **Contractor Hourly Rate** Not Applicable
- 2. **Maximum Order Limitation** \$500,000 Net
- 3. **Minimum Order Limitation** \$100 Net
- 4. **Geographic Coverage** 48 Continental United States & Washington D.C.
- 5. **Point of Production** Ontario, CA 91761
- 6. **Prices shown herein are Net, discount deducted, Delivered Price. Basic Discount is 52% off October 2023 • 1<sup>st</sup> Edition, Commercial Price List\*\***
- 7. **Quantity Discounts** Not Applicable
- 8. **Prompt Payment Terms** Net 30 Days
- 9. **Foreign Items** None
- 10a. **Time of Delivery** 2 weeks After Receipt of Order
- 10b. **Expedited Service** Contact Factory (case by case)
- 10c. **Overnight and 2-Day Delivery** Contact Factory
- 10d. **Urgent Requirements** Contact Factory (case by case)
- 11. **F.O.B. Point** Destination within 48 Contiguous States and Washington D.C.
- 12a. **Ordering Address** OM Seating 1110 South Mildred Avenue Ontario, CA 91761 P: 877-776-5678; 909-392-5678 F: 909-392-4567
- 12b. **Ordering Procedure** Contact Factory. \*Authorized Dealer should be noted on order
- 13. **Payment Address** Same As Above
- 14. **Warranty** Standard Commercial Warranty found on Pg. 180 of price book
- 15. **Export Packing Charges** Contact Factory
- 16. **Terms and Conditions of rental, maintenance, and repair** Not Applicable
- 17. **Terms and Conditions of Installation** Not Applicable
- 18a. **Terms and Conditions of repair parts indicating date of parts price lists and any discounts from list prices** Not Applicable
- 18b. **Terms and Conditions for any other services** Not Applicable
- 19. **List of Service and distribution points** Not Applicable
- 20. **List of Participating Dealers** Contact OM
- 21. **Preventive Maintenance** Not Applicable
- 22a. **Special Attributes** GREENGUARD Gold Certified, Small Business, BIFMA LEVEL® 2 Certified
- 22b. **Section 508 Compliance** Not Applicable
- 23. **Unique Entity Identified (UEI)** XN8EEM4RJK65
- 24. **OM Seating is registered with SAM.gov**

\*\* GSA Pricing continues to be based off **October 2023 • 1<sup>st</sup> Edition, Commercial Price List** at the time of this printing, and until further notice. Always check with OM or an authorized representative on which version/generation of our pricer is the most current basis for correct GSA pricing.

# OM Environmental

## Sustainable Environmentalism

**The people at OM believe in doing true and everlasting good. We believe that when we promote responsible new practices that build upon the organization's existing good habits, we can not only strengthen our products and the company but just as importantly, meaningfully minimize any negative impact we might have on our surrounding environment.**

**To this end, we've established at OM a culture of pursuing "Sustainable Environmentalism" – environmentalism that brings into harmony the enterprise's economic and environmental responsibilities.**

**By making the pursuit of environmental conservation align naturally with the undeniable corporate maxim of economic viability we manage to make OM a more responsible corporate citizen not just for isolated press releases, but day-in and day-out. Now that's taking a meaningful stand and making a positive difference for our future generations.**

**Here are some of the ways that we at OM are as smart about environmentalism as we are about our seating:**

### Building a Green Home

OM has built and is operating out of a new home that meets our twin goals of high efficiency and environmental friendliness. We began by exceeding CA's tough Title 24 energy consumption standards by an average of over 15%, and took it even further by using green building materials throughout...

- High efficiency HVAC units that utilize green refrigerants, zone dampers and energy saving economizers
- LEED-inspired building materials and lighting (CFL bulbs, recycled material in...carpets, corian countertops, office insulation, door cores, etc.)
- Dual-flush, low-flow and sensor-controlled valves on toilets, urinals and sinks
- Daylight, timer- and motion-activated sensor lighting controls in all warehouse, office and production areas
- Green landscaping irrigation systems that utilize reclaimed waste water
- Green-energy equipment (electric-powered forklifts, pallet jacks, and people movers replacing older propane-driven units)

### Encouraging & Reinforcing "Good" Habits

Just as our parents taught us, good habits are important. And good "green" habits are even more important because of the universal impact that they have... we encourage our customers, vendors and employees to all participate in our Sustainable Environmentalism program by cooperating in the following ways:

- Focus on Blanket Wrap shipping programs that utilize no cardboard packaging and maximize the space usage inside a truck because efficiency here means fewer emissions and less truck fuel consumed
- OM receives ongoing recognition for its recycling efforts (winning the California EPA "WRAP" award in 2008, 2009, 2010, 2011, . . .)
- FSC-certified and Recycled content in ALL printed materials – brochures, pricers, business cards, envelopes, labels, etc., as well as in our seating seat and back boards.
- Minimize cardboard and wood-based packaging materials...
  - > We purchase foam industry scraps to keep them out of landfills a while longer and so that they can be reused to protect our chairs in transit
  - > We purchase collapsible steel cages and instruct our vendors to use them in transporting components to us so that we can save on excess waste associated with cardboard

- > We use high recycled content paper pulp trays and cardboard boxes in our packaging.

### Building Sustainability into our Products

To OM, sustainability in good product design not only means that our chairs are made to last, but also that our material selections need to be made with the environment in mind. No matter which way you look at it, not having to replace your chair every few years with even the greenest chair not only saves money but also the limited resources of our environment!

- GREENGUARD™ Gold Certification on OM product families
- Custom Molded Materials from our CFC-free foam cushions to our plastic components such as shells and casters mean less waste and in many cases better comfort as well.
- Recyclability is a key component of our product sustainability strategy:
  - > Polypropylene is used on many of our components from back shells to arm frames and can be given a second life as everything from washing machine parts to car fenders.
  - > Polyurethane used in creating our seat and back foams can be converted into carpet padding
  - > Aluminum used on our bases footings can eventually be part of your car, kitchen appliances or even golf clubs and power tools.
  - > Steel is a key structural component used on mechanisms to arm brackets, etc. and it has potential to be re-used in countless ways from buildings to bridges, trucks, tools, etc.
  - > Wood such as that used on our seat and back boards can be shredded into mulch and used for landscaping or allowed to decompose.
- 100% water-based glue from a patented Swiss formula means 0 emissions hazards and an earth-friendly adhesive that works for the chairs and the earth
- Tree-farm harvested seat- and back-woods that are also FSC and CARB-certified give our chairs a sustainable, but durable structural component that lasts
- In-stock and Grade-in fabric selections are a way for our customers to participate in our Sustainable Environmentalism effort... OM offers many in-stock options that feature either recycled or recyclable content as well as a very extensive range of green fabrics through our grade-in programs.
  - > Including multiple patterns with varying percentages of post-industrial and/or post-consumer recycled materials (such as most of our Grade 5 ComfortKnit patterns, which are made from Repreve™ yarns that are made from recycled plastic bottles).



PARTICIPANT

### BIFMA Compliant information:

BIFMA Compliant,® the commercial furniture industry's registry of standards-conforming products. All OM Seating products BIFMA Compliant®.



### BIFMA LEVEL®

Developed by BIFMA, LEVEL is a voluntary certification program in which third-party auditors measure a product and its producer against the ANSI/BIFMA e3 Furniture Sustainability Standard. The LEVEL program was created to provide the most comprehensive, unbiased and transparent means of evaluating and communicating the environmental and social impacts of commercial furniture products. The LEVEL mark demonstrates that the product, the manufacturing facility, and the company responsible for the product brand, have all met the requirements for certification.

All OM Seating products are BIFMA LEVEL® 2 Certified.

[Click here to view our Corporate Responsibility Report.](#)



# Ergonomics

## Guide to Ergonomic Features

**Ergonomic features** determine which chair will provide the “best fit” for an individual.

The features illustrated here will help you understand the functionality and unique benefits of OM seating.



**BODY-ACTIVATED MOTION** (self-weighting)  
Seat & back tilt rate/tension automatically adjusts to occupant weight.

**Positive Back Release** also known as PBR, this safety feature prevents a catapult-launching effect when the tilt lock lever is released. Tilting/rocking features can only be reactivated when body weight is applied on the backrest.



**PNEUMATIC LIFT**  
Adjusts overall height of the chair.



**PIVOT BACKREST**  
Pivots as the user moves.



**TRUFIT™ BACK DESIGN**  
Full-range ergonomix backrest (Truly® Series).



**BACK HEIGHT ADJUSTMENT**  
Allows correct position of lumbar support.



**TILTING BACKREST**  
Locks in an infinite number of positions.



**ADJUSTABLE LUMBAR**  
Provides customized lumbar support.



**SYNCHRONOUS SEAT & BACK TILT**  
Activates single-lever adjustment.



**SLIDING SEAT**  
Adjusts seat depth for a variety of users.



**TILTING SEAT**  
Tilts forward and back for posture.



**TENSION KNOB**  
Controls rate and ease of recline/tilt.



**SWIVEL/ROCKING TILT**  
Provides “rocking motion” in any direction.

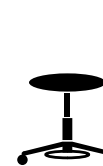

**HEEL/FOOT ACTIVATION RING\***  
Hands-free operation of pneumatic height.

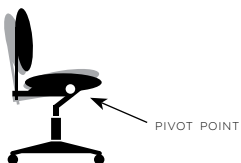

**SIMPLE KNEE TILT**  
Reduce some tension behind knees on tilt.

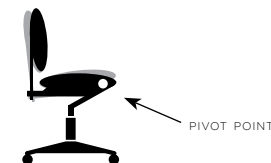

**FULL KNEE TILT**  
Reduce all tension behind knees on tilt.

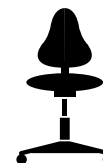

**DISCOVERY BACK DESIGN**  
Prevents scapular impedance.

\* available on CL14 and CL15 only

# Ultimate Test for Fit

BIFMA, UTFF, The Work Chair

---

## Ultimate Test For Fit (UTFF)

THE WORK CHAIR

### (7.1)

#### SEAT HEIGHT

Users should be able to sit with their feet comfortably on the floor or footrest without undue pressure on the underside of the thighs. The thigh-to-torso angle should not be less than 90°.

### (7.2)

#### SEAT DEPTH

Users should be able to sit in the chair without undue pressure against the back of the knees, their back properly supported by the backrest and with adequate buttock and thigh support.

### (7.3)

#### SEAT WIDTH

The seat should be wider than the hip breadth of the user with allowance for movement and clothing. The seat width should not limit the ability to use the armrests comfortably.

### (7.4)

#### SEAT PAN ANGLE

This should allow users to support their feet on the floor or footrest. They should not cause the user's torso-to-thigh angle to be less than 90°. Forward seat pan angles should not cause users to shift excessive weight to their feet or experience the sensation of sliding out of the chair.

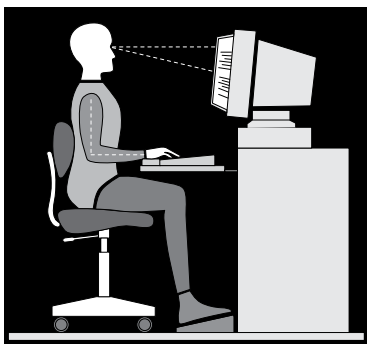

### (7.5)

#### BACK SUPPORT

##### (7.5.1)

##### SEAT BACKREST HEIGHT

All backrests should provide adequate lumbar support and buttocks clearance. For tasks requiring upper body mobility, the backrest should not interfere with the user's movement. For users who prefer reclining postures or greater upper back support, the back height should provide support for the shoulder blades.

##### (7.5.2)

##### BACKREST WIDTH

The width of the backrest should provide adequate support for the curvature of the user's back without causing localized pressure points.

##### (7.5.3)

##### LUMBAR SUPPORT

The height and shape of the lumbar support should coincide with the lumbar curve ("the small") of the user's back. The support should be firm, but not cause localized pressure points.

### (7.6)

#### MOVEMENTS OF THE SEAT PAN AND BACK SUPPORT

The user should be able to sit in a position where the torso-to-thigh angle is equal to or greater than 90°. The seat and backrest angles should accommodate the varying postures assumed by the user throughout the day.

### (7.7)

#### ARM SUPPORT

##### (7.7.1)

##### ARMREST HEIGHT

This should allow users to sit in a variety of postures while supporting their forearms and/or elbows in a manner that avoids lifting the shoulders (armrests too high) or leaning to the side to reach the armrest (armrests too low). The armrest height should allow accessibility to, and performance of, tasks.

##### (7.7.2)

##### ARMREST LENGTH

The length of the armrest should allow users to sit close enough to the work surface to perform their tasks while maintaining contact with the backrest.

##### (7.7.3)

##### INSIDE DISTANCE BETWEEN ARMRESTS

Armrests should allow users to sit in a variety of postures while supporting their forearms in a manner that avoids lifting the shoulders and/or excessive outward positioning of the elbows. Armrests should allow accessibility to, and performance of, tasks. The inside distance between the armrests should allow the user to enter and exit the chair easily. The hips should comfortably fit between the armrests or supports.

# COM, COL & Grade in Fabrics



## Features:

Specification form

Guidelines



# COM, COL & Grade-in

## Specifications

**Why read this form?** This form describes OM's standard procedures for COM, COL and Grade-In's fabrics and leathers. Reading it will help you understand how your materials will be dealt with, and how to avoid potential misunderstandings and delays with your order.

**Why fill out this form?** Fabric designs often come in intricate patterns. Different people may interpret the same fabric's direction in different ways. In order to avoid any confusion and to ensure that your order comes out the way you want, please use this form with your original PO to specify orientation.

**How much yardage should I send?** Yardage per chair is estimated in this price list and based upon 54" wide, plain or non-directional material.

Additional yardage may be required if striped or patterned material is used, if pattern requires matching or if width of material is less than 54" wide. Please call us at (877) 776 5678 if you have questions.

**Processing time** Orders for production of COM, COL and Grade-In's upholstered products are not scheduled for processing until upholstery material is received. OM will not ship orders until 7-10 business days after receipt of fabric(s) and/or material(s). No CBD or credit hold terms.

**Split orders** If a portion of your shipment does not require COM, please specify whether OM should ship complete or split. By default, OM puts orders on hold until all material is received. Please contact us if you need to split orders. Split shipments may incur additional charges or fees.

**Canceled or changed orders** Customers are responsible for the cost of the chair and any additional penalties as well as for arranging the return of any extra COM, COL or Grade-In's resulting from changes in upholstery material or cancellation of an order within 24 hour notice and minimum of 25% of change or cancellation fee. OM assumes no responsibility for this material.

**Excess upholstery material** OM will dispose of all excess upholstery material unless the customer specifically arranges otherwise.

**Upholstery material discrepancy** OM assumes no responsibility for defects in, or performance of, COM/COL. But if we detect any flaws with the upholstery material that we receive, we will immediately notify the customer by fax or by phone. In such a case, OM will hold the order until the customer advises us on what to do next. OM is not responsible for any delays on orders in which customer instructions are pending.

### OM Material Guideline Highlights

#### COM / GRADE-IN

- Unless otherwise stated, OM will exercise its discretion in choosing fabric direction (usual default as illustrated in Diagram 1, below).\*
- COM must be provided as continuous yardage, and is based upon 54" wide plain or non-directional material.
- Do not fold materials. OM is not responsible for material that is

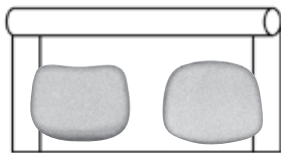

Diagram 1: Up the roll, off the roll.



Diagram 2

### COM specifications form

A copy of this form should accompany POs for orders with directional or intricate fabric designs. Please fill out completely.

Your name and company or id

Purchase order number

Phone number

OM sales order number (optional)

If any material remains after completion of my order, please...

- Dispose of it for me (default).
- Return it to me (we will bill the freight).
- Please see my instructions below.

Check the box that indicates how your fabric should run

- Selvage top and bottom / railroad
- Selvage side and side / top-down



Complex pattern (see explanation/information below)

Seat



Back



damaged or wrinkled upon receipt.

#### COL

- Leather should be sent in rolls, do not fold. OM is not responsible for material that is damaged or wrinkled upon receipt.
- Outer edges of leather can not be calculated as square feet or yardage.

#### COM & COL

- To avoid delays, all materials sent to OM must include the PO number of your order with us, clearly marked or tagged on all material.
- All fabrics and leathers will be examined before cutting and OM is not responsible for material that is damaged upon receipt.

#### Complex Patterns

Positioning of intricate patterns or pattern repeats on seat and back default centered (as shown in Diagram 2, bottom left). Customers can use the boxes provided on the COM Specification Form to sketch how they want patterns to appear. Be advised that if your COM or Grade-In's fabric has stripes, you need to state in your PO whether a vertical (up/down) or horizontal (left/right) orientation is to be applied. Otherwise, OM will use its sole discretion. Large pattern repeats may require up to 25% additional yardage.

\* OM's default layout is "Top-Down" (aka, "Off-the-roll"). Guidance from mill's website may be referenced on a case-by-case basis.

# Grade-in Program

## Guide to OM Grade-in Program

### Obtaining Current Grade-in Pricing

(Grades will change periodically)



Look for this graphic at [omseating.com](http://omseating.com) (under Fabrics catalog/Grade-in Fabrics) to download most up-to-date Grade-in prices.

### Ordering Grade-in Fabric

To order OM seating with a specific, grade-in pattern, you must note the following clearly on your PO:

- 1 Fabric Mill Name (Momentum Textiles, Mayer Fabrics, C.F. Stinson, Designtex or Ultrafabrics)
- 2 Grade-In x (where 'x' is the appropriate grade)
- 3 Your selected "Pattern Name" and "Color Number/Name"
- 4 Layout instructions (see page 186)

If the above information is not clearly and completely noted, OM will assume your PO to be a COM order and will wait for your fabrics to arrive.

### Selecting Patterns

To choose a pattern, or to see which pricing grade (Grade-In A, B, C, etc.) your selected pattern(s) falls under, please consult the accompanying chart or go directly to the appropriate fabric mill's website. OM's approved patterns are listed on [omseating.com](http://omseating.com) in the Fabric Catalog section.

Upon selecting a pattern, please note the grade selection noted to the right (see instruction 1 above).

### Grade-in Samples

In order to obtain any samples, please contact the appropriate fabric mill directly via its website or phone number.

Momentum Textiles ([www.themomgroup.com](http://www.themomgroup.com), 800 366 6839)  
Mayer Fabrics ([www.mayerfabrics.com](http://www.mayerfabrics.com), 800 428 4415)  
CF Stinson ([www.cfstinson.com](http://www.cfstinson.com), 800 841 6279)  
Designtex ([www.designtex.com](http://www.designtex.com), 800 221 1540)  
Knoll Textiles ([www.knoll.com/shoptextiles](http://www.knoll.com/shoptextiles), 866 565 5858)  
Ultrafabrics ([www.ultrafabricsinc.com](http://www.ultrafabricsinc.com), 800 309 6648)

### Split Orders

If you would like the items of your order that are not part of the Grade-in program to ship on a separate timeframe than the Grade-in portion of your PO, please contact an OM Customer Service representative to confirm. In such a case, a higher shipping cost for the PO may be incurred.

### Lead Times

Normal OM lead times for items ordered under the Grade-in program will be measured from the date of the receipt of all fabrics specified for a PO.

Order changes requested 24 hours after the original submission to OM may result in a longer lead time.

Actual processing times are also subject to individual credit terms and assume that all accounts are in good standing.

### Warranty

No OM warranties are implied or given under the Grade-in program beyond the pertinent standard fabric mill's original warranty coverage.

### Change Orders and Cancellations

For orders that have entered any stage of the production process, OM can not accept change orders or cancellations.

All fabric order changes (either OM textile or Grade-in) must be received within 24 hours of the original PO submission. Fabric changes to orders after the initial 24 hour period may be assessed additional fees.

### Fabric Application Testing

Some Products are subject to Fabric Application Testing if the textile has not been tested and approved, please check with OM Seating. Products that may need testing include: Truly. Jacket/ Wrap, Tibidi Seat/Seat & Back, CE2, CE2-P, Werksy Full Upholstery, and Plot Twist.

If the material is from our Grade-in Partner (CF Stinson, Designtex, Mayer, Momentum, Knoll, Ultrafabrics), OM will order the fabric for you. Otherwise, please fill out the form on the following page for each product and textile that needs to be tested.

# Fabric Application Testing Form

## Dealer and Project Information

DEALER NAME	PROJECT NAME
PROJECT NUMBER	PO# (IF APPLICABLE)

## Fabric Information

FABRIC NAME	TOP DOWN OR RAILROAD
-------------	----------------------

**TOP DOWN  
EXAMPLE**



**RAILROAD  
EXAMPLE**

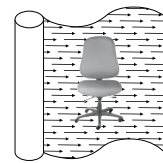

## Product(s) to be tested on

For pattern repeat larger than 7"V x 7"H check with OM Seating for yardage requirement.

- |  |  |   |
|--|--|---|
| <input type="checkbox"/> Truly® Jacket - 1 yd.                   | <input type="checkbox"/> CE2 - 2 yds.                      | <input type="checkbox"/> Plot Twist™ Seat Top - 1 yds     |
| <input type="checkbox"/> Truly® Wrap - 1 yd.                     | <input type="checkbox"/> CE2 w/ Pillowtop (CE2-P) - 3 yds. | <input type="checkbox"/> Plot Twist™ Side Panel - 1.5 yd. |
| <input type="checkbox"/> Tibidi® Seat (TD2-S) - 1 yd.            | <input type="checkbox"/> Werksy® Full Upholstery - 1 yds.  | <input type="checkbox"/> Plot Twist™ Back Rest - 1 yd.    |
| <input type="checkbox"/> Tibidi® Seat and Back (TD2-F) - 1.5 yd. | <input type="checkbox"/> Other _____                       |   |

## Ship Fabric To:

ATTN: Fabric/COM Testing Dept.  
 Tag: *(your dealer name goes here)*  
 OM Seating  
 1110 South Mildred Avenue  
 Ontario, CA 91761

### Internal Use Only

CUSTOMER ORDER #	FABRIC RECEIVED DATE	TEST BY DATE
APPROVED BY CS (REVIEWED BY: PRO. DEV/PRD)		LOGGED BY
COMMENTS		



# Optional Arm Kit, Arm Tops & Arm Pads



## Features:

- Arm Rests
- Arm Pads
- Arm Tops



# Arm Matrix

## “WELL-ARMED” (FOR GOOD ERGONOMICS)





40+ everyday arms, 5 different arm tops (i.e., pads with motion), myriad additional custom combinations... I guess you could say we believe in offering choices to our customers!

Choosing arms to fit your working style is important. Yet, when it comes to arm selection, we have found that opinions vary widely. Some would say that good arms get out of your way during work, and then are available as occasional rests for when you need a break from the action.

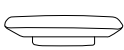

Others believe that arms are meant to offer continuous support even while working... witness the KR100-51M track arms which are “move with you as you work” specialty arms that we developed for Google employees to use in a book-scanning project.

No matter your personal philosophy on arms, we’ve got enough choices to satisfy even the Goldilocks amongst you with something that is “just right”.

Use this matrix as a starting point for just some of our more popular arm models; a reference to explain some of the more common model numbers you’d order, depending on which arm function/style you are seeking...

Arm Frame Description	Regular Arm	ARM PAD		ARM TOPS		
		Memosoft Pads (-M)	5-way Adjustable (-RP45)	6-way Adjustable (-RP50)	6-way Adjustable & Lockable (-RP65)	Specialty Arm (-RP51M)
						
<b>T-ARMS</b>						
Low (2.75" range) Starting height	N/A	KR100M	KR100-45	KR100-50	KR100-65	KR100-51M
Avg. (2.75" range) Starting height	KR200	KR200M	KR100-45	KR200-50	KR200-65	KR200-51M
Tall (2.75" range) Starting height	KR300	KR300M	KR300-45	KR300-50	KR300-65	N/A
Tall (4.25" range) Starting height	JR77	JR77M	JR77-45	JR77-50	JR77-65	N/A
<b>FORWARD SLANTING</b>						
Tall (4.25" range) Avg. starting height	JR39	JR39M	JR49	JR59	JR69	N/A
<b>OM5 Arm Codes</b>	MR5 / 'A'	MRM	MR45	MR50	MR65	N/A

## EXECUTIVE STYLE ARMS\*

EXECUTIVE		
Polished Aluminum loop top arms	AR81	
Height/width adjustable polished loop top arm with inward pivoting arm top	AR485	

\* Check relevant arm model descriptions for compatibility.



For pricing and more specifics about these (and even more) arm choices, please reference the following pages. For experienced guidance and/or suggestions, please contact your favorite OM representative or the factory directly - toll free 877 776 5678



# Optional Arm Kits

Fixed Arms | 1D Motion Arms

Arm your chair with a fit that's right for you.

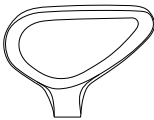
FIXED ARMS					
Model	Group	List	Height Adj. Width Adj. (per side)	Approx. Ht. from Seat (lowest) <sup>1</sup>	Description
AR82-PLH	Group 1	\$199.00	N/A	~ 8.5"	Polished aluminum reverse cantilever with standard OM black leather arm pads. (Available on Affirm, CE2 (view series notes for details), Truly., Paramount, and Yes Series only. Not available on chairs over 350 lbs.)  <b>12-year</b> limited warranty on arm frames or <b>5-year</b> limited warranty on arm pads <sup>2</sup>
					
AR82-BLK	Group 1	\$186.00	N/A	~ 8.5"	Black powdercoated reverse cantilever with standard OM black leather arm pads. (Available on Affirm, CE2 (view series notes for details), Truly., Paramount, and Yes Series only. Not available on chairs over 350 lbs.)  <b>12-year</b> limited warranty on arm frames or <b>5-year</b> limited warranty on arm pads <sup>2</sup>
					
KR48	Group 1	\$104.00	N/A	~ 9.75"	Fixed loop arms  <b>12-year</b> limited warranty <sup>2</sup>
					

<sup>1</sup> All arm dimensions are approximate as actual measurements will vary depending on a variety of factors: cushion contour(s), seat upholstery, memory foam, etc.  
<sup>2</sup> Warranty on all arms does not cover conditions beyond standard commercial use.

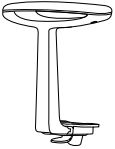
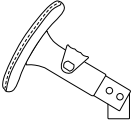
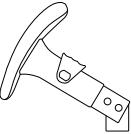
1D MOTION HEIGHT OR WIDTH ADJUSTABILITY					
Model	Group	List	Height Adj. Width Adj. (per side)	Approx. Ht. from Seat (lowest) <sup>1</sup>	Description
AR81	Group 4	\$205.00	w = 1.75"	~ 8.25"	Width adjustable, fixed height polished aluminum loop top arm  <b>12-year</b> limited warranty on arm frames or <b>5-year</b> limited warranty on arm pads <sup>2</sup>
					
JRBN	Group 1 Specialty Arm	\$267.00	h = 2.5"	~ 9.25"	Fixed width T-arms with fold back feature and trigger-style height control with ballistic nylon upholstered arm pads.  <b>5-year</b> limited warranty on arm frames & <b>2-year</b> limited warranty on upholstered arm pads <sup>2</sup>
					
JRPD	Group 1 Specialty Arm	\$267.00	h = 2.5"	~ 9.25"	Fixed width T-arms with fold back feature and trigger-style height control with Memosoft arm pads.  <b>5-year</b> limited warranty on arm frames & <b>5-year</b> limited warranty on arm pads <sup>2</sup>
					

<sup>1</sup> **WHEN MEASURING ARMS** All arm dimensions are approximate as actual measurements will vary depending on a variety of factors: cushion contour(s), seat upholstery, memory foam, etc.  
<sup>2</sup> Warranty on all arms does not cover conditions beyond standard commercial use.

Arm kits contain left and right side arms, prices above are per set. ; See page 180 for OM warranty information. ; Pricing and specifications subject to change without notification.

# Optional Arm Kits

## 1D Motion Arms

Arm your chair with a fit that's right for you.

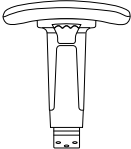
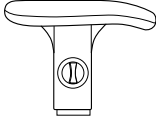
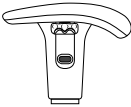
1D MOTION		HEIGHT OR WIDTH ADJUSTABILITY (continued)			
Model	Group	List	Height Adj. Width Adj. (per side)	Approx. Ht. from Seat (lowest) <sup>1</sup>	Description
	Group 1 <b>JR77</b>	<b>\$100.00</b>	<b>h = 4.25"</b>	<b>~ 8.25"</b>	Fixed width, height adjustable T-arms with molded arm pads  <b>12-year</b> limited warranty on arm frames & <b>5-year</b> limited warranty on arm pads <sup>2</sup>
	<b>JR77M</b>	<b>\$144.00</b>	<b>h = 4.25"</b>	<b>~ 8.25"</b>	Same as JR77 with Memosoft arm pads
	Group 1	<b>\$70.00</b>	<b>h = 2.25"</b>	<b>~ 8.5"</b>	Fixed width, turn-knob height adjustable T-arms  <b>12-year</b> limited warranty on arm frames & <b>5-year</b> limited warranty on arm pads <sup>2</sup>
	<b>KR23</b>	<b>\$65.00</b>	<b>h = 3.5"</b>	<b>~ 6.5"</b>	Fixed width, height adjustable T-arms Not available on MX models and chairs rated 350 lbs.  <b>7-year</b> limited warranty on arm frames & <b>2-year</b> limited warranty on arm pads <sup>2</sup>
	Group 1 <b>KR25</b>	<b>\$70.00</b>	<b>h = 2.75"</b>	<b>~ 8.25"</b>	Fixed width, height adjustable T-arms featuring natural grip control  <b>12-year</b> limited warranty on arm frames & <b>5-year</b> limited warranty on arm pads <sup>2</sup>
	<b>KR25M</b>	<b>\$104.00</b>	<b>h = 2.75"</b>	<b>~ 8.25"</b>	Same as KR25 with Memosoft arm pads

<sup>1</sup> **WHEN MEASURING ARMS** All arm dimensions are approximate as actual measurements will vary depending on a variety of factors: cushion contour(s), seat upholstery, memory foam, etc.

<sup>2</sup> Warranty on all arms does not cover conditions beyond standard commercial use.

Arm kits contain left and right side arms, prices above are per set. ∴ See page 180 for OM warranty information. Pricing and specifications subject to change without notification.





# Optional Arm Kits

2D Motion Arms | 3D Motion Arms

Arm your chair with a fit that's right for you.

## 2D MOTION HEIGHT AND WIDTH ADJUSTABILITY

RELATED ARM FRAMES

Model	Group	List	Height Adj. Width Adj. (per side)	Approx. Ht. from Seat (lowest) <sup>1</sup>	Description
<b>JR39 / JR39M</b> 	Group 4				
	<b>JR39</b>	<b>\$132.00</b>	<b>h = 4.25"</b> <b>w = 1.75"</b>	<b>~ 7.25"</b>	Height and width adjustable forward slanting T-arms with soft touch width adjustment trigger
	<b>JR39M</b>	<b>\$169.00</b>	<b>h = 4.25"</b> <b>w = 1.75"</b>	<b>~ 7.25"</b>	Same as JR39 with Memosoft arm pads  <b>12-year</b> limited warranty on arm frames & <b>5-year</b> limited warranty on arm pads <sup>2</sup>
<b>KR100M</b> <i>(formerly KR240M)</i> 	Group 1	<b>\$144.00</b>	<b>h = 2.75"</b> <b>w = 1.25"</b>	<b>~ 5.25"</b>	<b>LOW</b> Height and width adjustable, removable T-arms with natural grip control and Memosoft arm pads  <b>12-year</b> limited warranty on arm frames & <b>5-year</b> limited warranty on arm pads <sup>2</sup>
<b>KR200 / KR200M</b> 	Group 1				
	<b>KR200</b>	<b>\$119.00</b>	<b>h = 2.75"</b> <b>w = 1.25"</b>	<b>~ 6.25"</b>	<b>AVERAGE</b> Height and width adjustable, removable T-arms with natural grip control
	<b>KR200M</b>	<b>\$153.00</b>	<b>h = 2.75"</b> <b>w = 1.25"</b>	<b>~ 6.25"</b>	Same as KR200 with Memosoft arm pads  <b>12-year</b> limited warranty on arm frames & <b>5-year</b> limited warranty on arm pads <sup>2</sup>
<b>KR300 / KR300M</b> 	Group 1				
	<b>KR300</b>	<b>\$144.00</b>	<b>h = 2.75"</b> <b>w = 1.25"</b>	<b>~ 7.75"</b>	<b>TALL</b> Height and width adjustable, removable T-arms with natural grip control
	<b>KR300M</b>	<b>\$178.00</b>	<b>h = 2.75"</b> <b>w = 1.25"</b>	<b>~ 7.75"</b>	Same as KR300 with Memosoft arm pads  <b>12-year</b> limited warranty on arm frames & <b>5-year</b> limited warranty on arm pads <sup>2</sup>

<sup>1</sup> **WHEN MEASURING ARMS** All arm dimensions are approximate as actual measurements will vary depending on a variety of factors: cushion contour(s), seat upholstery, memory foam, etc.

<sup>2</sup> Warranty on all arms does not cover conditions beyond standard commercial use.

# Optional Arm Kits

3D Motion Arms | 4D Motion Arms





Arm your chair with a fit that's right for you.

## 3D MOTION HEIGHT, WIDTH AND ADDITIONAL DIMENSIONAL ADJUSTABILITY (continued)

Model	Group	List	Height Adj. Width Adj. (per side)	Approx. Ht. from Seat (lowest) <sup>1</sup>	Description
 AR485	Group 4	\$349.00	h = 4" w = 1.75"	~ 7"	Height and width adjustable polished aluminum loop top arms with pivoting motion.  <b>12-year</b> limited warranty on arm frames & <b>5-year</b> limited warranty on arm pads <sup>2</sup>

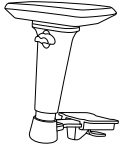
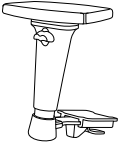
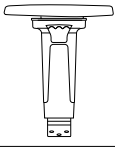
<sup>1</sup> All arm dimensions are approximate as actual measurements will vary depending on a variety of factors: cushion contour(s), seat upholstery, memory foam, etc.  
<sup>2</sup> Warranty on all arms does not cover conditions beyond standard commercial use.

## 4D MOTION HEIGHT, WIDTH AND 2 ADDITIONAL DIMENSIONAL ADJUSTABILITY (see description below)

Model	Group	List	Height Adj. Width Adj. (per side)	Approx. Ht. from Seat (lowest) <sup>1</sup>	Description
 JR49	Group 4	\$196.00	h = 4.25" w = 2.75"	~ 8.75"	Height and width adjustable, forward slanting T-arms with soft touch width adjustment trigger, fore-aft, side-side and inward pivoting arm tops (RP-45)  <b>12-year</b> limited warranty on arm frames & <b>5-year</b> limited warranty on arm pads <sup>2</sup>
 JR69	Group 4	\$196.00	h = 4.25" w = 2.75"	~ 8.25"	Height and width adjustable, forward slanting T-arm with soft touch width adjustment trigger, lockable arm top, fore-aft, side-side, pivoting arm top (RP-65)  <b>12-year</b> limited warranty on arm frames & <b>5-year</b> limited warranty on arm pads <sup>2</sup>
 JR77-65	Group 1	\$220.00	h = 4.25"	~ 9.5"	<b>TALL</b> Fixed width, height adjustable T-arms with lockable arm top, fore-aft, side-side, pivoting arm top (RP-65)  <b>12-year</b> limited warranty on arm frames & <b>5-year</b> limited warranty on arm pads <sup>2</sup>
 KR100-45 (formerly KR445)	Group 1	\$185.00	h = 2.75" w = 2.25"	~ 6.75"	<b>LOW</b> Height and width adjustable, removable T-arms with fore-aft, side-side, and inward pivoting arm top (RP-45)  <b>12-year</b> limited warranty on arm frames & <b>5-year</b> limited warranty on arm pads <sup>2</sup>
 KR200-45	Group 1	\$224.00	h = 2.75" w = 2.25"	~ 7.75"	<b>AVERAGE</b> Height and width adjustable, removable T-arms with fore-aft, side-side, and inward pivoting arm top (RP-45)  <b>12-year</b> limited warranty on arm frames & <b>5-year</b> limited warranty on arm pads <sup>2</sup>
 KR300-45	Group 1	\$249.00	h = 2.75" w = 2.25"	~ 9.25"	<b>TALL</b> Height and width adjustable, removable T-arms with fore-aft, side-side, and inward pivoting arm top (RP-45)  <b>12-year</b> limited warranty on arm frames & <b>5-year</b> limited warranty on arm pads <sup>2</sup>

RELATED ARM FRAMES

<sup>1</sup> **WHEN MEASURING ARMS** All arm dimensions are approximate as actual measurements will vary depending on a variety of factors: cushion contour(s), seat upholstery, memory foam, etc.  
Warranty on all arms does not cover conditions beyond standard commercial use.

# Optional Arm Kits





## 4D Motion Arms

Arm your chair with a fit that's right for you.

### 4D MOTION HEIGHT, WIDTH AND 2 ADDITIONAL DIMENSIONAL ADJUSTABILITY (continued)

(fore-aft & inward pivot arm top (RP-65))

RELATED ARM FRAMES

Model	Group	List	Height Adj. Width Adj. (per side)	Approx. Ht. from Seat (lowest) <sup>1</sup>	Description
<b>KR100-65</b> <i>(formerly KR465)</i>	Group 1	\$195.00	<b>h = 2.75"</b> <b>w = 2.25"</b>	~ 6"	<b>LOW</b> Height and width adjustable, removable T-arms with lockable arm top, fore-aft, side-side, pivoting arm top (RP-65)  <b>12-year</b> limited warranty on arm frames & <b>5-year</b> limited warranty on arm pads <sup>2</sup>
					
<b>KR200-65</b>	Group 1	\$234.00	<b>h = 2.75"</b> <b>w = 2.25"</b>	~ 7"	<b>AVERAGE</b> Height and width adjustable, removable T-arms with lockable arm top, fore-aft, side-side, pivoting arm top (RP-65)  <b>12-year</b> limited warranty on arm frames & <b>5-year</b> limited warranty on arm pads <sup>2</sup>
					
<b>KR300-65</b>	Group 1	\$259.00	<b>h = 2.75"</b> <b>w = 2.25"</b>	~ 8.5"	<b>TALL</b> Height and width adjustable, removable T-arms with lockable arm top, fore-aft, side-side, pivoting arm top (RP-65)  <b>12-year</b> limited warranty on arm frames & <b>5-year</b> limited warranty on arm pads <sup>2</sup>
					
<b>KR100-51M</b> <i>(formerly KR251M)</i>	Group 1 Specialty Arm	\$205.00	<b>h = 2.75"</b> <b>w = 6.25"</b>	~ 7.5"	<b>LOW</b> Height and width adjustable, removable T-arms with ultra-mobility arm tops that extend forward, pivot a full 360° at 2 different points; serves as a light-duty track arm to move with your hands as you work (RP-51M).  <b>12-year</b> limited warranty on arm frame <b>5-year</b> limited warranty on arm pads & <b>1-year</b> limited warranty on specialty arm tops <sup>2</sup>  <i>Note:</i> This is a specialty arm that is NOT designed to bear substantial weight and is NOT recommended for use on heavy-duty.
					
<b>KR200-51M</b>	Group 1 Specialty Arm	\$234.00	<b>h = 2.75"</b> <b>w = 6.25"</b>	~ 8.5"	<b>AVERAGE</b> Height and width adjustable, removable T-arms with ultra-mobility arm tops that extend forward, pivot a full 360° at 2 different points; serves as a light-duty track arm to move with your hands as you work (RP-51M).  <b>12-year</b> limited warranty on arm frame <b>5-years</b> on arm top and arm pad <sup>2</sup> <b>1-year</b> limited warranty on specialty arm tops <sup>2</sup>  <i>Note:</i> This is a specialty arm that is NOT designed to bear substantial weight and is NOT recommended for use on heavy-duty.
					

RELATED ARM FRAMES

<sup>1</sup> **WHEN MEASURING ARMS** All arm dimensions are approximate as actual measurements will vary depending on a variety of factors: cushion contour(s), seat upholstery, memory foam, etc.

<sup>2</sup> Warranty on all arms does not cover conditions beyond standard commercial use.





Arm kits contain left and right side arms, prices above are per set. ∴ See page 180 for OM warranty information. ∴ Pricing and specifications subject to change without notification.

# Optional Arm Kits

4D+ Motion Arms

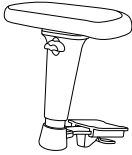
Arm your chair with a fit that's right for you.

**4D+ MOTION** FULL MOTION: HEIGHT, WIDTH AND MORE ADJUSTABILITY (see description below)

Model	Group	List	Height Adj. Width Adj. (per side)	Approx. Ht. from Seat (lowest) <sup>1</sup>	Description
 <b>JR59</b>	Group 4	\$205.00	h = 4.25" w = 3.75"	~ 8.5"	Height and width adjustable, forward slanting T-arms with soft touch width adjustment and 6-way ultra adjustable, omni directional arm top (RP-50)  <b>12-year</b> limited warranty on arm frames & <b>5-year</b> limited warranty on arm pads <sup>2</sup>
 <b>KR100-50</b> (formerly KR540)	Group 1	\$205.00	h = 2.75" w = 3.25"	~ 6.75"	<b>LOW</b> Height and width adjustable, removable T-arms with 6-way ultra adjustable, omni directional arm top (RP-50)  <b>12-year</b> limited warranty on arm frames & <b>5-year</b> limited warranty on arm pads <sup>2</sup>
 <b>KR200-50</b> (formerly KR500)	Group 1	\$244.00	h = 2.75" w = 3.25"	~ 7.75"	<b>AVERAGE</b> Height and width adjustable, removable T-arms with 6-way ultra adjustable, omni directional arm top (RP-50 arm tops)  <b>12-year</b> limited warranty on arm frames & <b>5-year</b> limited warranty on arm pads <sup>2</sup>
 <b>KR300-50</b> (formerly KR600)	Group 1	\$269.00	h = 2.75" w = 3.25"	~ 9.25"	<b>TALL</b> Height and width adjustable, removable T-arms with 6-way ultra adjustable, omni directional arm top (RP-50)  <b>12-year</b> limited warranty on arm frames & <b>5-year</b> limited warranty on arm pads <sup>2</sup>

RELATED ARM FRAMES









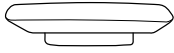
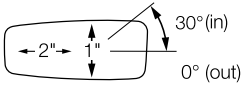

<sup>1</sup> **WHEN MEASURING ARMS** All arm dimensions are approximate as actual measurements will vary depending on a variety of factors: cushion contour(s), seat upholstery, memory foam, etc.

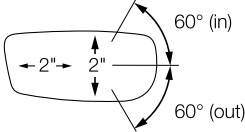
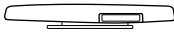
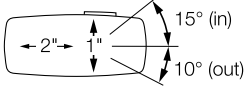
<sup>2</sup> Warranty on all arms does not cover conditions beyond standard commercial use.

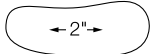
Arm kits contain left and right side arms, prices above are per set. ∴ See page 180 for OM warranty information . ∴ Pricing and specifications subject to change without notification.

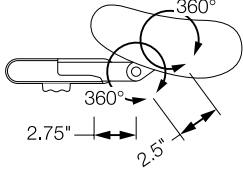
# Optional Arm Tops & Arm Pads

Arm tops and Arm pads

Arm Tops	Arm top Movement	List	Description
<b>RP-45</b> 		<b>\$115.00*</b> per set	5-way arm top with smooth fore-aft, side-side, and inward pivoting arm caps (retrofits to most Group 1 and Group 4 arms)  <b>5-year</b> limited warranty arm tops with arm pads
<b>RP-50</b> 		<b>\$135.00*</b> per set	6-way, ultra-adjustable, omni directional arm top (retrofits to most Group 1 and Group 4 arms)  <b>5-year</b> limited warranty arm tops with arm pads
<b>RP-65</b> 		<b>\$135.00*</b> per set	6-way adjustable & lockable arm top (retrofits to most Group 1 and Group 4 arms)  <b>5-year</b> limited warranty arm tops with arm pads
<b>RP-XM</b>  Specialty Arm Top		<b>\$145.00</b> per set	1-way adjustable arm top (retrofits to most Group 1 and Group 4 arms)  <b>5-year</b> limited warranty arm pads <b>1-year</b> limited warranty on specialty arm tops  <i>Note:</i> This is a specialty arm that is NOT designed to bear substantial weight and is NOT recommended for use on MX or HD models.
<b>RP-51M</b>  Specialty Arm Top		<b>\$145.00</b> per set	Ultra-mobility arm tops that extend forward, pivot a full 360° at 2 different points; serves as a light-duty track arm to move with your hands as you work.  <b>5-year</b> limited warranty on arm pads <b>1-year</b> limited warranty on specialty arm tops  <i>Note:</i> This is a specialty arm that is NOT designed to bear substantial weight and is NOT recommended for use on MX or HD models.
Arm Pads		List	Description
<b>Type 1</b> 	<i>Arm pad codes will vary. See description at right for details.</i>	<b>\$34.00</b> per set  <i>Representative image - actual arm pad may vary</i>	Arm pads for the following arms: BR5, JR39, JR77, KR21, KR23, KR25, and KR200
<b>Type 2</b> 	<i>Arm pad codes will vary. See description at right for details.</i>	<b>\$44.00</b> per set  <i>Representative image - actual arm pad may vary</i>	Arm pads for the following arms: KR25M (Memosoft), KR100-51M (Memosoft), and KR200M (Memosoft), and OM5 MR5 pad
<b>Type 3</b> 	<i>Arm pad codes will vary. See description at right for details.</i>	<b>\$84.00</b> per set  <i>Representative image - actual arm pad may vary</i>	Arm pads for AR81, AR485 and JRBN arms

## WHEN ORDERING ARM PADS

Order arm pads by specific arm model numbers found under DESCRIPTION. OM can NOT fulfill arm pad orders that use Type only when ordering.

NOTES: Overall width of chair will be approximately increased 5" with Group 1 arms. Overall weight of chair will be increased by approximately 8-12 pounds.

\*Warranty on arms does not cover conditions beyond standard commercial use.

Arm kits contain left and right side arms, prices above are per set. ; See page 180 for OM warranty information. ; Pricing and specifications subject to change without notification.





# Mechanism Guide

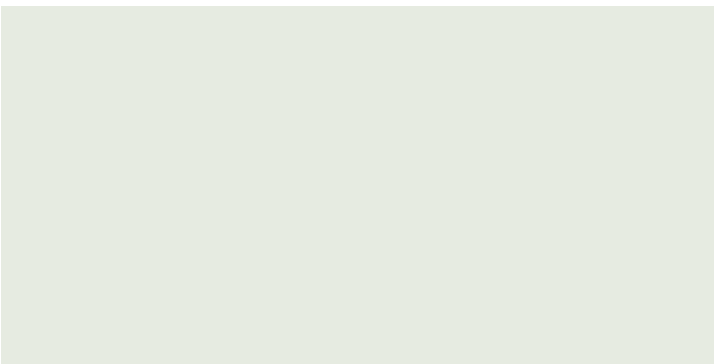

# Mechanism Guide

Having adjustments on your chair is great, but can get confusing at times. To help you better understand our different mechanisms, see below and explore our most popular offerings shared across our different product series. OM Seating is here to support all the different ways you work from light tasking to 24/7 multi-shift. The information below are intended to highlight the different functionality and adjustability. Pick the right fit for you.

**(-0gs) Guest Swivel**

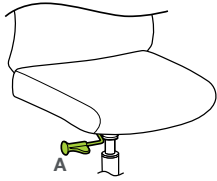

A. Seat Height

**(-4a) Quick-Adjust Synchro (Simple)**

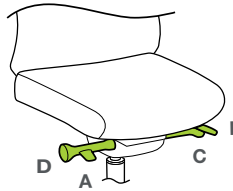

A. Seat Height  
B. Seat Slider  
C. 5 Tilt Range Limiter Positions  
D. 7 Tilt Tension Quick Adjust Setting

**(-0) Simple Synchro**

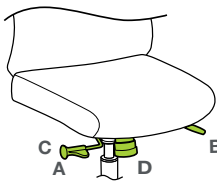

A. Seat Height  
B. Seat Slider  
C. 1 Position Tilt Lock (Push In)  
D. Tilt Tension

**(-4b) Quick-Adjust Synchro (Advanced)**

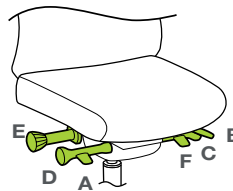

A. Seat Height  
B. Seat Slider  
C. 5 Tilt Range Limiter Positions  
D. 7 Tilt Tension Quick Adjust Settings  
E. Independent Back Angle  
F. Forward Seat Angle (for perching & back relief)

**(-1) Management Synchro**

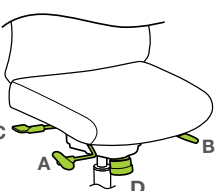

A. Seat Height  
B. Seat Slider  
C. 3 Position Tilt Lock\*  
D. Tilt Tension

**\*Positive Back Release**  
After unlocking the (C) Tilt Lock Lever, lean into the backrest to release the tilt lock & resume normal tilt recline motion.

**(-6) Body-Activated Motion**

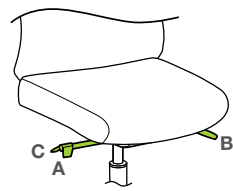

A. Seat Height  
B. Seat Slider  
C. 3 Position Tilt Lock\*

**\*Positive Back Release**  
After unlocking the (C) Tilt Lock Lever, lean into the backrest to release the tilt lock & resume normal tilt recline motion.

**(-2) Executive Synchro**

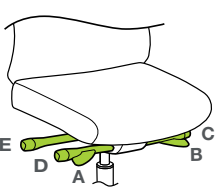

A. Seat Height  
B. Seat Slider  
C. 5 Position Tilt Lock\*  
D. Side Mounted Tilt Tension (telescopes out/in)  
E. Independent Back Angle

Synchronized Motion

Synchronized Motion (Quick-Adjust)

Self-Weighing Motion

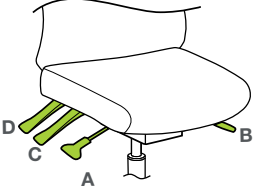
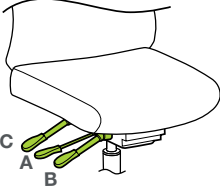
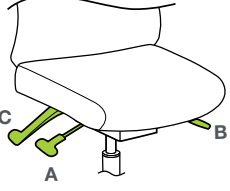
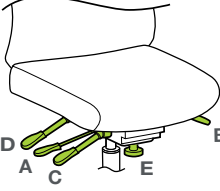
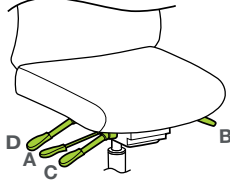
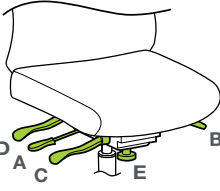
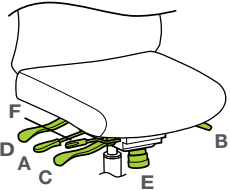
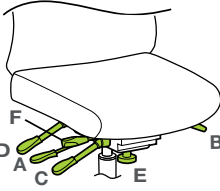
Multi-Function (Simple)	<b>(-7a) Simple Multi-Function</b>	 <ul style="list-style-type: none"> <li>A. Seat Height</li> <li>B. Seat Slider</li> <li>C. Infinite Seat Tilt/Lock (free float)</li> <li>D. Infinite Back Tilt/Lock (free float)</li> </ul>	<b>(-7bNS) Simple Multi-Function (Without Slider)</b>	 <ul style="list-style-type: none"> <li>A. Seat Height</li> <li>B. Seat/Back Tilt and Lock (free-float)</li> <li>C. Independent Back Angle</li> </ul>
	<b>(-7aCLS) Simple Multi-Function</b>	 <ul style="list-style-type: none"> <li>A. Seat Height</li> <li>B. Seat Slider</li> <li>C. Independent Back Angle</li> </ul>	<b>(-7HD) Simple Multi-Function (Heavy Duty)</b>	 <ul style="list-style-type: none"> <li>A. Seat Height</li> <li>B. Seat Slider</li> <li>C. Seat/Back Tilt and Lock with Rocking Seat Tilt (free-float)</li> <li>D. Independent Back Angle</li> <li>E. Tilt Tension</li> </ul>
	<b>(-7b) Simple Multi-Function</b>	 <ul style="list-style-type: none"> <li>A. Seat Height</li> <li>B. Seat Slider</li> <li>C. Seat/Back Tilt and Lock (free-float)</li> <li>D. Independent Back Angle</li> </ul>	<b>(-7MX) Simple Multi-function (Heavy Duty)</b>	 <ul style="list-style-type: none"> <li>A. Seat Height</li> <li>B. Seat Slider</li> <li>C. Seat/Back Tilt and Lock with Rocking Seat Tilt (free-float)</li> <li>D. Independent Back Angle</li> <li>E. Tilt Tension</li> </ul>
Multi-Function (Full)	<b>(-8a) Full Multi-Function</b>	 <ul style="list-style-type: none"> <li>A. Seat Height</li> <li>B. Seat Slider</li> <li>C. Seat/Back Tilt and Lock with Rocking Seat Tilt (free-float)</li> <li>D. Independent Back Angle</li> <li>E. Tilt Tension</li> <li>F. Forward Seat Tilt Stop (for perching and back relief)</li> </ul>	<b>(-8b) Full Multi-Function</b>	 <ul style="list-style-type: none"> <li>A. Seat Height</li> <li>B. Seat Slider</li> <li>C. Seat/Back Tilt and Lock with Rocking Seat Tilt (free-float)</li> <li>D. Independent Back Angle</li> <li>E. Tilt Tension</li> <li>F. Infinite Forward Tilt Seat Angle (for perching and back relief)</li> </ul>



# Optional Casters Cylinders & Headrests









## Features:

- Casters for all types of flooring
- Cylinders for achieving various seat heights
- Non-standard upholstered headrest options

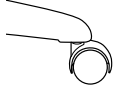

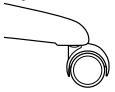
# Casters

## Guidelines and Selection

	List \$ (Upcharge)	List \$ (Buy)	Description
<b>CAS-REG</b> 	N/A	\$30.00	<b>Regular Caster</b> Designed for use on carpet (5 per set, standard on most chairs)
<b>GLDR</b> 	N/A	\$30.00	<b>Glide</b> Keeps the chair stationary at all times (5 per set)
<b>50SS</b> (formerly CAS0050-SS) 	\$25.00	\$45.00	<b>Safety Soft Caster</b> Minimizes chair movement when NOT in use (5 per set)
<b>50R</b> (formerly CAS0050-RB) 	\$35.00	\$55.00	<b>Reverse Braking Caster</b> Restricted chair movement when chair IS in use (5 per set)
<b>65MS</b> (formerly CAS0065-S) 	\$25.00	\$45.00	<b>Multi-Surface Soft Caster</b> Dual-tone; designed for wood, tile and smooth surfaces (5 per set)
<b>RUB</b> (formerly CAS-RUB) 	\$25.00	\$45.00	<b>Rubber Caster</b> Designed for concrete and other hard surfaces (5 per set)

Note: Not available on MXIU and other high weight limit chairs (i.e., 350 lbs. and up).

OM provides you with a range of caster options to accommodate your working environment. Tailor your caster selection specifically to the type of flooring where your seating will be used. Refer to the chart below to help you choose the caster that is right for you.

SOFTTEST SURFACE HARDEST SURFACE

	Carpet	Chair Mat	Wood	Tile	Linoleum	Concrete
<b>Regular Caster</b>	<b>Excellent!</b>	Fair	Poor	Poor	Poor	Poor
<b>Glide</b>	Fair	Fair	Fair	Fair	Fair	Fair
<b>Safety Soft Caster</b>	Poor	<b>Excellent!</b>	<b>Excellent!</b>	<b>Excellent!</b>	<b>Excellent!</b>	<b>Excellent!</b>
<b>Reverse Braking Caster</b>	Poor	Fair	Fair	Fair	Fair	Fair
<b>Soft Caster ("Dual-soft")</b>	<b>Excellent!</b>	<b>Excellent!</b>	<b>Excellent!</b>	<b>Excellent!</b>	<b>Excellent!</b>	<b>Excellent!</b>
<b>Rubber Caster</b>	Fair	Fair	Fair	Fair	<b>Excellent!</b>	<b>Excellent!</b>

Similar to the way tires on a car eventually wear out, even the most well-made casters are subject to wear and tear. While performing routine maintenance will extend the life of your casters, eventually you may need to replace them.

Be advised that all the options listed above may not be applicable to all models in our price list. Please call OM for details or clarification. Pricing and specifications subject to change without notification.

# Cylinders

## Guidelines and Selection

	List \$ (Upcharge)	List \$ (Buy)	Description
<b>5AF</b> <i>(formerly CYL-5)</i>	<b>\$20.00</b>	<b>\$70.00</b>	5" cylinder for most task and executive chairs (black)
<b>5CR</b> <i>(formerly CYL-5CR)</i>	<b>\$20.00</b>	<b>\$85.00</b>	5" cylinder for most task and executive chairs. Chrome housing with black colored piston
<b>5WWY</b> <i>(formerly CYL-5WWY)</i>	<b>\$20.00</b>	<b>\$85.00</b>	5" white cylinder for OM5 Active Tasker and Werksy Tasker (p. 107, 123)
<b>6CHD</b> <i>(formerly CYL-6CHD)</i>	<b>\$40.00</b>	<b>\$100.00</b>	6" chrome heavy-duty cylinder <b>(check with factory for model compatibility)</b> .
<b>8CHD</b> <i>(formerly CYL-8CHD)</i>	<b>\$30.00</b>	<b>\$95.00</b>	8" chrome heavy-duty cylinder to accommodate intermediate drafting desk
<b>10CHD</b> <i>(formerly CYL-10CHD)</i>	<b>\$30.00</b>	<b>\$95.00</b>	10" chrome heavy-duty cylinder for drafting stools

*Available on chairs that are not BC or WS (except WS15VS and WS16) Series.*

Cylinders below are heavy-duty versions available on certain OM models **(check with factory for model compatibility)**

<b>4HD</b> <i>(formerly CYL-4HD)</i>	<b>\$30.00</b>	<b>\$95.00</b>	4" black heavy-duty cylinder <b>(check with factory for model compatibility)</b>
<b>5HD</b> <i>(formerly CYL-5HD)</i>	<b>\$30.00</b>	<b>\$95.00</b>	5" black heavy-duty cylinder <b>(check with factory for model compatibility)</b>
<b>6SHD</b> <i>(formerly CYL-6SHD)</i>	<b>\$40.00</b>	<b>\$100.00</b>	6" black super heavy-duty cylinder <b>(check with factory for model compatibility)</b>

Choosing the appropriate cylinder for both your working environment and working style is critical to proper ergonomics and your long-term seating comfort.

Cylinders (aka Gas Lifts or Pneumatic Cylinders) are a paradox. While they are one of the easiest — and most important — parts of your chair to adjust, they can also be one of the hardest parts of your chair to understand. Thankfully there is only one main area that you really need to consider when specifying for that perfect fit: Travel Range.

Travel range is usually expressed in approximate inches and is the total distance that the telescoping portion of the assembly can travel. A 5 inch cylinder has approximately 5 inches of travel from full compression to full extension, a 8 inch cylinder has approximately 8 inches of travel, respectively.

When considering the Travel Range for your seating needs, it is important to bear in mind that your working environment and style together determine what's appropriate for you. See the chart below for more details.

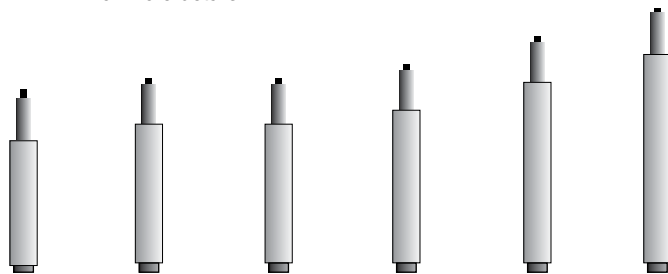

Category	Desk Height				Counter Height	
	88 mm	121 mm	121 mm	162 mm	202 mm	262 mm
<b>Actual Travel</b>						
<b>Comparative Max. Height*</b> <small>(As measured from cyl-5 as a "standard")</small>	-2.5"	standard	standard	+4"	+7.3"	+13.5"
<b>Comparative Min. Height*</b> <small>(As measured from cyl-5 as a "standard")</small>	-1.3"	standard	standard	+2.5"	+4.3"	+8.2"

\* All measurements are approximate and are based on switching cylinder heights on otherwise the same chair, with the same base and casters.

BIFMA UTFF (Ultimate Test For Fit) for the work chair states that users should be able to sit with their feet comfortably on the floor or footrest without undue pressure on the underside of the thighs. The thigh-to-torso angle should not be less than 90°.

# Headrest

## Non-standard Upholstered Headrest Options

Available on select Affirm and Yes models only. Contact OM Seating for details.

### -HRL

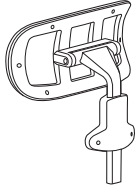

Textile Grade-In	List
All MESH	\$ 78.00
Grade 1 / C.O.M.	\$108.00
Grade 2 / Grade-in A	\$115.00
Grade 3 / Grade-in B	\$122.00
Grade 4 / Grade-in C	\$129.00
Grade 5 / Grade-in D	\$136.00
Grade 6 / Grade-in E	\$143.00
LG1 (Evita) / C.O.L.	\$140.00
LG2 (Lena-LDEL, LLUT, LORC only)*	\$150.00
LG3 (Vulcano-LMIT, LSTG only)*	\$160.00

\*For NON In-Stock colors, check with OM Seating for additional pricing details.

### -HRD



Textile Grade-In	List
Grade 1 / C.O.M.	\$124.00
Grade 2 / Grade-in A	\$131.00
Grade 3 / Grade-in B	\$138.00
Grade 4 / Grade-in C	\$145.00
Grade 5 / Grade-in D	\$152.00
Grade 6 / Grade-in E	\$159.00
LG1 (Evita) / C.O.L.	\$156.00
LG2 (Lena-LDEL, LLUT, LORC only)*	\$166.00

\*For NON In-Stock colors, check with OM Seating for additional pricing details.

Available on OM5® Series

### -HRD

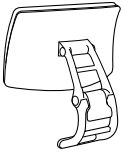

Textile Grade-In	List
Grade 1 / C.O.M.	\$124.00
Grade 2 / Grade-in A	\$131.00
Grade 3 / Grade-in B	\$138.00
Grade 4 / Grade-in C	\$145.00
Grade 5 / Grade-in D	\$152.00
Grade 6 / Grade-in E	\$159.00
LG1 (Evita) / C.O.L.	\$156.00
LG2 (Lena-LDEL, LLUT, LORC only)*	\$166.00
LG3 (Vulcano-LMIT, LSTG only)*	\$176.00

\*For NON In-Stock colors, check with OM Seating for additional pricing details.

Available on Truly® Series only

### -THR

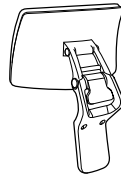

Textile Grade-In	List
Grade 1 / C.O.M.	\$222.00
Grade 2 / Grade-in A	\$229.00
Grade 3 / Grade-in B	\$236.00
Grade 4 / Grade-in C	\$243.00
Grade 5 / Grade-in D	\$250.00
Grade 6 / Grade-in E	\$257.00
LG1 (Evita) / C.O.L.	\$254.00
LG2 (Lena-LDEL, LLUT, LORC only)*	\$264.00
LG3 (Vulcano-LMIT, LSTG only)*	\$274.00

\*For NON In-Stock colors, check with OM Seating for additional pricing details.

Available on select Affirm cushioned, DB, Intensive Use, Maxwell, PA and PT models only. Contact OM Seating for details.

### -HRZA

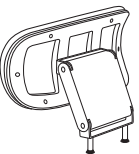

Textile Grade-In	List
All MESH	\$ 78.00
Grade 1 / C.O.M.	\$108.00
Grade 2 / Grade-in A	\$115.00
Grade 3 / Grade-in B	\$122.00
Grade 4 / Grade-in C	\$129.00
Grade 5 / Grade-in D	\$136.00
Grade 6 / Grade-in E	\$143.00
LG1 (Evita) / C.O.L.	\$140.00
LG2 (Lena-LDEL, LLUT, LORC only)*	\$150.00
LG3 (Vulcano-LMIT, LSTG only)*	\$160.00

\*For NON In-Stock colors, check with OM Seating for additional pricing details.



# Additional Upholstery and Options

<b>UPHOLSTERY</b>	<b>List \$ (Upcharge)</b>	<b>List \$ (Buy)</b>	<b>Description</b>
<b>TLC™ Technology</b>	<b>\$98.00</b>	<b>\$198.00</b>	Sigh-producing , dual-density seat cushion featuring 2 different pieces of co-molded foam (comfort + support layers). Call OM for availability and size options.
<b>CFT</b> <i>(formerly UPHCFT)</i>	<b>\$66.00</b>	<b>N/A</b>	Memory foam sub-layer (i.e., viscoelastic foam located underneath HR foam to preserve aesthetics while still enhancing sitting comfort). Call OM for compatibility.
<b>DCSZA</b>	<b>\$98.00</b>	<b>\$198.00</b>	Unique, twice-molded, YES series seat cushion featuring both memory and support foam layers. Call OM for availability and size options.
<b>UPHMF</b>	<b>\$66.00</b>	<b>N/A</b>	5 lbs. memory foam layer applied to surface of seat cushion, underneath fabric
<b>LUM</b>	<b>\$76.00</b>	<b>N/A</b>	Adjustable lumbar option add-on (not available on all models, call OM for details)
<b>UPHDUB1</b>	<b>\$40.00</b>	<b>\$69.00</b>	Upholstery back for small and BC Series task chairs (0.5 yd.)
<b>UPHDUB2</b>	<b>\$50.00</b>	<b>\$83.00</b>	Upholstery back for large and BC Series executive chairs (0.75 yd.)
<b>UPHDUB3</b>	<b>\$70.00</b>	<b>\$102.00</b>	Upholstery back for complex backshells (1 yd.)
<b>UPHDUB-B</b>	<b>\$50.00</b>	<b>N/A</b>	Ballistic Nylon upholstery on backshell
<b>DUB-K</b> <i>(formerly UPHDUB-T)</i>	<b>\$70.00</b>	<b>\$102.00</b>	Upholstery back for chairs using Comfort Knit
<b>UPH-PD</b>	<b>\$70.00</b>	<b>N/A</b>	Durable Ballistic Nylon added to lower half, front portion of backrest. Check with factory.
<b>TB133-1</b>	<b>\$80.00</b>	<b>N/A</b>	Upholstery with fire barrier to meet the former CA-TB133 fire code (use for: AF5_, BC4_, CL1_, CL3_, OM5 Active, TY, WY, YS)
<b>TB133-2</b>	<b>\$119.00</b>	<b>N/A</b>	Upholstery with fire barrier to meet the former CA-TB133 fire code (use for: AF4_, CL4_, GY4G, IU, IUHD, PA, PT)
<b>TB133-3</b>	<b>\$158.00</b>	<b>N/A</b>	Upholstery with fire barrier to meet the former CA-TB133 fire code (use for : 7780, CE2, CE2-P, DB, GY4B, IU79HD/PD, MXIU, PA59, PA69, PC59, PT79_, PTYM_)
<b>UPHCYX</b>	<b>\$98.00</b>	<b>N/A</b>	Concealed ultra-soft foam reservoir to relieve tailbone (coccyx) pressure (Grade 2 Soft Sit and Grade 5 ComfortKnit patterns, only)
<b>UPHCYX-CC</b>	<b>\$98.00</b>	<b>N/A</b>	Visible seat foam cut-out to relieve tailbone (coccyx) pressure (Grade 2 Soft Sit and Grade 5 ComfortKnit patterns, only)
<b>COM-LOGO</b>	<b>CALL</b>	<b>N/A</b>	Call factory for pricing (\$55.56 list minimum per unit)
<b>ESD OPTIONS</b>	<b>List \$ (Upcharge)</b>	<b>List \$ (Buy)</b>	<b>Description</b>
<b>ESDPKG-F</b>	<b>\$200.00</b>	<b>N/A</b>	ESD Package - Fabric: Special assembly to meet ESD requirements. Not an option on all OM models. Call OM for compatibility and pricing.
<b>ESDPKG-V</b>	<b>\$240.00</b>	<b>N/A</b>	ESD Package - Vinyl: Special assembly to meet ESD requirements. Not an option on all OM models. Call OM for compatibility and pricing.
<b>CLEAN ROOM</b>	<b>List \$ (Upcharge)</b>	<b>List \$ (Buy)</b>	<b>Description</b>
<b>UPHCLN</b>	<b>\$125.00</b>	<b>N/A</b>	Upholstery modifications for Cleanroom chairs (can only be used with vinyl or similar). Select models. Check with factory.
<b>UPHCRS</b>	<b>\$50.00</b>	<b>N/A</b>	Clean room seat (only) - use G3 price. Adds vinyl dust cover (no filter added)
<b>BC/WS OPTIONS</b>	<b>List \$ (Upcharge)</b>	<b>List \$ (Buy)</b>	<b>Description</b> (Available on BC and WS Series only)
<b>BSEWS15T</b>	<b>\$42.00</b>	<b>\$77.00</b>	Unibody nylon reinforced black base (R-Base)
<b>FTGBC41</b>	<b>\$16.00</b>	<b>\$59.00</b>	18" chrome footing for BC and WS (or exchange with black plastic footing)
<b>FTG20PL</b>	<b>\$16.00</b>	<b>\$59.00</b>	20" black plastic footing for BC and WS (or exchange with chrome footing)
<b>MISC OPTIONS</b>	<b>List \$ (Upcharge)</b>	<b>List \$ (Buy)</b>	<b>Description</b> (Available on chairs that are not BC Series)
<b>IUPKG</b>	<b>\$110.00</b>	<b>N/A</b>	5" heavy-duty cylinder + CAS0065-S multi-surface casters. Alters usage rating to 24/7 with 7-years' limited warranty. (Does NOT alter weight rating. Not available on all models; check with factory.)
<b>CRMPKG</b>	<b>\$80.00</b>	<b>\$123.00</b>	Chrome package: 5" chrome cylinder and polished aluminum base (base size depends on model selection)
<b>BSE27-YS-PLH</b>	<b>\$55.56</b>	<b>\$166.67</b>	Polished aluminum base option available for most models (check with OM for compatibility)
<b>HRZA</b>	<b>\$122.00</b>	<b>N/A</b>	Black leather-like upholstered 3-way adjustable headrest (not retrofittable. Check with factory for model compatibility).
<b>-TL</b>	<b>\$30.00</b>	<b>N/A</b>	Truncated arm frames for JR-39 and KR-300 based arm frames. Allows in-most arm width position to be used on smaller width seats.
<b>CUSTOM-T1</b>	<b>\$30.00</b>	<b>N/A</b>	Custom Features Upcharge Type 1 (i.e., mechanism changes, etc.)
<b>CUSTOM-T2</b>	<b>\$50.00</b>	<b>N/A</b>	Custom Features Upcharge Type 2 (i.e., mechanism changes, etc.)

\*\* GSPPKG & TLPKG only eligible as upcharge to stool configurations. When altering a chair to a stool configuration, check with OM for eligibility and use "Buy" column pricing.

Note: Be advised that all the options listed above may not be applicable to all models in our price list. † Pricing and specifications subject to change without notification.

---

1110 South Mildred Avenue | Ontario, California 91761  
toll free 877 776 5678  
voice 909 392 5678  
facsimile 909 392 4567



**OMSEATING.COM**  
October 2023