

Tibidi®

Features:

- Begins @\$291 armless / \$361 with arms
- High density stacker, stacks 45 high on a dolly, stacks 25 for upholstered versions
- Slim and minimalist design for multipurpose environments, cafés and private offices
- TD2 - color-matched polycolor on seat, back and arm caps
- TD2-S and TD2-F - seat and full upholstery available for added comfort

















Tibidi (TD2-)

Stacking | Guest | Multi-use

- Tibidi Core Features:**
- HD Stacker
 - Stacks 45 High on Dolly
 - 275 lb. Weight Capacity
 - 7 Year Limited Warranty



Note: Green font color indicates default build for "most popular" configuration of this spread.

1. Model		2. Arms		3. Polycolor (Arms, Back and Seat match)		4. Frame Finish	
Code	List	Code	List	Code	List	Code	List
TD2	\$291	 -N (No arms)	+\$0	 -BK01 Modern Black	+\$0	 -CHM* Chrome	\$0
		 -A (With arms)	+\$70	 -GN04 Moss	+\$0	 -BLK Black	+\$0
				 -BR01 Sand	+\$0	 -WHT White	+\$0
				 -WT03 Snow White	+\$0	*Most durable option for frequent stacking / unstacking.	
				 -BL04 Glacier	+\$0		
				 -GR05 Fog	+\$0		
				 -BL02 Navy	+\$0		
				 -RD03 Brick	+\$0		

Note: Ganging Glides available and standard on armless version only.

Note: Bottom cover matches seat polycolor.

Polycolor	List	Glides	List	Dolly	List
-A-polycolor # Arm polycolor	+\$5	-NGLD Glideless option	-\$5	-TD2DLY Dolly	+\$306
-B-polycolor # Back polycolor	+\$5				
-S-polycolor # Seat polycolor	+\$5				

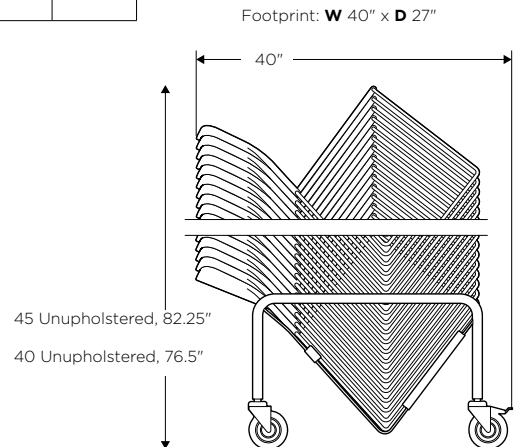

MODEL CODE

Example: TD2 — A — BK01 — CHM (new format code)

Model # Arm Poly Frame
 color

Armless
Ganging Dimensions

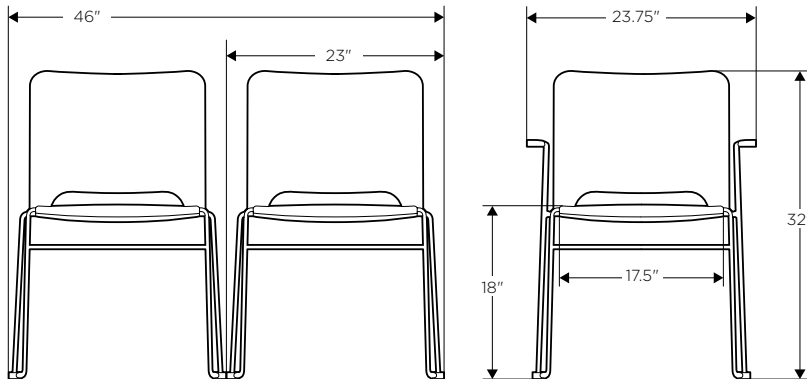

Dimensions	W	D	H
Overall	23.75" (w/arms) 23" (w/o arms)	23.75"	32"
Seat	17.5"	16.75"	18"
Back	17.5"	N/A	14"

Upholstery	Back	Seat	Backshell
COM	N/A	N/A	N/A
Shipping	Carton Wt.	FedEx Wt.	
	14 lbs.	121 lbs.	



Tibidi w/ Upholstered Seat (TD2-S)

Stacking | Guest | Multi-use



Tibidi Core Features:

- HD Stacker with Upholstered Seat
- Stacks 25 High on Dolly
- 275 lb. Weight Capacity
- 7 Year Limited Warranty



Note: Green font color indicates default build for "most popular" configuration of this spread.

1. Model	
Code	List
TD2-S	\$291

2. Arms		
Code		List
 -N (No arms)		+\$0
 -A (With arms)		\$70

Note: Ganging Glides available and standard on armless version only.

3. Polycolor (Arms, Back and Seat match)		
Code		List
 -BK01 Modern Black		+\$0
 -GN04 Moss		+\$0
 -BR01 Sand		+\$0
 -WT03 Snow White		+\$0
 -BL04 Glacier		+\$0
 -GR05 Fog		+\$0
 -BL02 Navy		+\$0
 -RD03 Brick		+\$0

Note: Bottom cover matches seat polycolor.

4. Upholstery	
Fabric Application Test Required	
Code	List
• Grade 2 / Grade-in A	+\$30
• Grade 3 / Grade-in B	+\$45
• Grade 4 / Grade-in C	+\$60
• Grade-in D	+\$75
• Grade-in E	+\$90

Fabric Application Testing is required for non-approved materials. Check with OM Seating for approved materials. [Click here](#) for Fabric Application Testing policy.

Polycolor	List
-A-polycolor # Arm polycolor	+\$5
-B-polycolor # Back polycolor	+\$5

Glides	List
-NGLD Glideless option	-\$5

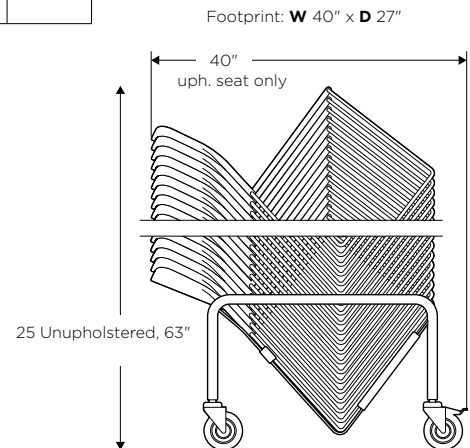

Dolly	List
-TD2DLY Dolly	+\$306



MODEL CODE

Example: TD2-S -- A - BK01 - 2570 - CHM (new format)

Model # Arm Poly color Seat uph. Frame

5. Frame Finish		
	Code	List
	-CHM* Chrome	\$0
	-BLK Black	+\$0
	-WHT White	+\$0

*Most durable option for frequent stacking / unstacking.

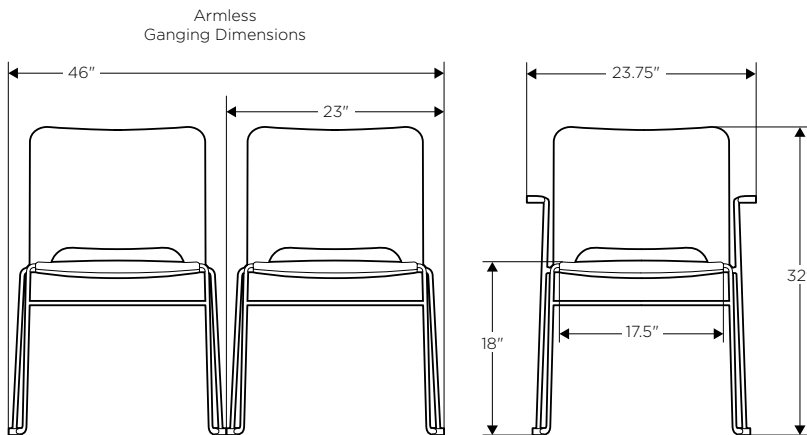

Dimensions	W	D	H
Overall	23.75" (w/arms) 23" (w/o arms)	23.75"	32"
Seat	17.5"	16.75"	18"
Back	17.5"	N/A	14"

Upholstery	Back	Seat	Backshell
COM	N/A	N/A	N/A
Shipping	Carton Wt.	FedEx Wt.	
	14 lbs.	121 lbs.	



Tibidi Fully Upholstered (TD2-F)













Stacking | Guest | Multi-use

Tibidi Core Features:

- HD Stacker Fully Upholstered
- Stacks 25 High on Dolly
- 275 lb. Weight Capacity
- 7 Year Limited Warranty



Note: Green font color indicates default build for "most popular" configuration of this spread.

1. Model		2. Arms		3. Upholstery Fabric Application Test Required		4. Frame Finish	
Code	List	Code	List	Code	List	Code	List
TD2-F	\$291	 -N No arm	+\$0	• Grade 2 / Grade-in A	+\$55	 -CHM* Chrome	\$0
		 -A (With arms) Choose a Polycolor for the arms		• Grade 3 / Grade-in B	+\$75	 -BLK Black	+\$0
		 A-BK01 Modern Black	+\$70	• Grade 4 / Grade-in C	+\$95	 -WHT White	+\$0
		 A-GN04 Moss	+\$70	• Grade-in D	+\$115	*Most durable option for frequent stacking / unstacking.	
		 A-BR01 Sand	+\$70	• Grade-in E	+\$135		
		 A-WT03 Snow White	+\$70	Fabric Application Testing is required for non-approved materials. Check with OM Seating for approved materials. Click here for Fabric Application Testing policy.			
		 A-BL04 Glacier	+\$70	Note: Bottom cover polycolor: • Black on CHM and BLK frames • White on WHT frames			
		 A-GR05 Fog	+\$70				
		 A-BL02 Navy	+\$70				
		 A-RD03 Brick	+\$70				

Note: Ganging Glides available and standard on armless version only.

Glides	List	Mix and Match Seat and Back Upholstery	List	Dolly	List
-NGLD Glideless option	-\$5	-S Fabric Code Seat upholstery	+\$10	-TD2DLY Dolly	+\$306
		-B Fabric Code Back upholstery	+\$10		

