

Werksy[®]

Features:

- Begins @ \$514 (WY2-G)
- Multi-faceted shell chair that features 3 different modes to fit the way you work!
- Visitor: Not your average guest chair – elegant lines to dress up any waiting/guest area
- Tasker: Simple tasking with flair – tilt motion seat for training & hoteling stations
- Rocker: Add a little play to your day – Height adjustable rocker with an auto-return cylinder!
- Designed by Henner Jahns of Gecco Vision







Werksy® Guest (WY2-G)

Visitor | Guest seating

Werksy Guest Core Features:

- One piece shell chair
- Standard with glides
- Floor stacks 4 high (undersat cover protects seats)
- 300 lb. Weight Capacity
- Lifetime Limited Warranty

Note: Green font color indicates default build for "most popular" configuration of this spread.

1. Model		2. Polyshell Color		3. Upholstery <i>NOT available without upholstery</i>			4. Frame Finish		
Code	List	Code		Code	Seat (S-) List	Full (F-)** List	Code	List	
WY2-G	\$514		-BK01 Modern Black <i>(formerly -PSB)*</i>		• Grade 1 / C.O.M.	+\$0	+\$33	-BLK Black powdercoat	+\$0
			-GR08 Noble Grey <i>(formerly -PSG Palladium Grey)*</i>		• Grade 2 / Grade-in A	+\$10	+\$53	-GRY Grey powdercoat	+\$0
			-WT06 Silk White <i>(formerly -PSW Arctic White)*</i>		• Grade 3 / Grade-in B	+\$20	+\$73	-CHM Chrome	+\$30
					• Grade 4 / Grade-in C	+\$30	+\$93		
					• Grade 5 / Grade-in D	+\$40	+\$113		
					• Grade-in E	+\$50	+\$133		
					• Werksy Quilt	+\$69	+\$135		
					• LG1 Evita / C.O.L.	+\$110	+\$210		
					• LG2 Lena - LDEL, LLUT, LORC only*	+\$120	+\$220		
					• LG3 Vulcano - LMIT, LSTG only*	+\$130	+\$240		
					Seat Upholstery	Full Upholstery			
									

Please contact an OM representative for color chips.

* Color code/name change only. There is NO change to actual color of the original polyshell.

*For NON In-Stock colors, check with OM Seating for additional pricing details.

**Note: Fabric: Application Testing Required on non-approved materials for full (-F) upholstery option.

MODEL CODE

Example: WY2-G – BK01 – S-1020 – BLK (new format) = WY2G – PSB – S-1020 – BLK – GLD (original formula)

Model #	Polyshell finish	Uph.	Frame finish	Model #	Polyshell	Full uph.	Frame finish	Other options
---------	---------------------	------	-----------------	---------	-----------	--------------	-----------------	------------------

* For even more options, please refer to penultimate page of this price guide.

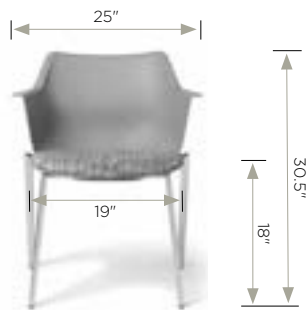

Dimensions	W	D	H
Overall	25"	25"	30.5"
Seat	19"	18.5"	18"
Back	14"	N/A	15"

Upholstery	Seat	Full
COM	0.75 yd.	1.5 yds.
Shipping	Carton Wt.	FedEx Wt.
	35 lbs.	195 lbs.





Werksy® 4-Star (WY2-4S)

Werksy 4-Star Core Features:

- One piece shell chair
- Simple, Rocking-tilt mechanism
- 300 lb. Weight Capacity
- Lifetime Limited Warranty

Note: Green font color indicates default build for "most popular" configuration of this spread.

1. Model		2. Mechanism		3. Polyshell Color		
Code	List	Code	List	Code		List
WY2-4S	\$534	-GSb (formerly WY1GL) Guest Swivel • Height Adjustable	+\$0		-BK01 Modern Black (formerly -PSB)*	+\$0
		-T1a (formerly WY2GL) Tilt Mechanism • Height Adjustable • Light tilt motion	+\$28		-GR08 Noble Grey (formerly -PSG Palladium Grey)*	+\$25
					-WT06 Silk White (formerly -PSW Arctic White)*	+\$25



Please contact an OM representative for color chips.

* Color code/name change only. There is NO change to actual color of the original polyshell.

MODEL CODE

Example: WY2-4S - T1a - BK01 - S-1020 - STDB (new format) = WY2GL - PSB - S-1020 - WB5 - SP-B - TC (original format)

Model # Mech. Polyshell Uph. Base pkg. Model # Polyshell Uph. Cylinder Base pkg. Caster

4. Upholstery <i>NOT available without upholstery</i>		
Code	Seat (S-) List	Full (F-) List
• Grade 1 / C.O.M.	+\$0	+\$33
• Grade 2 / Grade-in A	+\$10	+\$53
• Grade 3 / Grade-in B	+\$20	+\$73
• Grade 4 / Grade-in C	+\$30	+\$93
• Grade 5 / Grade-in D	+\$40	+\$113
• Grade-in E	+\$50	+\$133
• Werksy Quilt	+\$69	+\$135
• LG1 Evita / C.O.L.	+\$110	+\$210
• LG2 Lena - LDEL, LLUT, LORC only*	+\$120	+\$220
• LG3 Vulcano - LMIT, LSTG only*	+\$130	+\$240
Seat Upholstery	Full Upholstery	
		

*For NON In-Stock colors, check with OM Seating for additional pricing details.

Note: Fabric Application Testing Required on non-approved materials for full (-F) upholstery option.

5. Base Packages (includes cylinder, base, and casters)	
Code	List
-STDB (formerly -SP-B) Standard Seat Height Package (Black) (Seat height: 16.5" - 20.5") • Cylinder: 4" Black (4BCE) • Base: 4-star black (27BL4)	+\$0
-STDP (formerly -SP-P) Standard Seat Height Package (Polished) (Seat height: 16.5" - 20.5") • Cylinder: 4" Chrome (4CCE) • Base: 4-star Polished (27PL4)	+\$20
Fixed Height Base Packages	
-FHB Fixed Height Package (Black) (Seat height: 18.5") • Cylinder: 5" Black (5BCE) • Base: 4-star Black (27BL4)	+\$20
-FHP Fixed Height Package (Polished) (Seat height: 18.5") • Cylinder: 5" Chrome (5CCE) • Base: 4-star Polished (27PL4)	+\$40

* For even more options, please refer to penultimate page of this price guide.



Dimensions	W	D	H
Overall	27.25"	27.25"	29.5" - 33.5"
Seat	19"	18.5"	16.5"-20.5"
Back	14"	N/A	15"

Upholstery	Seat	Full
COM	0.75 yd.	1.5 yds.
Shipping	Carton Wt.	FedEx Wt.
	36 lbs.	101 lbs.



Werksy® Multi-tasker (WY2-T)

Hoteling | Light Multi-tasking

Werksy Multi-tasker Core Features:



- One piece shell chair
- Simple, Rocking-tilt mechanism
- 300 lb. Weight Capacity
- Lifetime Limited Warranty

Note: Green font color indicates default build for "most popular" configuration of this spread.

1. Model		2. Mechanism		2. Polyshell Color	
Code	List	Code	List	Code	List
WY2-T	\$514	-GSb (formerly WY1T) Guest Swivel • Height Adjustable	+\$0	-BK01 Modern Black (formerly -PSB)*	+\$0
		-T1a (formerly WY2T) Tilt Mechanism • Height Adjustable • Light tilt motion	+\$28	-GR08 Noble Grey (formerly -PSG Palladium Grey)*	+\$25
				-WT06 Silk White (formerly -PSW Arctic White)*	+\$25

Please contact an OM representative for color chips.



* Color code/name change only. There is NO change to actual color of the original polyshell.

Casters and Glides		List
	-50SS (formerly -SS) 50mm safety soft casters (minimizes chair movement when NOT in use.)	+\$25
	-50R (formerly -REV) 50mm reverse braking caster (restricts chair movement when chair IS in use.)	+\$35
	-GLDR (formerly -G) Glides	+\$0

MODEL CODE

Example: WY2-T - T1a - BK01 - S-1020 - SPDB (new format) = WY2T - PSB - S-1020 - WB5 - WB25 - 55MSB (original format)

Model # Mech. Polyshell Uph. Base pkg. Model # Polyshell Uph. Cylinder Base Caster

4. Upholstery <i>NOT available without upholstery</i>		
Code	Seat (S-) List	Full (F-) List
• Grade 1 / C.O.M.	+\$0	+\$33
• Grade 2 / Grade-in A	+\$10	+\$53
• Grade 3 / Grade-in B	+\$20	+\$73
• Grade 4 / Grade-in C	+\$30	+\$93
• Grade 5 / Grade-in D	+\$40	+\$113
• Grade-in E	+\$50	+\$133
• Werksy Quilt	+\$69	+\$135
• LG1 Evita / C.O.L.	+\$110	+\$210
• LG2 Lena - LDEL, LLUT, LORC only*	+\$120	+\$220
• LG3 Vulcano - LMIT, LSTG only*	+\$130	+\$240
Seat Upholstery	Full Upholstery	
		

*For NON In-Stock colors, check with OM Seating for additional pricing details.

Note: Fabric Application Testing Required on non-approved materials for full (-F) upholstery option.

5. Base Packages (includes cylinder, base, and casters)	
Code	List
-STDB Standard Seat Height Package (Black) (Seat height: 16" - 21") • Cylinder: 5" Black (5BWY) • Base: 25" Black powdercoat (25BWY) • Casters: 55mm Black two-tone multi-surface (55MSB)	+\$0
-STDP Standard Seat Height Package (Polished) (Seat height: 16" - 21") • Cylinder: 5" Black (5BWY) • Base: 25" Two-tone polished aluminum (25PWY) • Casters: 55mm Black two-tone multi-surface (55MSB)	+\$30
-STDW Standard Seat Height Package (White) (Seat height: 16" - 21") • Cylinder: 5" White (5WWY) • Base: 25" White powdercoat (25WWY) • Casters: 55mm White two-tone multi-surface (55MSW)	+\$40
-STDG Standard Seat Height Package (Grey) (Seat height: 16.5" - 21") • Cylinder: 5" Grey (5GWY) • Base: 25" Grey powdercoat (25GWY) • Casters: 55mm White two-tone multi-surface (55MSG)	

* For even more options, please refer to penultimate page of this price guide.



Dimensions	W	D	H
Overall	25"	25"	29.5 - 34.5"
Seat	19"	18.5"	16-21"
Back	14"	N/A	15"

Upholstery	Seat	Full
COM	0.75 yd.	1.5 yds.
Shipping	Carton Wt.	FedEx Wt.
	36 lbs.	101 lbs.



Werksy® Stool (WY2-TS)

Light Multi-tasker Stool

Werksy Stool Core Features:



- One piece shell chair
- Simple, light multi-tasker stool
- 300 lb. Weight Capacity
- Lifetime Limited Warranty

Note: Green font color indicates default build for "most popular" configuration of this spread.

1. Model		2. Mechanism		2. Polyshell Color	
Code	List	Code	List	Code	List
WY2-TS	\$632	-GSb Fixed Mechanism • Height Adjustable	+\$0	-BK01 Modern Black (formerly -PSB)*	+\$0
				-GR08 Noble Grey (formerly -PSG Palladium Grey)*	+\$25
				-WT06 Silk White (formerly -PSW Arctic White)*	+\$25

Please contact an OM representative for color chips.



* Color code/name change only. There is NO change to actual color of the original polyshell.

Casters and Glides		List	Footring		List
	-50SS (formerly -SS) 50mm safety soft casters (minimizes chair movement when NOT in use.)	+\$25	-20TLB 20" Black Turn-lock Footring	+\$0	
	-50R (formerly -REV) 50mm reverse braking caster (restricts chair movement when chair IS in use.)	+\$35	-20TL 20" Chrome Turn-lock Footring	+\$20	
	-GLDR (formerly -G) Glides	+\$0			

MODEL CODE

Example: WY2-TS - T0b - BK01 - S-1020 - 10TLB (new format) = WY1T - PSB - S-1020 - OC10 - B27TL - SC (original format)

Model # Mech. Polyshell Uph. Base pkg. Model # Polyshell Uph. Cylinder Base Caster

4. Upholstery <i>NOT available without upholstery</i>		
Code	Seat (S-) List	Full (F-) List
• Grade 1 / C.O.M.	+\$0	+\$33
• Grade 2 / Grade-in A	+\$10	+\$53
• Grade 3 / Grade-in B	+\$20	+\$73
• Grade 4 / Grade-in C	+\$30	+\$93
• Grade 5 / Grade-in D	+\$40	+\$113
• Grade-in E	+\$50	+\$133
• Werksy Quilt	+\$69	+\$135
• LG1 Evita / C.O.L.	+\$110	+\$210
• LG2 Lena - LDEL, LLUT, LORC only*	+\$120	+\$220
• LG3 Vulcano - LMIT, LSTG only*	+\$130	+\$240
Seat Upholstery	Full Upholstery	
		

*For NON In-Stock colors, check with OM Seating for additional pricing details.

Note: Fabric Application Testing Required on non-approved materials for full (-F) upholstery option.

5. Base Packages (includes cylinder, base, and casters)	
Code	List
Black Base Packages:	
-8TLB Low Stool Height Package (Black) (Seat height: 21" - 29") • Cylinder: 8" Black (8BAT) • Footring: 20" Black Turn-lock footring (20TLB) • Base: 27" Black nylon (27BM) • Casters: 65mm Grey two-tone multi-surface (65MS)	+\$0
-10TLB Standard Stool Height Package (Black) (Seat height: 25" - 35") • Cylinder: 10" Chrome (10CHD) • Footring: 20" Black Turn-lock footring (20TLB) • Base: 27" Black nylon (27BM) • Casters: 65mm Grey two-tone multi-surface (65MS)	+\$0
Polished Base Packages:	
-8TLP Low Stool Height Package (Polished) (Seat height: 21" - 29") • Cylinder: 8" Chrome (8CHD) • Footring: 20" Chrome Turn-lock footring (20TL) • Base: 27" Polished aluminum (27PM) • Casters: 65mm Grey two-tone multi-surface (65MS)	+\$60
-10TLP Standard Stool Height Package (Polished) (Seat height: 25" - 35") • Cylinder: 10" Chrome (10CHD) • Footring: 20" Chrome Turn-lock footring (20TL) • Base: 27" Polished aluminum (27PM) • Casters: 65mm Grey two-tone multi-surface (65MS)	+\$60

* For even more options, please refer to penultimate page of this price guide.

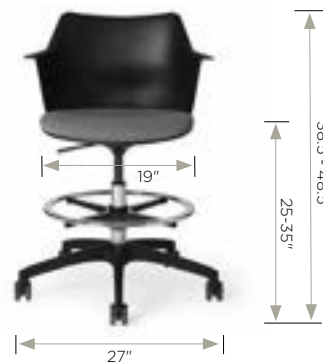

*specs are based on 10TL base packages

Dimensions	W	D	H
Overall	27"	27"	38.5 - 48.5"
Seat	19"	18.5"	25-35"
Back	14"	N/A	15"

Upholstery	Seat	Full
COM	0.75 yd.	1.5 yds.
Shipping	Carton Wt.	FedEx Wt.
	36 lbs.	101 lbs.





Werksy® Rocker (WY2-R)

Rocker | Hoteling | Guest seating

Werksy Rocker Core Features:

- One piece shell rocking chair
- Auto-return rocker
- 300 lb. Weight Capacity
- 12 Year Warranty

Note: Green font color indicates default build for "most popular" configuration of this spread.

1. Model		2. Mechanism		2. Polyshell Color	
Code	List	Code	List	Code	List
WY2-R	\$849	-GSb Fixed Mechanism • Height Adjustable	+\$0	 -BK01 Modern Black (formerly -PSB)*	+\$0
				 -GR08 Noble Grey (formerly -PSG Palladium Grey)*	+\$25
				 -WT06 Silk White (formerly -PSW Arctic White)*	+\$25



Please contact an OM Representative for color chips.

* Color code/name change only. There is NO change to actual color of the original polyshell.

MODEL CODE

Example: WY2-R - TOB - BK01 - S-1020 - SP-B (new format) = WY2R - PSB - S-1020 - WBA5 - BLK (original format)

Model # Mech. Polyshell Uph. Base pkg. Model # Polyshell Uph. Cylinder Rocker pkg.

3. Upholstery <i>NOT available without upholstery</i>		
Code	Seat (S-) List	Full (F-) List
• Grade 1 / C.O.M.	+\$0	+\$33
• Grade 2 / Grade-in A	+\$10	+\$53
• Grade 3 / Grade-in B	+\$20	+\$73
• Grade 4 / Grade-in C	+\$30	+\$93
• Grade 5 / Grade-in D	+\$40	+\$113
• Grade-in E	+\$50	+\$133
• Werksy Quilt	+\$69	+\$135
• LG1 Evita / C.O.L.	+\$110	+\$210
• LG2 Lena - LDEL, LLUT, LORC only*	+\$120	+\$220
• LG3 Vulcano - LMIT, LSTG only*	+\$130	+\$240
Seat Upholstery	Full Upholstery	
		

*For NON In-Stock colors, check with OM Seating for additional pricing details.

Note: Fabric Application Testing Required on non-approved materials for full (-F) upholstery option.

4. Base Packages (includes cylinder, base, and casters)	
Code	List
-RKB Rocker Package (Black) (Seat height: 16" - 21") • Cylinder: 5" Black auto-return (5BAR) • Base: 27" Black powdercoat (27BR)	+\$0
-RKC Rocker Package (Chrome) (Seat height: 16" - 21") • Cylinder: 5" Black auto-return (5BAR) • Base: 27" Chrome rocker (27CR)	+\$45

* For even more options, please refer to penultimate page of this price guide.

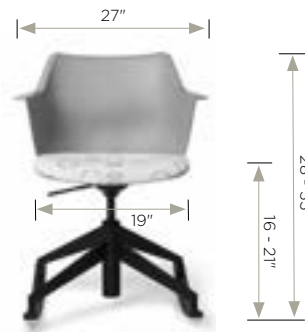

Dimensions	W	D	H
Overall	27"	27"	28 - 33"
Seat	19"	18.5"	16-21"
Back	14"	N/A	15"

Upholstery	Seat	Full
COM	0.75 yd.	1.5 yds.
Shipping	Carton Wt.	FedEx Wt.
	48 lbs.	195 lbs.